

# AKO

FENCING

Entire range 2026



Smart control.  
Powerful  
technology.

## Patented innovation:

Maximum stability with the premium post from AKO



### Innovative mix of materials:

Thanks to the combination of thermoplastic and fibreglass fibres, it is possible to reduce the weight and at the same time significantly increase the rigidity while maintaining the proven diameter.

### Available in two colours:

blue for sheep/wolf nets for better visibility for humans and animals. Anthracite for poultry nets for discreet colour adaptation in gardens.

### Curious to find out more?

Then see for yourself – to meet the highest demands of professional animal husbandry, all of our PREMIUM nets are already equipped with the new posts.



Premium

Standard

### Reliable and upright positioning:

compared to conventional posts, PREMIUM posts are significantly stiffer and less susceptible to bending.

### Guaranteed UV resistance & durability:

the glass fibre-reinforced material withstands even the most adverse weather conditions

### Use of injection moulding technology:

the head insulator and ground prongs are inseparably moulded in one production process and guarantee a permanent hold.

### Improved ground prongs:

extended, galvanised ground prongs provide even more stability. Available in single and double prong design

New & only for a short time:  
our top nets with premium post at an introductory price



## AKO OviNet Premium

- extremely durable PREMIUM posts with fibreglass reinforcement and galvanised double prong for maximum stability and weather resistance
- the pasture net is ideal for mobile use and can be easily moved to different pasture areas thanks to its low weight
- flexible to use in two heights, it adapts perfectly to the needs of sheep, goats and other pasture animals
- the highly visible, high-contrast colouring ensures a secure boundary and helps to reliably keep animals inside the fence
- the robust mesh made from welded plastic strands combines stability with flexibility to withstand changing conditions

Made in the EU



3-year UV stability warranty

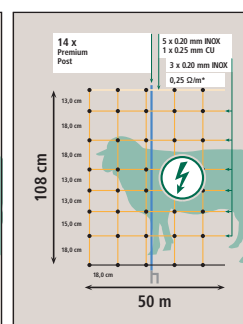
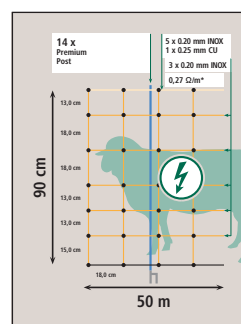

Ref. no.	Ground Spike	Length	Height	Colour	Qty Posts	matching replacement post	€
27837	Double Prong	50 m	90 cm	orange / white	14	27805 1	30
27838	Double Prong	50 m	108 cm	orange / white	14	27807 1	30

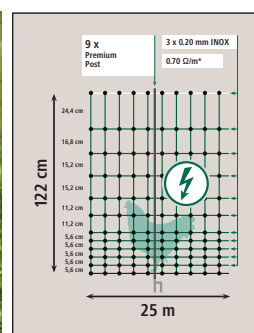

## AKO Poultry Netting Premium

- ideal for mobile use - easy and flexible to use on different grazing areas
- particularly stable PREMIUM posts with galvanised double prongs ensure stability and minimal bending
- posts permanently installed in the net enable quick, tool-free assembly
- particularly small mesh width in the lower area of the net
- Stainless steel conductors ensure reliable power supply over the entire length of the netting

New product

NEW

Made in the EU



3-year UV stability warranty



Ref. no.	Ground Spike	Length	Height	Colour	Qty Posts	matching replacement post	€
292415	Double Prong	25 m	122 cm	green / white	9	292408 1	18



## Information



Promotional Articles	2
General Information	7

## Fence devices



Smart Fence Devices	20
230 Volt Power Supplies	23
12 / 230 V Duo Units	31
12 V Battery Units	39
Solar Units	51
Solar Modules	62
Metal Battery Cases	65
9 V Battery Energisers	67
Hobby Devices	74
Starter Kits	48

## Device Accessories



Fence Device Batteries	78
Testing and Control Equipment	82
Connection and Grounding Accessories	86
Fencing Accessories	94
Warning Signs	95
Pastured Reels	96
Post Reel Systems	99

## Conductors and Accessories



Tapes	106
Ropes	111
Polywires	114
Tape, Rope and Poly Wire Connectors	118

## Permanent Fencing Accessories



Fence Wires	124
Premium Horse Wire / TopLine Horse Wire	126
Permanent Fencing Accessories	128
Wire Connectors	131

## Fencing Posts



Wooden Posts	134
Recycled Posts	138
T-Post System	141
Metal Posts	150
Fibreglass Posts	153
Plastic Posts	156

## Insulators



Ring Insulators	165
Slot Insulators	168
Special Insulators	169
Corner/strain insulators	170
Tape Insulators	172
Rope Insulators / Wire Insulators	174
Insulators with metric thread	176
Additional Insulators	178
Offset Insulators	180

## Gate Components



Gate insulators	182
Gate Handles	186
Gate Systems and Accessories	190

## Pasture Gates, Panels and Racks



Pasture Gates	195
Paddock Panels	200
Fodder Racks	206

## Fence Netting



Sheep Netting	213
Wolf Defence	220
Wild Animal Deterrent	230
Small Animal Nets	233
Poultry Netting	234
Net Accessories	238

## Keyword Index

Keyword Index	246
---------------	-----

# Top New Products 2026



**Always up to the minute!**

Always keep up to date!

For all new products and offers, simply scan the code below, or visit us at [www.ako-agrar.de](http://www.ako-agrar.de).

We are also happy to advise you about this personally via telephone on in the pasture fence calculator chat function at any time.



You will find these and other new products in this catalogue!

**Smart Technology**  
App-controlled fence devices

**Smart Energiser** 





**Innovative pasture nets**  
Sheep and poultry nets for maximum flock safety



**Premium components**  
Accessories for the highest quality standards



**Expertise in permanent fencing**  
extremely sturdy and long-lasting components



## S 6



- optimised for permanent, maintenance-free operation right through the main pasture season
- with High/Low/Off switch
- power saving switch for when battery voltage fails
- integrated lightning protection
- intelligent, modern battery management with deep discharge protection – device functions even during extended periods of bad weather
- excellent level of efficiency – therefore a longer battery life
- very robust, weather-resistant, water-tight casing with carrying handle
- fast and easy to install
- channel integrated into the housing for post mounting
- microprocessor controlled
- very bright, clearly visible LED light
- corresponds to applicable EU safety standards

0,8 Joule



Made in Germany



5-year warranty



function indicator LED (green) plus solar operation LED (blue) plus battery warning LED (red)

### AKO S 6

- highly effective solar device for normal fences without vegetation
- ideal for horse and cattle paddocks
- 5-year warranty\*



Included in Delivery: 1 x compact solar device S 6 (fully assembled) \*, 1 x AGM battery, 12 Volt, 7 Ah (441130)\*, 1 x permanently mounted, crystalline solar module, 12 Volt, 8 Watt \*, 1 x 230 volt battery mains charger (371032), 1 x fence connector cable, 1 x ground connector cable, 1 x two-part ground/ installation spear (442385), 1 x warning sign, \* Warranty: solar fence device (5 year warranty), solar module (5 year performance warranty), 12 volt battery (6 month warranty)

Ref. no.			€
372948	1	50	

Model	Ref. no.											
S 6	372948	0.8 J	0.6 J	10,800 V	10,200 V	4,300 V	18 km	6 km	1.7 km	0.2 km	1	31 - 43 mA

Important: If ground is dry, several additional ground rods must be used.

# X2 smart

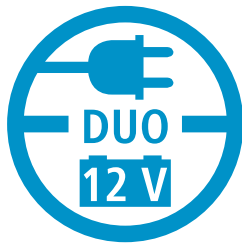

- very bright, clearly visible LED light
- Plug Connector with Screw Fuse
- (suitable for metal box 44656 and 44650)
- optimised consumption thanks to energy saving mode – saves battery power in fences in good condition. Also intelligent battery management for when battery voltage decreases.
- deep discharge protection for the 12 volt battery
- microprocessor controlled
- robust, impact-resistant, UV-resistant and weather-resistant housing thanks to the use of high-quality plastics
- solar backup possible
- integrated hanging device for wall mounting
- corresponds to applicable EU safety standards

### Smart fence device technology:

- constant control (24/7)
- free app download & no follow-on costs for the app, as well as mobile data transfer for the app
- Control via mobile phone or browser
- direct cloud connection (no WiFi required and no connection to a different central device, e.g. gateway, is needed)
- worldwide control (ON/OFF, GPS location) and monitoring of fence systems
- if the pre-set minimum protective voltage is not reached, the user is notified with a real-time alarm message



2,8 Joule

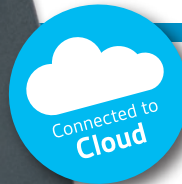

Made in Germany



multi-colour LED bar graph display for output voltage and battery control

5-year warranty



## AKO X2 smart

- smart Energiser - can be controlled via smartphone app and computer browser
- 12 / 230 Volt DUO unit with efficient output
- with High/Low/OFF switch for 2 different output powers
- for normal fences without vegetation
- 5-year warranty

recommended solar module: 375201 (20 Watt), connection directly to the 12-Volt battery, mounting e.g. on a metal box



Included in Delivery: 1 x fence unit, 1 x 230 volt power pack (371023), 1 x 12 Volt connection cable (E268739), 1 x ground connector cable, 1 x fence connector cable, 1 x warning sign

Ref. no.			€
372868	1	88	

For further information, see page 37.

Model	Ref. no.												
X2 smart	372868	2.8 J	2 J	11,800 V	10,000 V	7,300 V	60 km	15 km	3 km	1.6 km	8	2	68 - 159 mA



- Especially suitable for horse paddocks! End-to-end electrical contact!
- integrated retraction brake ensures controlled retraction of the conductor material and prevents injuries and damage
- patented



Experience the difference compared to conventional gate systems thanks to the braking function!

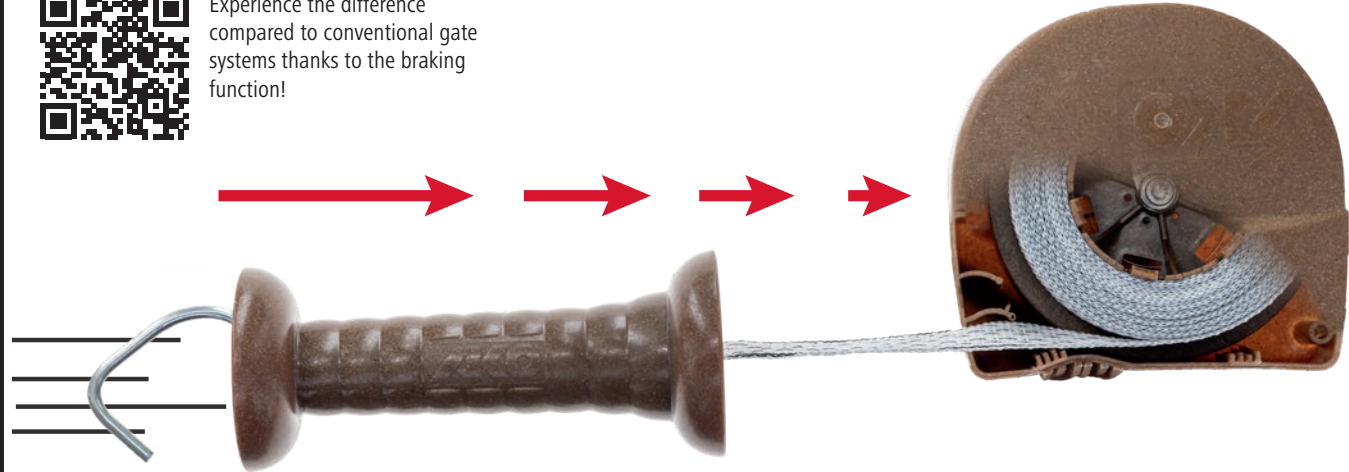

## Gate Set Premium FLEXIGATE green

Innovative technology, sustainable material and a new look - our new flexible gate system for paddock entrances up to 6 m wide

- housing and gate handle made of sustainable bio-based plastic - from 100 % renewable raw materials
- wood look thanks to small natural wood chips in the bio-plastic
- robust housing in a compact and modern design
- connection cable included in the scope of delivery enables ideal contacting and continuous electrification of the gate
- easy and quick mounting on the post by means of enclosed wood screws
- high-quality conductor material with our proven TriCond wires ensures maximum conductivity throughout - available with 40 mm wide tape or 6 mm rope
- the orientation of the 40 mm wide tape can be rotated by 90 degrees in the gate handle and can thus be individually adapted to the hanging direction of the gate handle -> wide tape is always upright and can thus be perceived better
- extendable up to 6 m in length
- can be mounted on both sides (opening to the left or right)



Made in Germany

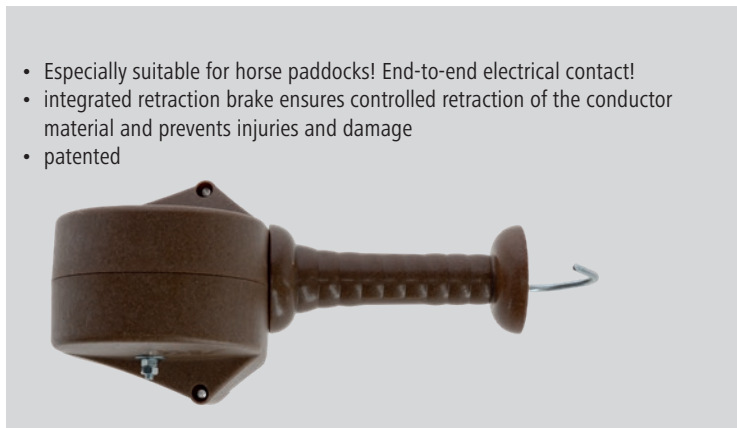

- Especially suitable for horse paddocks! End-to-end electrical contact!
- integrated retraction brake ensures controlled retraction of the conductor material and prevents injuries and damage
- patented

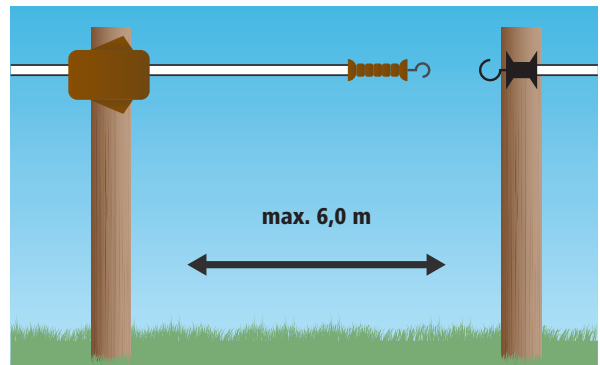

Included in Delivery: 1 x FLEXIGATE green, 1 x connection cable (40 cm) with ribbon or cable connector for optional electrification, 2 x wood screws for mounting on the post

Ref. no.	Description	Colour		€
442398	with 40 mm tape	brown	1	
442399	with 6 mm rope	brown	1	

## Dry Battery Alkaline 9 Volt

- alkaline technology ensures consistently high voltage and a long service life - ideal for use in fence devices
- compatible with all standard 9 Volt fence devices and versatile for cattle, horses, sheep and more
- free from mercury and cadmium
- maintenance-free in use, leak-proof and immediately ready for operation - simply insert, connect and get started reliably



350537: duo pack (2 x 175 Ah)

very good price/performance ratio  
All prices include disposal fee!



Ref. no.	Voltage	Capacity			€
350537	9 V	175 Ah	1	108	

# PlatinumLine

Made in Germany



## Tape PlatinumLine

- the ideal combination of the best conductivity and increased breaking load combined in one conductor material
- extra-thick monofilaments and reinforced outer edges ensure excellent breaking strength and longevity
- maximum conductivity and protection thanks to the use of thick, galvanised copper wires
- UV-stable and weather-resistant
- high-contrast colour combination for optimum visibility for humans and animals

5-year UV stability warranty



- 2 x 200 m length in twin pack
- practical double pack with TOP price/performance ratio



Ref. no.	Length	Width	Colour	max. recommended fence length	Resistance	Number of Conductors	Stainless Steel Ladder	Tin-plated copper conductor	Break Load		€
442828	400 m	12.5 mm	white / blue	13 km	0.16 Ω/m	5	3 x 0,2 mm	2 x 0,25 mm	110 kg	1 120	

## Poly Wire PlatinumLine

- the ideal combination of the best conductivity and increased breaking load combined in one conductor material
- unique braiding for maximum stability and durability with improved elasticity
- the conductor wires running continuously on the surface guarantee optimum contact at all times
- extra-thick copper wires ensure high conductivity and protection
- UV-stable and weather-resistant

5-year UV stability warranty



- 2 x 300 m length in twin pack
- practical double pack with TOP price/performance ratio



woven and therefore extremely robust and resilient

Ref. no.	Length	Colour	max. recommended fence length	Resistance	Number of Conductors	Stainless Steel Ladder	Tin-plated copper conductor	Break Load		€
442829	600 m	white / blue	30 km	0.06 Ω/m	10	6 x 0,2 mm	4 x 0,25 mm	120 kg	1 120	



## Pasture fence advice & service

Personal and professional



# Customer Support Line +49 8086 933-577

Our experts are here to help with any questions about pasture fencing. Whether installation, expansion or troubleshooting – together we will find your solution.

Contact us by phone or send an e-mail to [weidezaun@kerbl.com](mailto:weidezaun@kerbl.com).

## Pasture fence calculator

[www.fenceconfigurator.com](http://www.fenceconfigurator.com)

Pasture fence configuration is no gamble with AKO!

Create your customised material list in just a few steps:

1. Select the animal type and fence type
2. Enter the terrain and fence length
3. Get a material recommendation

Use the integrated map feature for precise length measurement.

## My Manual

[www.my-manual.eu](http://www.my-manual.eu)

Here you can find information about your device:

- Manuals
- Declarations of conformity
- General information

Simply enter the item number of your device and off you go.



## Discover our range of online services

### Browsing catalogue and service pages

If you don't have one of our catalogues to hand, or simply want to browse through our collection with the 'true' catalogue feeling, then our online browsing catalogue is exactly what you need.

The services pages on our website also contain generally useful forms such as repair requests, pick-up requests for dry batteries and return slips.



## Explanation of our packaging and sales units.

MOQ	Pieces / unit	€
1 blister pack	Pack of 6	Price per pack
1 pouch	Pouch of 10	Price per pouch
12 items	Pouch of 12	Price per item
1 pack	Pack of 30	Price per pack
40 items	Pack of 40	Price per item
1 box	Box of 5	Price per box
8 items	Box of 8	Price per item
1 display	Display of 10	Price per display
6 items	6 / Display	Price per item



### Pack units

Possible pack units for 1 OU.



### Pallet

No. of order units (OU) per pallet.



### Forwarder

All items marked with this icon must be shipped by freight carrier due to their scale/size or weight. This means that additional, separate freight costs are required! Optimise freight costs by ordering entire pallet units.



### OU

#### Order unit for retail

Always order a multiple of the number stated (e.g. OU = 12 items, order in lots of 12).



### Items/pack unit

#### No. of items per order unit/pack unit



### Price/€

#### Price per OU

If the OU column is empty or missing, the price is per item. All prices provided are the manufacturer's recommended retail prices and are inclusive of VAT.



### Animal types

You will find animal icons on many products. These indicate usage for certain animal types.



The warranty information in this catalogue is based on the general warranty conditions of AKO-Agrartechnik GmbH & Co. KG. The current version of the general warranty conditions can be found at: <https://www.ako-agrar.com/guarantee>. These can also be sent electronically or by post on request.

# The product ranges from AKO

Alongside our fence devices, we have now also divided our accessories range into three familiar product collections - PREMIUM, EXPERT and CLASSIC - in order to make it easier for you to choose the most suitable product:



## Premium:

Products of the perfectly coordinated Premium line feature the highest quality and a particularly long service life: our articles with Premium character each stand out due to a clear added value in function and material quality and are thus ideally suited for professional use in demanding pasture fencing systems, where they significantly reduce the amount of maintenance required.



## Expert:

A range of functional and long-lasting products that have proven their capabilities over many years in a wide range of applications. Flexibility and efficiency are this product range's strengths.



## Classic:

A range of products with tried-and-tested and robust properties that offers particularly good value for money. These products are suitable for all purposes in professional as well as hobby applications. The CLASSIC products meet the expectations of animal keepers who want solid and functional equipment.

# This is how an electric fence system works!

## An electric fence system consists of:

- A) An electric fence unit that generates regular electric pulses.
  - B) One or more wires that transport electricity (although these do not necessarily have to form a closed loop).
  - C) Insulators that isolate the electricity from earth.
  - D) Permanent or mobile posts that can be used as required.
  - E) The earth of the electric fence unit, which should be buried as deep as possible in damp soil.
- If the animal touches the wire, an electric circuit is closed, i.e. the electric current flows through the animal and the earth back to the unit. The animal consequently receives an unpleasant, though harmless, electric shock and retreats. An electric fence system of this kind is used successfully to pen animals in and also to keep other animals out.

Permanent fence with 230-Volt supply voltage

Mobile fence with 9 Volt or 12 Volt supply voltage

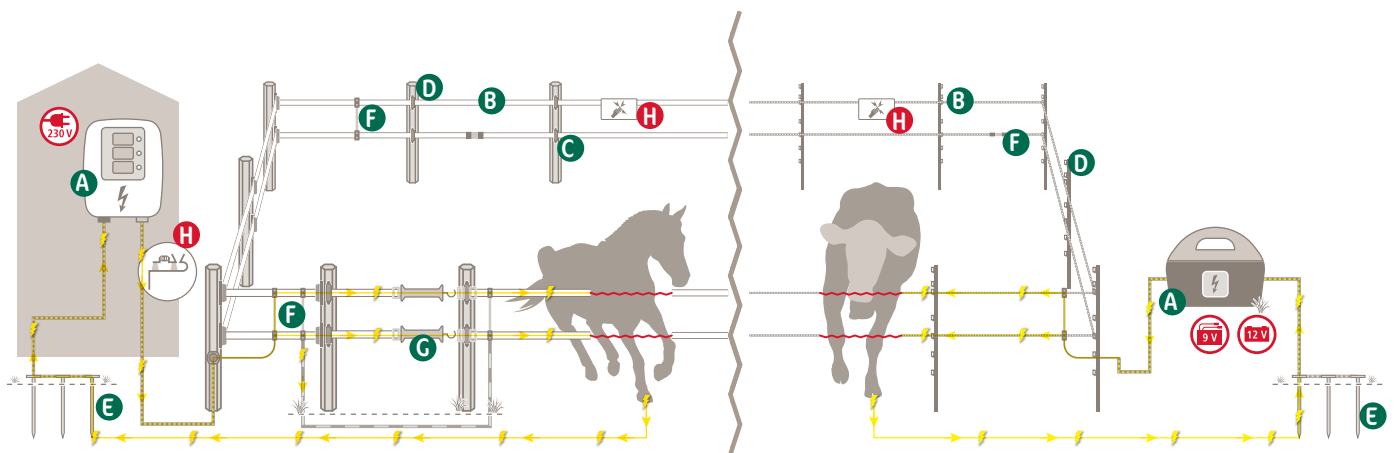

Make sure there are at least 2500 V at every point of the fence.

You can find much more information on our website too!



- A Electric fence device
- B Conductor material
- C Insulators
- D Posts
- E Earthing
- F Connections
- G Gate system
- H Safety components



# How many wires at which height?

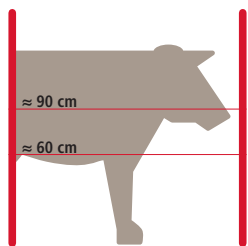

Electric Fence for Dairy Cows  
Recommendation: 10 mm tape, polywire

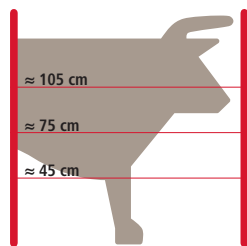

Electric Fence for Bulls, Cattle and Suckler Cows with Calves  
Recommendation: 10 mm tape, polywire

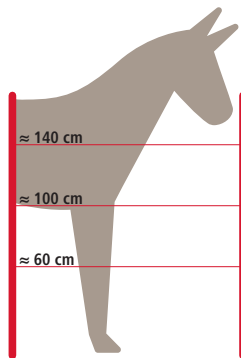

Electric Fence for Big Horses  
Recommendation: rope or tape up to 40 mm

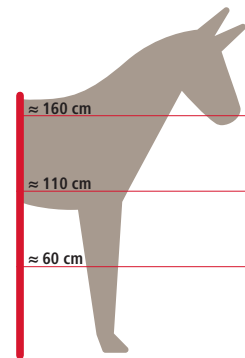

Electric Fence for Jumping Horses  
Recommendation: Rope, Wide Tape up to 40 mm

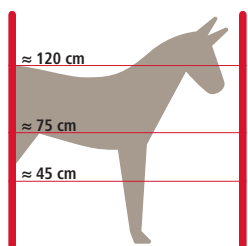

Electric Fence for Small Horses  
Recommendation: 10 mm tape, rope

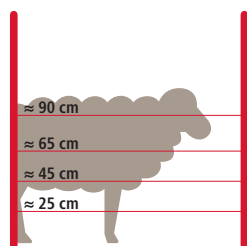

Electric fence for sheep  
Recommendation: sheep netting, wire, polywire

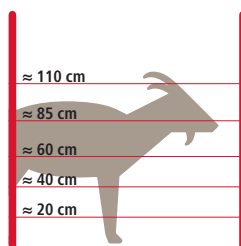

Electric Fences for Goats  
Recommendation: electric wire, polywire

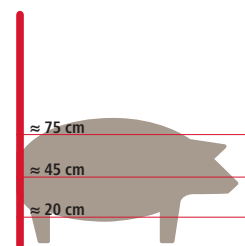

Electric Fences for Pigs  
Recommendation: 10 mm tape, polywire

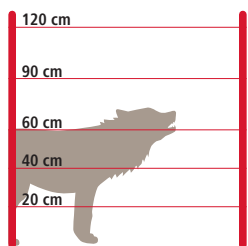

Wolf deterrence  
Recommendation: wolf net (sheep farming), wire, herd guard tape

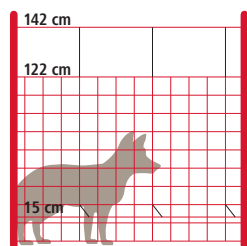

Defence against foxes  
Recommendation: electrifiable poultry net, WolfStop

When keeping domestic pigs, an exterior, wild animal density fence (metal hinge joint fencing) is required in addition to the interior electric fence!

The specifications like fence heights are only approximate and need to be adapted to the animal species you wish to fence in. Please observe regional regulations if applicable!

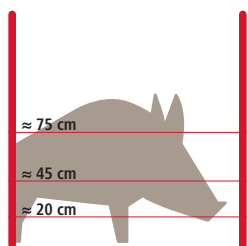

Deterring Wild Boars  
Recommendation: Wild animal deterrent net, 10 mm tape, polywire

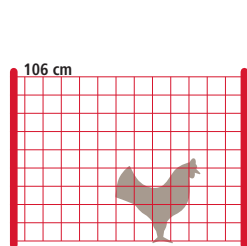

Electric Fences for Hens  
Recommendation: poultry netting, polywire

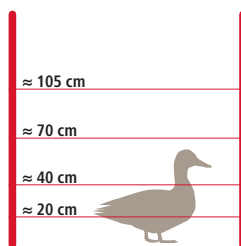

Electric Fences for Geese  
Recommendation: poultry netting, tape, polywire

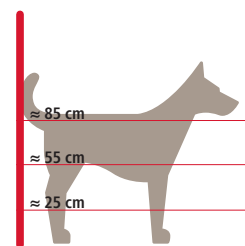

Electric Fences for Tall Dogs  
Recommendation: Hobbyset, polywire

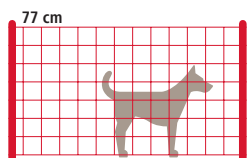

Electric Fences for Small Dogs  
Recommendation: Hobbyset, polywire

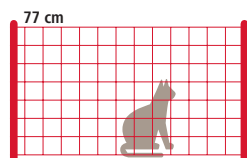

Electric Fences for Cats  
Recommendation: Hobbyset, polywire

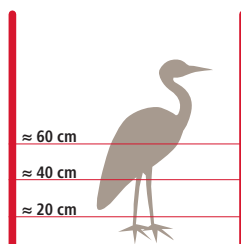

Electric Fence to deter Herons  
Recommendation: Hobbyset, polywire

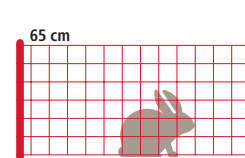

Electric Fence for Rabbits  
Recommendation: rabbit netting, polywire

# The fence device check

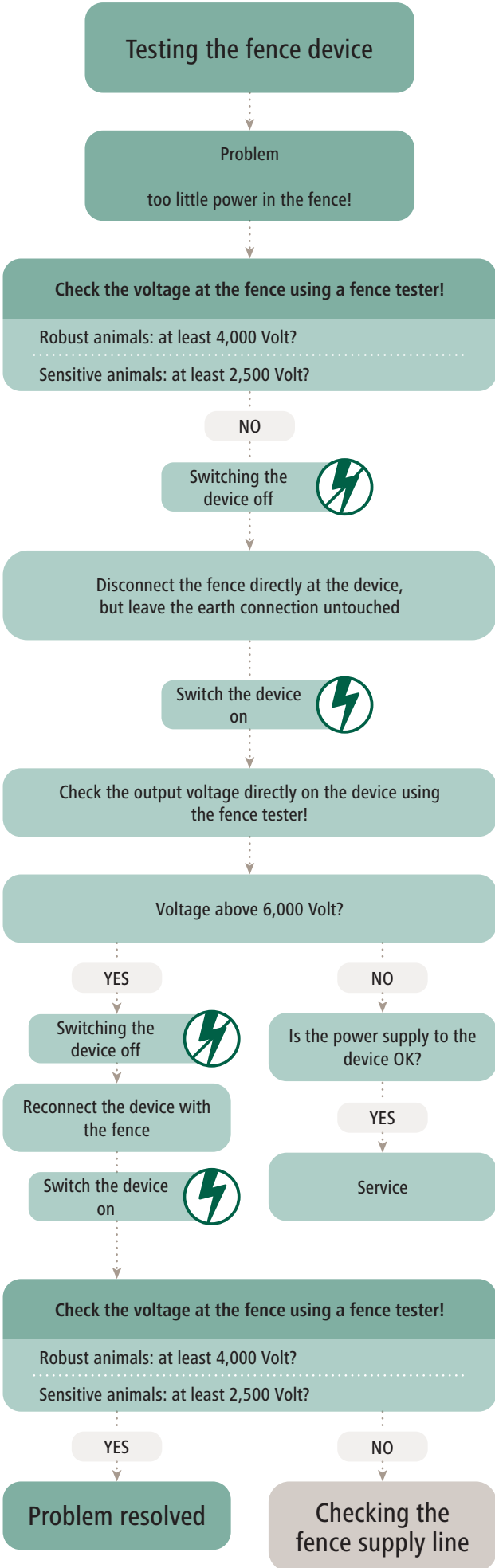

## Tip 1

1. Remove the knurled nuts from the earthing and fence output
2. Contact the earth output on the device using the fence tester's earthing rod
3. Contact the fence output on the device using the fence tester

## Tip 2

1. 9 volt battery: flashing red => battery is flat
2. 12 volt rechargeable battery: flashing red => battery is flat
3. 230 Volt mains power: LED not flashing => no power supply

- replace the 9 Volt battery
- charge the 12 Volt battery
- have the 230 Volt supply checked by a specialist

# The fence supply line & earthing check

## Checking the fence supply line

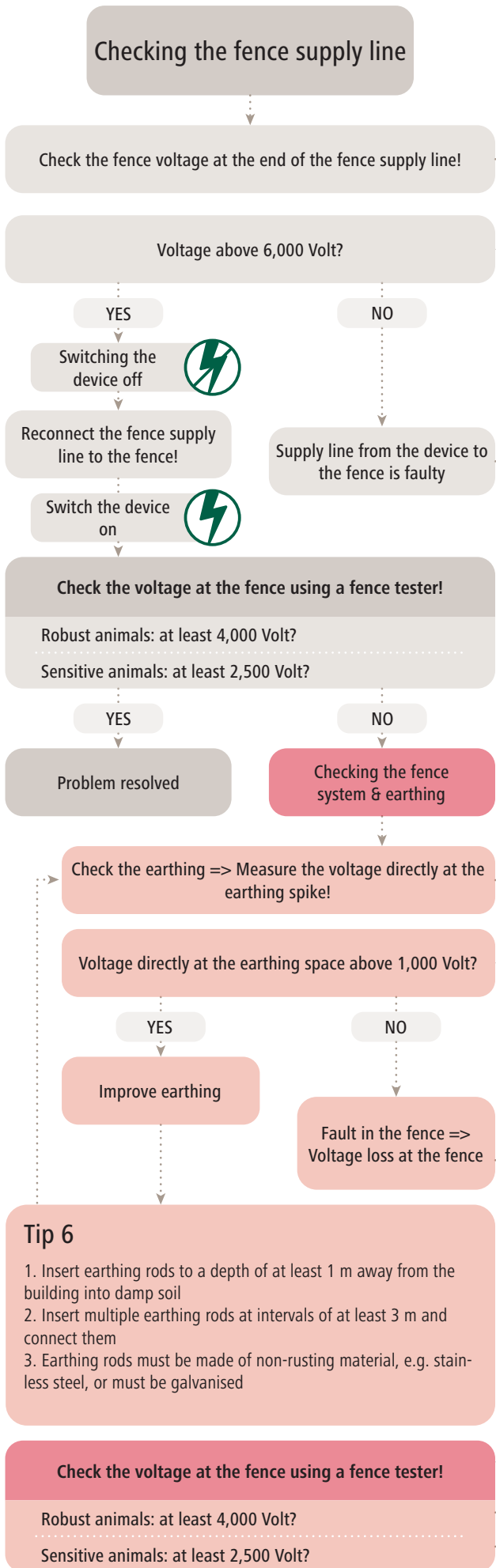

### Tip 3

1. Switch the device off
2. Disconnect the fence supply cable at the fence
3. Switch the device back on
4. Using the fence tester, measure the voltage at the end of the fence supply line cable



### Tip 4

1. **Underground fence supply line**  
The underground cable is faulty => use an underground cable resistant to high voltages
2. **Underground fence supply line**  
Check the fence supply line for diversions / interruptions (e.g. is the supply line contacting the building, e.g. ivy, guttering, shrubbery, etc.)?

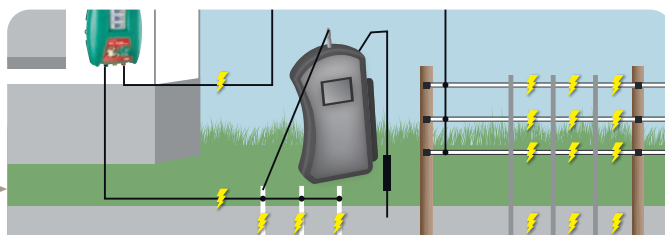

### Tip 5

- How do I measure voltage directly on the earthing rod?**
1. Short-circuit the fence wire approximately 10 m away from the device earthing using iron rods
  2. Check the voltage directly at the earthing rod using a digital voltmeter

### Tip 7

1. Vegetation on the fence => remove it!
2. Conductive material lying on the ground => tie / bind it up
3. Poor conductive material => replace with material that has good conductive properties (< 1 Ohm/m)
4. Conductive material is knotted => use stainless steel ties
5. Insulator breaks through => replace with new insulator
6. Broken metal conductor wires => replace conductive material
7. Improve conductivity => connect conductive material series with each other vertically at intervals of around 200 m

### Tip 6

1. Insert earthing rods to a depth of at least 1 m away from the building into damp soil
2. Insert multiple earthing rods at intervals of at least 3 m and connect them
3. Earthing rods must be made of non-rusting material, e.g. stainless steel, or must be galvanised

# Explanation of technical terms



## Earth

The earth is an important part of the power circuit. To ensure the current can flow from the earth back to the unit unhindered, the earth rod must have the best possible contact with the soil (dry earth barely conducts electricity). Therefore, when inserting the earth rod, choose damp places where possible, or choose earth rods that are sufficiently long to reach deeper, damp layers of earth.



## Shock voltage and pulse energy

The peak of an electric pulse generated by an electric fence unit is known as shock voltage. A high voltage is needed to create a conductive 'channel' between the fence wire and the animal's body. The minimum voltage is around 2500 V. For animals with a thick coat, we recommend 5000 V as the minimum voltage. The current (pulse energy) can now flow through this 'channel'. Therefore, the shock effect depends on the amount of pulse energy (voltage itself does not hurt!). The more insensitive the animal is, the greater the energy needed to secure or scare it. The demand for pulse energy also increases with the length of the fence and its load (e.g. vegetation).



## Fence Resistance

as well as sufficient impulse energy, you also need highly conductive fence material to achieve the maximum shock possible and to make sure that there is minimum loss in the energy delivered to the animal, and no energy fade beforehand. The conductor resistance is a measure for assessing the fence material. It is specified in Ohm/meter. The smaller this value, the better the material conducts. The longer the fence, the better must be the conductivity of the chosen material. The best materials have a resistance <math>< 1 \Omega/m</math>; poorer materials exceed 4  $\Omega/m$ . Investigations have shown that, in addition to very good conductivity, which is achieved mostly by copper wire, long-term durability (e.g. by means of stainless steel wires with poor conductivity) is decisive for the security of an electric fence. Here, our proven TriCOND material provides the necessary compromise, and is renowned for outstanding conductivity combined with extended durability.



## What kilometre figures should you base your decision on?

Kilometre figures are often highly theoretical values that are based on the best possible conditions (wire conductivity, connections, insulation status, ground conditions, earthing) in the fence system. These conditions change constantly, however, due to the influences of weather. It is therefore important to achieve the minimum protective voltage of 2,500 (5000 Volt in the case of very robust animals and dry soils) at each point of the fence system in all conditions.

## How powerful does your fence device need to be?

This forms the basis for choosing the device family!

Select your fence length along the X-axis and your animal species or vegetation along the Y-axis.

You can see the minimum joule power required and the possible device families at the intersection.

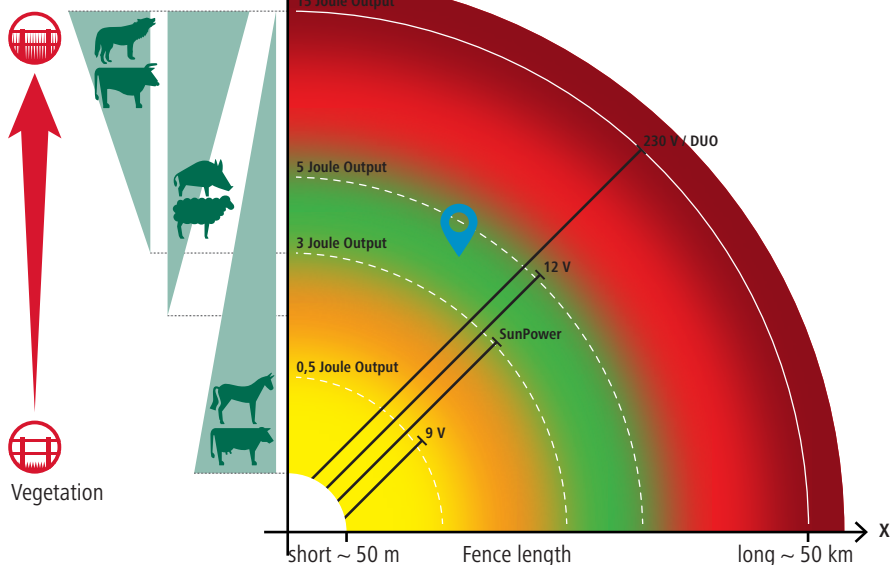
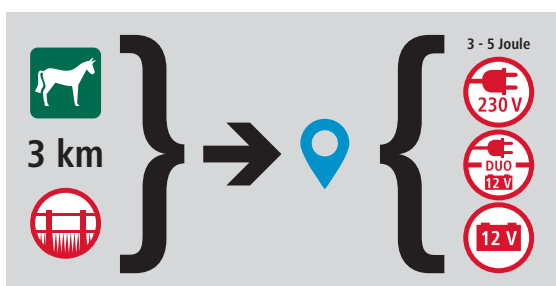

# Choosing your electric fence unit

max. 0,5 Joule



max. 3 Joule



max. 5 Joule



max. 15 Joule



## 230 V power energisers – the FIRST CHOICE if a mains socket is available.

These units have an unlimited protection period. They are available in all of the necessary power classes and are they best means of delivering the energy required (0.5 Joule up to 14.5 Joule output) on long fences or fences with vegetation, or for very robust animals. The higher energies of course do not harm the animals. All fence devices comply with applicable safety standards. If mobile use is intended, e.g. at tournaments, on trail or distance rides or simply on frequently changing pastures where there is no 230 Volt power supply available, you must resort to a battery-powered unit. For fences with heavier vegetative growth, 9 Volt compact solar units are inadequate and 12 Volt units must be used.



## 12 V battery units – strong performance even on fences with heavier vegetative growth.

12 V battery units are ideal for very robust animals, long fences and/or fences with vegetation if no 230 V connection is available. The discharge energy is comparable with mains devices (0.5 Joules to around 15 Joules output). Rechargeable 12 V wet batteries are used as the power source, which must be recharged every 2 – 4 weeks or so depending on the type of device, power requirements and battery type. Solar modules, which convert solar energy into electricity and therefore constantly top up the 12 V battery, are a good add-on.



## 12/230 V DUO units – maximum flexibility combined with powerful output energies!

Units of this type combine the unlimited security time of the 230 V units with the mobility of powerful 12 V units. A 12 V cable and 230 V adapter are included.



## 9 V dry battery units – the ideal units for smaller fences and paddocks!

9 V battery units are suitable for shorter fence lengths without vegetation. They are highly mobile and significantly lighter than 12 V units. The 9 V battery runs for a few months and can even cover an entire pasture season depending on the operating time, battery type and size (expressed in Ah – the more Ah (ampere hours), the longer it runs for). Once discharged, it cannot be recharged. 9 V units (even if these can also be operated with 12 V batteries) are weaker than 12 V units. 9 V units in this instance typically deliver approx. 0.15 to 0.35 joules. High-impact 9 V units can deliver up to 0.55 joules.



## Compact Solar Units

Compact solar units from the CLASSIC range – similar to 9 volt devices for smaller fences without vegetative growth, or: AKO SunPOWER from the PREMIUM and EXPERT range = extremely powerful, mobile compact solar units. Crystalline solar modules in combination with our high-performance solar fence devices are able to supply power to fences which are many kilometres in length. Even after a whole week without direct sunlight, these fence devices still have sufficient power to supply your fence with sufficient current. These special devices are outstandingly suited for fencing relatively large areas. Sufficient voltage is supplied everywhere along the fence, without the requirement for a socket anywhere nearby!



The 12-Volt AGM battery is integrated, and is constantly charged via the solar module built into the housing. If the battery has to be topped up, it can be recharged using the 230 volt mains adapter supplied.













### Expert tip:

the longer the fence, the more robust the animal or the thicker the vegetation, the more discharge energy in joules is required. If a socket is available, you should always use a 230-Volt device for the best protection!

# Explanation of symbols

Symbols	Short description	Unit	detailed description
	Grounding	Quantity	In order to enable electricity to flow freely from the ground to the device, optimal contact should be ensured between the earthing rod and soil (dry soil is a poor electricity conductor). The earthing rod (which must be galvanised) should therefore be driven into a damp area, or the length of the earthing rod should be measured to ensure that deeper, damper soil layers are reached. The recommended number of earthing rods depends on the power class of the device.
	Resistance	Ohms	The following resistance can be identified in a fence system: Earthing resistance => should be as low as possible Conductive material resistance => displayed in Ohm/metres. The smaller this value, the better the material's conductivity. The conductivity requirements of the material used increase with the length of the fence. The best materials have a resistance smaller than 0.25 Ω/m. Isolator resistance => should be as high as possible
	Max. Voltage	Volts	This voltage is reached with a low fence charge.
	Voltage in Open Circuit	Volts	Voltage when no fence system is connected to the electric fencer device.
	Voltage at 500 Ohms	Volts	Voltage at a fence load of 500 Ohms. This fence load represents, for example, a partially overgrown fence. The higher the voltage at a 500 Ohm fence load, the better these devices are suited to fences with vegetation. This fence load represents, for example, a partially overgrown fence. The higher the voltage at a 500 Ohm fence load, the better these devices are suited to fences with vegetation.
	Voltage at 100 Ohms	Volts	Voltage at a fence load of 100 Ohms. This fence load represents, for example, a heavily overgrown fence. The higher the voltage at a 100 Ohm fence load, the better these devices are suited to fences with thick vegetation.
	Stored Energy	Joules	Energy absorbed by device. The electric fencer efficiency ratio yields the relevant discharge energy value for the user.
	Max. Output	Joules	Maximum energy transmitted from the device to the fence system. This pulse is also identified as shock strength.
	Output Energy	Joules	Minimum energy transmitted from the device to the fence system. This can be reached through a fence output with reduced power or through selecting the lowest power level of an electric fencer device.
	Foal Protection Switch		Users can activate the foal protection switch as needed. If an animal should get caught in the fence, a considerably prolonged pulse interval (up to 60 sec.) does not excessively stress the animal and also increases the likelihood of it freeing itself. In parallel, the device emits an acoustic and visual alarm.

# Explanation of symbols

Symbols	Short description	Unit	detailed description
	Theor. Fence Length VDE (2000 V)	km	With fence lengths in accordance with VDE, only a theoretical value is given, which, as a result of various influences (fence flora, weather and soil conditions) cannot be reached in practice.
	Max. Fence Length with Varying Vegetative Growth	km	Flora on the fence has a considerable influence on the max. fence length for an electric fence device. The more vegetation on the fence, the higher the fence charge will be, thus reducing the max. fence length. The fence length indications refer to highly conductive wire material and connectors, good isolators and an optimal earthing system!
	Approx. Number of Electrifiable Nets	Quantity	For 230 V and 12 V devices, the maximum number of 50 m lines to be used is given.
	Voltage Supply 230 V	Volts	Devices with power supplies (230 V) have an unlimited protection duration. These are available in all necessary power classes and are the best solution for power provision to long fences. Even in the event of heavy vegetation, sufficient energy is supplied to the fence.
	Voltage Supply 12 V or 12 V Solar	Volts	12 Volt battery chargers are the ideal solution for long fences or fences with considerable amounts of vegetation in the event that no power supply is available. The discharge energy can be compared to the power supply units. Rechargeable 12 Volt wet cells are used as a source of power. A useful addition are solar modules, which are offered in a range of power classes and transform solar energy into electricity.
			
	Voltage Supply 230 V or 12 V	Volts	This type of device combines the unlimited protection duration of the 230 Volt devices with the mobility of the powerful 12 Volt devices.
	Voltage Supply 9 V	Volts	The 9 Volt dry battery devices are characterised by their excellent mobility, coupled with a long battery life. They are ideal for short fences with moderate vegetation if no power supply is available.
	Voltage Supply 2 x 1.5 V	Volts	3 Volt devices are mobile and easy to handle, and are suitable for fences without vegetation, such as in gardens or horse-training paddocks.
	Power Consumption	mA	The duration of the battery life can be calculated from the energy consumption along with the capacity of the battery.  Current consumption values are measured at 13 and 9 Volt and can rise as the battery voltage drops.
	Safety standard for devices from over 5 Joules to max. 15 Joules of discharge energy:		<ul style="list-style-type: none"> <li>delayed shock strength adjustment makes touching the fence safer for people and animals</li> <li>an alarm function continuously monitors the fence, triggering an alarm and slowing the pulse sequence if the fence is touched for a longer period</li> </ul>





5 year warranty on all fence devices!



We have sorted our range based on various criteria, to help you choose the right unit:

## Premium

- digital displays for easily reading all the important information about the unit and fence system (except solar units)
- powerful units for the most exacting requirements – long fence systems and difficult conditions are no problem
- intelligent adaptation to the fence status, and alarm functions ensure maximum safety for humans and animals
- the two smart solar devices S2400 and S4000 round off the premium device range



Digital display

## Expert

- LED displays allow easy visual monitoring of the current fence and unit status at a glance
- Units with a high output for demanding fences
- good equipment means high flexibility in use



LED display

## Classic

- Check lights for the unit or fence
- effective output, designed for standard fences
- low-cost entry-level units with solid equipment



Check light

## Extended warranty against theft









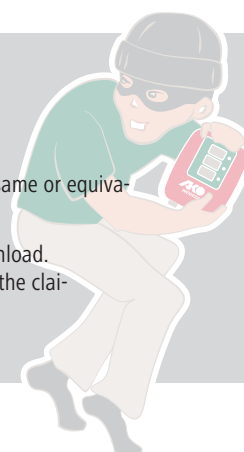





















With the extended warranty against theft, you can insure your new AKO electric fence device for three years against theft if operated in Germany, Austria or Italy.

In the event of theft, we will send you - following registration of the theft with the police - a new device of the same or equivalent type. In the case of 9-Volt battery devices, the extended warranty against theft also covers the dry battery.

The premium form for concluding an insurance policy can be found in the service section of our website to download. Please also refer to this document for the provisions regarding the legally valid conclusion of the insurance and the claiming of insurance benefits.



Ref. no.	Model	Page												
	372816	NDi 15000 smart	25	11,200 V	15 J	80 km	22 km	14 km	●	●	●	●	●	●
	372812	NDi 12000 smart	25	11,200 V	12 J	70 km	20 km	12 km	●	●	●	●	●	●
	372936	XDi 15000 smart	33	11,200 V	15 J	80 km	22 km	14 km	●	●	●	●	●	●
	372931	XDi 10000 smart	33	11,200 V	10 J	65 km	18 km	10 km	●	●	●	●	●	●
	372954	S 4000 smart	55	11,900 V	4 J	35 km	9 km	4 km	●	●	●	●	●	●
	372953	S 2400 smart	55	11,800 V	2.4 J	20 km	5 km	2 km	●	●	●	●	●	●
	372591	AD 5000 digital	41	11,000 V	4.6 J	38 km	14 km	5.5 km	●	●	●	●	●	●
	372291	AD 3000 digital	41	10,800 V	3 J	30 km	10 km	4 km	●	●	●	●	●	●
	372201	AD 2000 digital	41	10,500 V	2.1 J	20 km	8 km	3 km	●	●	●	●	●	●
	372036	BD 600 digital	69	11,700 V	0.55 J	10 km	7 km	2 km	●	●	●	●	●	●
	372034	BD 400 digital	69	11,400 V	0.4 J	8 km	5.5 km	1.7 km	●	●	●	●	●	●
	372814	Ni 14500	27	11,200 V	14.5 J	80 km	22 km	14 km	●	●	●	●	●	●
	372809	Ni 10500	27	11,200 V	10.5 J	65 km	18 km	10 km	●	●	●	●	●	●
	372801	Ni 6500	27	11,200 V	6.5 J	45 km	10 km	5 km	●	●	●	●	●	●
	372878	Xi 8000	35	11,200 V	8 J	50 km	17 km	7 km	●	●	●	●	●	●
	372879	Xi 8000 smart	35	11,200 V	8 J	50 km	17 km	7 km	●	●	●	●	●	●
	372876	X 6000 smart	35	12,000 V	5 J	40 km	11 km	6 km	●	●	●	●	●	●
	372868	X2 smart	37	11,800 V	2 J	15 km	3 km	1.6 km	●	●	●	●	●	●
	372869	X 1600 smart	37	11,000 V	1.6 J	12 km	2.5 km	1.5 km	●	●	●	●	●	●
	372955	S 3800	56	11,900 V	3.8 J	33 km	8 km	3.5 km	●	●	●	●	●	●
	372952	S 3000	56	11,900 V	3 J	30 km	6 km	3 km	●	●	●	●	●	●
	372951	S 1500	56	11,000 V	1.5 J	15 km	3 km	1.5 km	●	●	●	●	●	●
	372555	AN 6000	43	12,000 V	5 J	40 km	11 km	6 km	●	●	●	●	●	●
	372554	AN 4000	43	11,900 V	4 J	35 km	9 km	4 km	●	●	●	●	●	●
	372754	Savanne AM 3000	44	11,000 V	3 J	35 km	12 km	5 km	●	●	●	●	●	●
	372752	Savanne AM 2000	44	9,600 V	2 J	20 km	5 km	2 km	●	●	●	●	●	●
	372121	A 1200	45	10,700 V	1.4 J	10 km	5 km	1.5 km	●	●	●	●	●	●
	372030	B 500 plus	71	10,000 V	0.5 J	9 km	6 km	1.8 km	●	●	●	●	●	●
	372040	B 290	71	10,500 V	0.29 J	5 km	2 km		●	●	●	●	●	●
	372886	N 4800	29	9,000 V	4.8 J	30 km	8 km	4 km	●	●	●	●	●	●
	372883	N 3500	29	11,500 V	3.5 J	20 km	6 km	2.5 km	●	●	●	●	●	●
	372881	N 1200	29	12,500 V	1.2 J	10 km	2 km	1 km	●	●	●	●	●	●
	372080	N 700	75	8,800 V	0.55 J	7 km	1 km	0.3 km	●	●	●	●	●	●
	372874	X 4000	38	11,900 V	4 J	35 km	9 km	4 km	●	●	●	●	●	●
	372872	X 2500	38	11,800 V	2.5 J	18 km	4 km	1.7 km	●	●	●	●	●	●
	372871	X 1000	38	10,500 V	1 J	10 km	1.5 km	0.8 km	●	●	●	●	●	●
	372892	A 2000	47	9,600 V	2.5 J	25 km	5 km	2.5 km	●	●	●	●	●	●
	372055	AN 550	75	8,400 V	0.55 J	6 km	1 km	0.3 km	●	●	●	●	●	●
	372948	S 6	58	10,800 V	0.6 J	6 km	1.7 km	0.2 km	●	●	●	●	●	●
	372950	S 1000	59	11,000 V	1 J	10 km	2.5 km	1 km	●	●	●	●	●	●
	372949	S 500	59	10,800 V	0.55 J	6 km	1.7 km	0.2 km	●	●	●	●	●	●
	372920	S 250	60	10,500 V	0.25 J	3 km	0.7 km		●	●	●	●	●	●
	372026	B260 multi	73	9,800 V	0.26 J	4 km	1 km		●	●	●	●	●	●
	372018	B180	73	8,800 V	0.18 J	3 km	0.5 km		●	●	●	●	●	●
	372005	B 40	75	7,000 V	0.03 J	0.2 km			●	●	●	●	●	●



# Smart control

---

# You're in control!

Made in Germany



**up to date 24/7**

... constant monitoring via all smart devices



**FREE Kerbl Welt app**

... no follow-on costs at all for the functions provided by the app



**smart control via mobile phone or browser**

... Worldwide access to an unlimited number of smart devices in the app  
... unlimited number of users



**direct connection to the cloud/Internet**

... permanent, free mobile data transfer to the app



Download the app for free:





## Functions of the AKO Smart App



### Kerbl dashboard / device summary

The dashboard is where all the smart devices assigned to the account are managed. The „+“ allows you to add any number of new devices at any time.



### Operating status

Real-time notification in the event of a change of fence voltage (e.g. falls below alarm threshold)



### Data history

The app shows the fence and battery voltage fluctuations for up to a week in the background.



### Messages

Summary of all push notifications and power changes.



### Settings

User-defined options depending on the smart device type.



### Supply voltage

Current supply voltage in Volts.



### Reception quality

Displays the current wireless connection.



### Switching function

The smart fence device can be switched ON and OFF regardless of location.



### GPS tracking

The smart fence device can be localised.

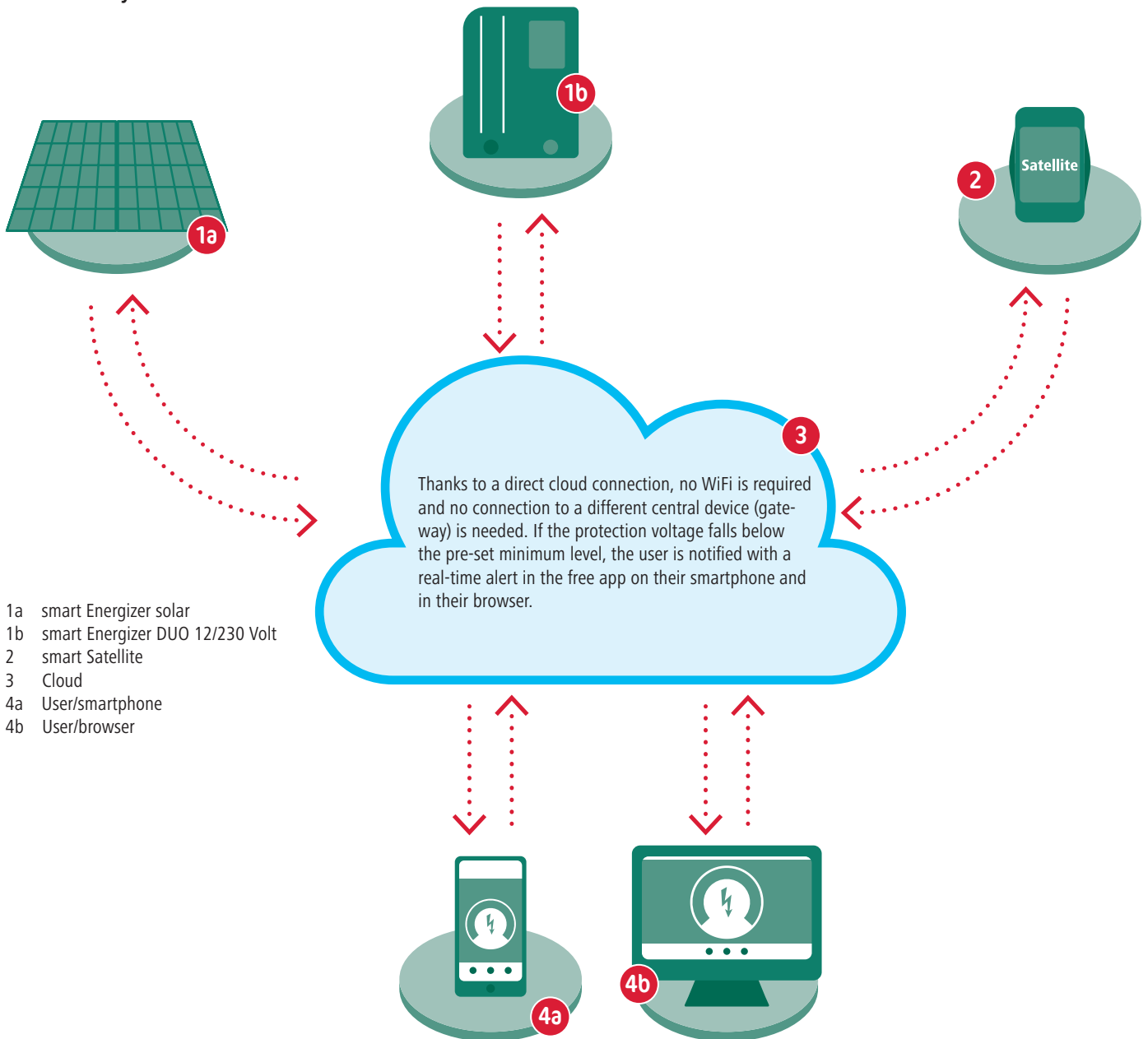

## Functional system of the AKO smart world!



- 1a smart Energizer solar
- 1b smart Energizer DUO 12/230 Volt
- 2 smart Satellite
- 3 Cloud
- 4a User/smartphone
- 4b User/browser

## App functions compared

### Fence device vs. Satellite

	SMART  ENERGIZER	 SmartSatellite2.0
Power supply	12 / 230 V	2 x 1.5 V
ON/OFF switching function	✓	✗
Power Regulation	✓	✗
Adjustable alarm threshold	✓	✓
up-to-date output voltage	✓	✓
up-to-date supply voltage	✓	✓
Alarm notifications	✓	✓
GPS Tracking	✓	✗
Data History	✓	✓
Mobile radio connection	LTE-M & NB-IoT	NB-IoT



# 230 Volt Power Supplies

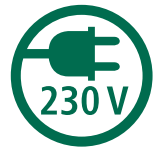

## AKO's power stations for the toughest fence requirements!

230 V power energisers provide security for an unlimited period. They are available in all the necessary power classes and are the best means of delivering the energy required (output 0.5 to 15 joules) on long fences or fences with vegetation, or for very robust animals. Animals and people are of course not harmed by this higher energy. All AKO units comply with applicable safety standards.

Made in Germany



## The advantages at a glance:

- Low energy costs
- Low maintenance
- High output
- Vegetation-resistant

## Recommended accessories:

(not included)



Underground cable,  $\varnothing$  1.6 mm item No. 44817, 44930, 44932, 44933

Connection cable (to earth / fence) NOT included in the scope of delivery!



Ground Rod with T-profile 1 m item no. 44615  
Ground Rod with T-profile 2 m item no. 441369



Lightning Choke item no. 44601



AKO Warning Sign item no. 446513



Digital Duo Voltmeter item No. 442328

# NDi smart

Made in Germany



5-year warranty



- AKO NDi devices automatically adapt to the fence status, ensuring maximum flock security and making your work easier by damaging vegetation to some degree
- delayed shock strength adjustment makes touching the fence safer for people and animals
- an alarm function continuously monitors the fence, triggering an alarm and slowing the pulse sequence if the fence is touched for a longer period
- robust, impact-resistant, UV and weather-resistant housing thanks to the use of high-quality plastics
- microprocessor controlled
- integrated hanging device for wall mounting
- fulfils applicable EU safety standards



Safety standard for devices from over 5 Joules to max. 15 Joules of discharge energy:

- delayed shock strength adjustment makes touching the fence safer for people and animals
- an alarm function continuously monitors the fence, triggering an alarm and slowing the pulse sequence if the fence is touched for a longer period



**Fence voltage high in kV (red knurled nut)**

The bar graph in the upper display area relates only to the high fence output

**Fence voltage low in kV (yellow knurled nut)**

**Smart reception quality**

**Ground voltage in kV**

Bar graph in the lower display area relates only to the ground voltage

**Fence output high**

Fence output for maximum device performance at the fence.

This „high“ output can be used simultaneously alongside the „low“ output for a separate fence.

**Fence output low**

Optional fence terminal for reduced device power (e.g. for small fence systems, paddocks, etc.).

This „low“ output can be used simultaneously, alongside the „high“ output, for a separate fence.

**I-0 switch**

I = ON  
0 = OFF

**Device earth connection**

min. 6 x 1 m ground rods  
or  
min. 3 x 2 m ground rods

# 230 Volt Power Supplies Premium



## AKO NDi 15000 smart

- smart Energiser - can be controlled via smartphone app and computer browser
- ultra-powerful 230 Volt power supply
- for long fences even with heavy vegetation
- especially for very robust animal species such as bulls, sheep, goats and for deterring wild boars and wolves
- 5-year warranty

## AKO NDi 12000 smart

- smart Energiser - can be controlled via smartphone app and computer browser
- extremely powerful 230 volt power supply
- for long fences even with heavy vegetation
- especially for robust animal species such as cattle, sheep, goats and for deterring wild boars and wolves
- 5-year warranty

### Smart fence device technology:

- constant control (24/7)
- free app download & no follow-on costs for the app, as well as mobile data transfer for the app
- Control via mobile phone or browser
- direct cloud connection (no WiFi required and no connection to a different central device, e.g. gateway, is needed)
- worldwide control (ON/OFF, GPS location) and monitoring of fence systems
- if the pre-set minimum protective voltage is not reached, the user is notified with a real-time alarm message



Digital display and multi-colour LED bar graph display

Digital display and multi-colour LED bar graph display



Ref. no.			€
372816	1	72	

Ref. no.			€
372812	1	72	

Model	Ref. no.														
NDi 12000 smart	372812	15.5 J	12 J	11,200 V	10,200 V	5,200 V	8,800 V	380 km	70 km	20 km	12 km	38	6	3	13.1 W
NDi 15000 smart	372816	20 J	15 J	11,200 V	10,200 V	5,300 V	8,800 V	450 km	80 km	22 km	14 km	40	6	3	16.4 W

# Ni

Made in Germany



- AKO Ni devices automatically adapt to the fence status, ensuring maximum flock security and making your work easier by damaging vegetation to some degree
- delayed shock strength adjustment makes touching the fence safer for people and animals
- an alarm function continuously monitors the fence, triggering an alarm and slowing the pulse sequence if the fence is touched for a longer period
- robust, impact-resistant, UV and weather-resistant housing thanks to the use of high-quality plastics
- microprocessor controlled
- integrated hanging device for wall mounting
- fulfils applicable EU safety standards

5-year warranty

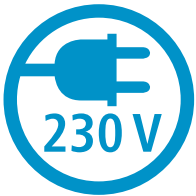

Safety standard for devices from over 5 Joules to max. 15 Joules of discharge energy:

- delayed shock strength adjustment makes touching the fence safer for people and animals
- an alarm function continuously monitors the fence, triggering an alarm and slowing the pulse sequence if the fence is touched for a longer period



Fence voltage high (red knurled nut)

Earth voltage

Fence output high

Fence output for maximum device performance at the fence. This „high“ output can be used simultaneously alongside the „low“ output for a separate fence.

Fence output low

Optional fence terminal for reduced device power (e.g. for small fence systems, paddocks, etc.).

This „low“ output can be used simultaneously, alongside the „high“ output, for a separate fence.

I-O switch

I = ON  
O = OFF

Device earth connection

min. 6 x 1 m ground rods  
or  
min. 3 x 2 m ground rods

# 230 Volt Power Supplies Expert

19,5 Joule



New product

NEW



14,0 Joule



New product

NEW



9,0 Joule



New product

NEW



## AKO Ni 14500

- ultra-powerful 230 Volt power supply
- for long fences even with heavy vegetation
- especially for very robust animal species such as horses, cattle, sheep, goats and for deterring wild boars and wolves
- 5-year warranty

## AKO Ni 10500

- extremely powerful 230 volt power supply
- for long fences even with heavy vegetation
- especially for very robust animal species such as horses, cattle, sheep, goats and for deterring wild boars and wolves
- 5-year warranty

## AKO Ni 6500

- extremely powerful 230 volt power supply
- for long fences even with medium to heavy vegetation
- especially for very robust animal species such as horses, cattle, sheep, goats and for deterring wild boars and wolves
- 5-year warranty

multi-colour LED bar graph display

multi-colour LED bar graph display

multi-colour LED bar graph display



Ref. no.			€
372814	1	72	



Ref. no.			€
372809	1	72	



Ref. no.			€
372801	1	72	

Model	Ref. no.														
Ni 6500	372801	9 J	6.5 J	11,200 V	10,200 V	4,900 V	8,800 V	200 km	45 km	10 km	5 km	20	6	3	6.9 W
Ni 10500	372809	14 J	10.5 J	11,200 V	10,200 V	5,100 V	8,800 V	320 km	65 km	18 km	10 km	35	6	3	10.9 W
Ni 14500	372814	19.5 J	14.5 J	11,200 V	10,200 V	5,300 V	8,800 V	440 km	80 km	22 km	14 km	40	6	3	16.4 W

# Power N

Made in Germany



- Our all-round devices for demanding applications.
- can be used with light to medium vegetative growth
  - robust, impact-resistant, UV-resistant and weather-resistant housing thanks to the use of high-quality plastics
  - microprocessor controlled
  - easy handling
  - integrated hanging device for wall mounting
  - very bright, clearly visible LED light
  - corresponds to applicable EU safety standards

5-year warranty



- N 1200:** Function indicator light
- N 3500:** combined fence voltage and earthing control
- N 4800:** multi-colour LED bar graph display for monitoring fence condition (i.e. fence wire insulation and device earthing are checked simultaneously)

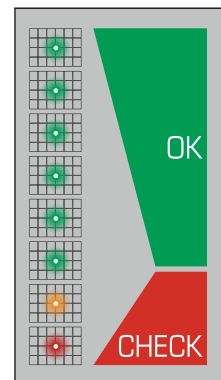

# 230 Volt Power Supplies Classic

6,7 Joule



5,5 Joule



1,7 Joule



## Power N 4800

- extremely powerful 230 volt power supply
- can be used with medium to heavy vegetative growth
- our all-round devices for more demanding applications - ideal for horses, cattle, sheep, goats and for keeping wild animals and wolves at bay
- 5-year warranty

## Power N 3500

- very effective 230 volt all-round power supply
- can be used with light to medium vegetative growth
- universally suitable for standard fences
- ideal for horses, cows, sheep, goats, chickens
- 5-year warranty

## Power N 1200

- effective 230 volt power supply
- for short fences and low vegetation
- ideal for small horse paddocks
- 5-year warranty

Multi-colour LED bar graph display for monitoring the fence/earthing status



Ref. no.			€
372886	1	121	

combined fence voltage and earthing control LED



Ref. no.			€
372883	1	88	

Function Indicator LED



Ref. no.			€
372881	1	88	

Model	Ref. no.													
N 1200	372881	1.7 J	1.2 J	12,500 V	9,000 V	3,400 V	40 km	10 km	2 km	1 km	5	1		5 W
N 3500	372883	5.5 J	3.5 J	11,500 V	10,000 V	5,700 V	90 km	20 km	6 km	2.5 km	14	2		7 W
N 4800	372886	6.7 J	4.8 J	9,000 V	8,600 V	5,700 V	130 km	30 km	8 km	4 km	18	2		7 W

## AKOtronic

Made in Germany



### AKOtronic S7K

- the cow trainer for shed use
- optical power control (LED flashes green with every pulse)
- with automatic switch off (device switches off after 5 short circuit pulses – LED then flashes red)
- 5-year warranty

5-year warranty

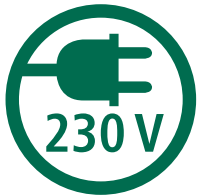

With time control: device pulses for 2 hours followed by a rest period of 5 hours. This sequence is constantly repeated.

0,13 Joule



Please note local animal welfare laws before use.



Ref. no.			€
350728	1	96	



# DUO Units (12 V / 230 V)

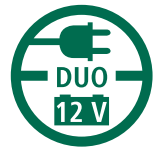

## DUO electric fence units 2 in 1

12/230 Volt DUO units – maximum flexibility combined with powerful output energies. Two power input options available – 230 Volt mains supply or 12 Volt battery. This means the unit can be used both for permanent fencing with a 230 V mains supply and for mobile fencing with a 12 V battery.

Made in Germany



## Recommended accessories:

(not included)



Ground Rod with round profile item no. 442380



AKO Warning Sign item no. 446513



Ground connection cable 3 m 44635/011



12 Volt, AGM battery  
Item No. 442067 75 Ah  
Item No. 441203 88 Ah  
Item No. 441204 110 Ah



Underground cable,  $\varnothing$  1.6 mm item No. 44817, 44930, 44932, 44933



Battery charger item No. 371037



Metal battery case item No. 44656, 44650



Digital Duo Voltmeter item No. 442328

## Power Pack All Weather DUO

- for connection to 230 V supply
- not suitable as a battery charger
- especially suitable for outdoor use
- not for XDi and smart devices



Ref. no.	Image	€
371024		1/60

# XDi smart

Made in Germany



5-year warranty



- AKO XDi devices automatically adapt to the fence status, ensuring maximum flock security and making your work easier by damaging vegetation to some degree
- Optimised energy consumption thanks to energy-saving mode – saves battery power for fences in good condition. Also intelligent battery management for when battery voltage decreases.
- robust, impact-resistant, UV and weather-resistant housing thanks to the use of high-quality plastics
- microprocessor controlled
- integrated hanging device for wall mounting
- fulfils applicable EU safety standards
- (suitable for metal box 44656 and 44650)
- Recommended solar module: 375999 (100 W), connection directly to the 12-Volt battery, optionally with ground anchor 442382 or fixing set 442386 for metal box



Safety standard for devices from over 5 Joules to max. 15 Joules of discharge energy:

- delayed shock strength adjustment makes touching the fence safer for people and animals
- an alarm function continuously monitors the fence, triggering an alarm and slowing the pulse sequence if the fence is touched for a longer period

## I-0-II switch

I = LOW/ECO mode  
0 = OFF  
II = HIGH/EXTREME mode

## 230 Volt connection

Mains adapter  
Item No. 371042

## 12 Volt connection

Connecting cable  
Item No. E268739

## Reference earth cable in conjunction with the supplied ground rod

Must be inserted into the soil separately!  
(min. 1 m distance for device grounding)

## Reference earth cable

Length: 175 cm  
Reference earth cable extension  
with item No. 44635/011 / 44636/011

## Device earth connection

min. 6 x 1 m ground rods  
or  
min. 3 x 2 m ground rods



## Fence voltage high in kV (red knurled nut)

The bar graph in the upper display area relates only to the high fence output

## Fence voltage low in kV (yellow knurled nut)

## Supply voltage in V

Battery symbol for visual check

## Ground voltage in kV

Bar graph in the lower display area relates only to the ground voltage

## Fence output low

Optional fence terminal for reduced device power (e.g. for small fence systems, paddocks, etc.).

This „low“ output can be used simultaneously, alongside the „high“ output, for a separate fence.

## Fence output high

Fence output for maximum device performance at the fence.

This „high“ output can be used simultaneously alongside the „low“ output for a separate fence.



## Power Station XDi 15000 smart

- smart Energiser - can be controlled via smartphone app and computer browser
- ultra powerful 12 / 230 Volt DUO unit
- for long fences even with heavy vegetation
- especially for very robust animals such as bulls, sheep and for keeping wild boar and wolves at bay
- 5-year warranty

recommended solar module: 375999 (100 W), connection directly to the 12-Volt battery, optionally with ground anchor 442386 or fixing set 442386 for metal box

## Power Station XDi 10000 smart

- smart Energiser - can be controlled via smartphone app and computer browser
- extremely powerful 12 / 230 Volt DUO unit
- for long fences even with heavy vegetation
- especially for robust animal species such as bulls, cattle, sheep and for deterring wild boars and wolves
- 5-year warranty

recommended solar module: 375999 (100 W), connection directly to the 12-Volt battery, optionally with ground anchor 442386 or fixing set 442386 for metal box

### Smart fence device technology:

- constant control (24/7)
- free app download & no follow-on costs for the app, as well as mobile data transfer for the app
- Control via mobile phone or browser
- direct cloud connection (no WiFi required and no connection to a different central device, e.g. gateway, is needed)
- worldwide control (ON/OFF, GPS location) and monitoring of fence systems
- if the pre-set minimum protective voltage is not reached, the user is notified with a real-time alarm message



Included in Delivery: 1 x fence unit, 1 x 230 volt power pack (371042), 1 x 12 Volt connection cable (E268739), 1 x ground connector cable, 1 x fence connector cable, 1 x reference connection cable, 1 x warning sign

Included in Delivery: 1 x fence unit, 1 x 230 volt power pack (371042), 1 x 12 Volt connection cable (E268739), 1 x ground connector cable, 1 x fence connector cable, 1 x reference connection cable, 1 x warning sign

Digital display and multi-colour bar graph display



Ref. no.			€
372936	1	72	

Digital display and multi-colour bar graph display



Ref. no.			€
372931	1	72	

Model	Ref. no.														
XDi 10000 smart	372931	15 J	10 J	11,200 V	10,200 V	5,100 V	8,800 V	320 km	65 km	18 km	10 km	35	6	3	410 - 770 mA
XDi 15000 smart	372936	20 J	15 J	11,200 V	10,200 V	5,300 V	8,800 V	450 km	80 km	22 km	14 km	40	6	3	410 - 1,160 mA

# Duo Power Xi & X

Made in Germany



5-year warranty



- AKO Xi and X devices automatically adapt to the fence status, ensuring maximum flock security and making your work easier by damaging vegetation to some degree
- Optimised energy consumption thanks to energy-saving mode – saves battery power for fences in good condition. Also intelligent battery management for when battery voltage decreases.
- robust, impact-resistant, UV and weather-resistant housing thanks to the use of high-quality plastics
- deep discharge protection for the 12 Volt battery
- solar backup possible
- microprocessor controlled
- integrated hanging device for wall mounting
- fulfils applicable EU safety standards
- (suitable for metal box 44656 and 44650)



Safety standard for devices from over 5 Joules to max. 15 Joules of discharge energy:

- delayed shock strength adjustment makes touching the fence safer for people and animals
- an alarm function continuously monitors the fence, triggering an alarm and slowing the pulse sequence if the fence is touched for a longer period



multi-colour LED bar graph display (10 LEDs) for monitoring the output voltage

Separate LED for battery warning (red)

High/low/off switch

Duo connection for 230 Volt operation or 12 Volt battery operation

Fence output

Earth

**Included in Delivery:** 1 x 12/230 Volt DUO Fence Device, 1 x 230 volt power pack (371030), 1 x 12 Volt connection cable (E268739), 1 x fence / ground connector cable, 1 x warning sign



## Duo Power Xi 8000

- extremely powerful 12/230 Volt DUO fence device for mobile or stationary use
- our all-round device – ideal for horses, bulls, sheep and for deterring wild boars and wolves
- can be used even with heavy vegetation
- 5-year warranty



## Duo Power Xi 8000 smart

- smart Energiser - can be controlled via smart-phone app and computer browser
- extremely powerful 12/230 Volt DUO fence device for mobile or stationary use
- can be used even with heavy vegetation
- our all-round device – ideal for horses, bulls, sheep and for deterring wild boars and wolves
- 5-year warranty

recommended solar module: 375999 (100 W), connection directly to the 12-Volt battery, optionally with ground anchor 442386 or fixing set 442386 for metal box



## Duo Power X 6000 smart

- smart Energiser - can be controlled via smart-phone app and computer browser
- 12/230 Volt DUO fence device – maximum flexibility combined with powerful output energy
- ideal for horses, cattle, sheep, goats and deterring wild boars and wolves
- can be used with medium to heavy vegetative growth
- 5-year warranty

recommended solar module: 375559 (55 Watt), connection directly to the 12-Volt battery, optionally with ground anchor 442382 or fixing set 442386 for metal box

### Smart fence device technology:

- constant control (24/7)
- free app download & no follow-on costs for the app, as well as mobile data transfer for the app
- Control via mobile phone or browser
- direct cloud connection (no WiFi required and no connection to a different central device, e.g. gateway, is needed)
- worldwide control (ON/OFF, GPS location) and monitoring of fence systems
- if the pre-set minimum protective voltage is not reached, the user is notified with a real-time alarm message



multi-colour LED bar graph display for output voltage and battery control

multi-colour LED bar graph display for output voltage and battery control

multi-colour LED bar graph display for output voltage and battery control



Ref. no.			€
372878	1	72	

Ref. no.			€
372879	1	72	

Ref. no.			€
372876	1	72	

Model	Ref. no.														
X 6000 smart	372876	7.5 J	5 J	12,000 V	10,000 V	3,600 V	9,000 V	130 km	40 km	11 km	6 km	20	2		140 - 380 mA
Xi 8000 smart	372879	12 J	8 J	11,200 V	10,200 V	4,500 V	8,700 V	240 km	50 km	17 km	7 km	30	6	3	165 - 570 mA
Xi 8000	372878	12 J	8 J	11,200 V	10,200 V	4,500 V	8,700 V	240 km	50 km	17 km	7 km	30	6	3	155 - 560 mA

# Duo Power X

Made in Germany



5-year warranty



- optimised power consumption thanks to energy-saving mode
- deep discharge protection with 12 V operation
- microprocessor controlled
- Plug Connector with Screw Fuse
- robust, impact-resistant, UV-resistant and weather-resistant housing thanks to the use of high-quality plastics
- integrated hanging device for wall mounting
- very bright, clearly visible LED light
- corresponds to applicable EU safety standards
- (suitable for metal box 44656 and 44650)



On/off switch  
(For Duo Power X4000, Duo Power X2500)

fence or function indicator LED and battery warning indicator

X 4000/X2/X1600:  
multi-colour LED bar graph display for output voltage and battery control

plug connector with screw fuse



**Included in Delivery:** 1 x fence unit, 1 x 230 volt power pack (371023), 1 x 12 Volt connection cable (E268739), 1 x ground connector cable, 1 x fence connector cable, 1 x warning sign (44623)



## AKO X2 smart

- smart Energiser - can be controlled via smartphone app and computer browser
- 12 / 230 Volt DUO unit with efficient output
- with High/Low/OFF switch for 2 different output powers
- for normal fences without vegetation
- 5-year warranty

recommended solar module: 375201 (20 Watt), connection directly to the 12-Volt battery, mounting e.g. on a metal box

## Duo Power X 1600 smart

- smart Energiser - can be controlled via smartphone app and computer browser
- 12 / 230 Volt DUO unit with efficient output
- with High/Low/OFF switch for 2 different output powers
- for normal fences without vegetation
- 5-year warranty

recommended solar module: 375201 (20 Watt), connection directly to the 12-Volt battery, mounting e.g. on a metal box

### Smart fence device technology:

- constant control (24/7)
- free app download & no follow-on costs for the app, as well as mobile data transfer for the app
- Control via mobile phone or browser
- direct cloud connection (no WiFi required and no connection to a different central device, e.g. gateway, is needed)
- worldwide control (ON/OFF, GPS location) and monitoring of fence systems
- if the pre-set minimum protective voltage is not reached, the user is notified with a real-time alarm message



multi-colour LED bar graph display for output voltage and battery control

multi-colour LED bar graph display for output voltage and battery control



Ref. no.			€
372868	1	88	

Ref. no.			€
372869	1	88	

Model	Ref. no.												
X2 smart	372868	2.8 J	2 J	11,800 V	10,000 V	7,300 V	60 km	15 km	3 km	1.6 km	8	2	68 - 159 mA
X 1600 smart	372869	2.2 J	1.6 J	11,000 V	10,000 V	6,900 V	45 km	12 km	2.5 km	1.5 km	6	2	58 - 113 mA

# DUO Units Classic

5,5 Joule



3,2 Joule



**Top Seller**



1,6 Joule



## Duo Power X 4000

- 12 V / 230 V DUO device with extremely high output power
- for longer fences, also with vegetation
- ideal for use also with strong animals and for keeping wild boar and wolves at bay
- with High/Low/OFF switch for 2 different output powers
- 5-year warranty

## Duo Power X 2500

- 12 V / 230 V DUO unit with high output
- for normal fence systems with low vegetation
- with on/off switch
- 5-year warranty

recommended solar module: item number

## Duo Power X 1000

- 12 V / 230 V DUO unit with effective output power
- for short fences without vegetation
- 5-year warranty

recommended solar module:  
Item number. 375301 (30 Watt),  
connection directly to the 12-Volt  
battery, mounting e.g. on a metal  
box or: Item number 375559  
(55 Watt), connection directly to  
the 12-Volt battery plus ground  
anchor kit 442382 or fixing set  
442386 for metal box



375301 (30 Watt), connection  
directly to the 12-Volt battery,  
mounting e.g. on a metal box



recommended solar  
module: 375201 (20 Watt),  
connection directly to the  
12-Volt battery, mounting  
e.g. on a metal box



multi-colour LED bar graph display for  
output voltage and battery control

multi-colour LED bar graph display for  
output voltage and battery control

function control LED and visual  
battery warning indicator



Ref. no. €  
372874 1 88

Ref. no. €  
372872 1 88

Ref. no. €  
372871 1 88

Model	Ref. no.													
X 1000	372871	1.6 J	1 J	10,500 V	9,000 V		4,400 V	35 km	10 km	1.5 km	0.8 km	4	1	115 mA
X 2500	372872	3.2 J	2.5 J	11,800 V	10,300 V		7,400 V	70 km	18 km	4 km	1.7 km	10	2	56 - 175 mA
X 4000	372874	5.5 J	4 J	11,900 V	10,300 V	3,500 V	8,400 V	110 km	35 km	9 km	4 km	16	2	117 - 300 mA

# 12 V Battery Units



solar modules optionally available

## Strong output even on fences with heavier vegetation!

12 V battery units are ideal for very robust animals, long fences and/or fences with vegetation if no 230 V connection is available. The discharge energy is comparable to that of power energisers (output approx. 0.5 to 5 joules). Rechargeable 12 V batteries are used as the power source, and must be recharged every 2 – 4 weeks or so depending on the type of unit, required power and battery type. Solar modules, which convert solar energy into electricity and therefore constantly top up the 12 V battery, are a good add-on. All our 12 V units have deep discharge protection, helping you maintain the performance of the 12 batteries.

Made in Germany



## The advantages at a glance:

- Mobile
- Powerful
- Rechargeable
- Solar option
- Deep discharge protection

## Recommended accessories:

(not included)



Ground Rod with round profile item no. 442380



Ground connection cable 3 m 44635/011



12 Volt, AGM battery  
Item No. 442067 75 Ah  
Item No. 441203 88 Ah  
Item No. 441204 110 Ah



Metal battery case item No. 44656, 44650



Underground cable, ø 1.6 mm item No. 44817, 44930, 44932, 44933



AKO Warning Sign item no. 446513



Digital Duo Voltmeter item No. 442328

## 230 Volt Power Pack

- for connection to a 230 Volt supply (can therefore be operated both with or without 12 Volt battery)

for AD 2000 digital, AD 3000 digital, AD 5000, A 1200



Not suitable as a battery charger for large 12 Volt batteries (over 30 Ah).

Ref. no.		€
371012	1/80	

# Mobil Power AD

Made in Germany



5-year warranty



- with 12 Volt full discharge protection
- the shock strength can be steplessly adjusted with the manual controller (1 - 20)
- can be operated via a 230-V power pack (371012 - not included)
- integrated solar charge controller
- digital display to indicate the fence voltage, battery voltage and power level
- robust, impact-resistant, UV-resistant and weather-resistant housing thanks to the use of high-quality plastics
- large battery container for the 12-Volt battery
- microprocessor controlled
- very bright, clearly visible LED light
- corresponds to applicable EU safety standards



**Variable output control:**  
Normal field operation 1 – 15  
Extreme conditions 16 – 20



**Battery voltage:** Displays the current battery voltage in V. The 12 V battery should be connected to 12 V minimum – and ideally over 12.5 V.



**Fence output voltage:** Display of the output voltage in kV. Enables even the smallest changes to fence status to be detected.



Recommended 12 V battery: 88 Ah AGM, item No. 441203 (max. L x W x H 281 x 184 x 225 mm)

**Included:**  
1 x fence device,  
1 x fence / ground connection cable,  
1 x warning sign,  
1 x 12 Volt connection cable (item No. E263616 available separately for AD 2000 digital and AD 3000 digital)  
1 x 9 Volt connection cable (item No. E263617 available separately for AD 2000 digital and AD 3000 digital)

# 12 Volt Battery Units Premium

7,4 Joule



5,7 Joule



3,0 Joule



## Mobil Power AD 5000 digital

- ultra high-capacity 12 volt battery unit for mobile, extreme applications and heavy vegetative growth
- not suitable for 9 Volt operation.
- 5-year warranty

recommended solar module: 375559 (55 W), connection directly to the 12-Volt battery - ideal with ground anchor kit 442382



... can also be used to ward off game and wolves!

digital display readout and LED lights for fence and battery voltage



Ref. no.			€
372591	1	33	

## Mobil Power AD 3000 digital

- extremely effective 12 volt power supply for mobile and extreme usage
- allows for alternative operation with 9 Volt dry battery
- 5-year warranty

recommended solar module: Item number 375306 (30 Watt) - mounting directly on the device handle

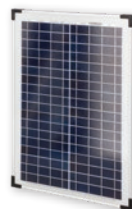

... can also be used to ward off game and wolves!

digital display readout and LED lights for fence and battery voltage



Ref. no.			€
372291	1	33	

## Mobil Power AD 2000 digital

- extremely powerful 12 Volt battery unit for mobile use, long fences with vegetation and powerful animals
- allows for alternative operation with 9 Volt dry battery
- 5-year warranty

recommended solar module: Item number 375206 (20 Watt) - mounting directly on the device handle



digital display readout and LED lights for fence and battery voltage



Ref. no.			€
372201	1	33	

Model	Ref. no.													
AD 2000 digital	372201	3 J	2.1 J	0.5 J	10,500 V	9,600 V	5,200 V	55 km	20 km	8 km	3 km	8	2	17 - 220 mA
AD 3000 digital	372291	5.7 J	3 J	0.5 J	10,800 V	9,800 V	6,000 V	90 km	30 km	10 km	4 km	12	2	17 - 290 mA
AD 5000 digital	372591	7.4 J	4.6 J	1 J	11,000 V	10,000 V	6,500 V	115 km	38 km	14 km	5.5 km	18	5	100 - 460 mA

# Mobil Power AN

Made in Germany



5-year warranty



- extremely powerful fence device for 12-Volt battery operation
- All-round devices for demanding, mobile use
- multi-colour LED bar graph display for monitoring the output voltage
- separate LED for battery warning (red)
- optimised consumption thanks to energy saving mode – saves battery power in fences in good condition. Also intelligent battery management for when battery voltage decreases.
- deep discharge protection for the 12 volt battery
- microprocessor controlled
- solar backup possible
- can be operated via a 230-V power pack (371023 - not included)
- robust, impact-resistant, UV-resistant and weather-resistant housing thanks to the use of high-quality plastics
- integrated hanging device for wall mounting
- very bright, clearly visible LED light
- corresponds to applicable EU safety standards
- (suitable for metal box 44656 and 44650)



- multi-colour LED bar graph display (10 LEDs) for monitoring the output voltage
- Separate LED for battery warning (red)
- connection socket for back-up operation\* (optional) and solar connection AN 4000  
\* The unit is normally connected to a 12-Volt battery at the bottom screw cap and at the same time to the 230-Volt mains adapter (371012 - not included) at the top socket. If the 230-Volt mains supply fails, the unit automatically switches to 12-Volt operation.
- High/low/off switch
- connection for 12-Volt battery operation or optionally for 230-Volt operation (371023)
- Fence output
- Earth

Included in Delivery: 1 x fence unit, 1 x fence / ground connector cable, 1 x 12 Volt connection cable (E268739), 1 x warning sign

Recommended 12 V battery: 110 Ah AGM, item no. 441204

# 12 Volt Battery Unit Expert

7,0 Joule



5,5 Joule



## Mobil Power AN 6000

- extremely powerful 12 Volt fence device for demanding mobile use
- can be used with medium to heavy vegetative growth
- our all-round device for more demanding mobile or static applications - ideal for horses, cattle, sheep and deterring wild boars and wolves
- 5-year warranty

recommended solar module: 375559 (55 Watt), connection directly to the 12-Volt battery, optionally with ground anchor 442382 or fixing set 442386

for metal box



multi-colour LED bar graph display for output voltage and battery control



Ref. no.			€
372555	1	72	

## Mobil Power AN 4000

- very powerful fence device for 12 volt battery operation
- can be used with light to medium vegetative growth
- our all-round device for demanding applications - ideal for horses, cattle, sheep, goat and deterring wild animals
- 5-year warranty

recommended solar module: 375306 (30 Watt), for direct connection to the device and for attachment to the metal box



multi-colour LED bar graph display for output voltage and battery control



Ref. no.			€
372554	1	72	

Model	Ref. no.													
AN 4000	372554	5.5 J	4 J	11,900 V	10,300 V	3,500 V	8,400 V	110 km	35 km	9 km	4 km	16	2	117 - 300 mA
AN 6000	372555	7.5 J	5 J	12,000 V	10,000 V	3,600 V	9,000 V	130 km	40 km	11 km	6 km	20	2	130 - 370 mA

# 12 Volt Battery Unit Expert



**Top Seller**

4,5 Joule



5-year warranty



## Savanne AM 3000

includes metal box

- 12 volt rechargeable battery device with extremely high power output
- for long fence systems with heavy vegetative growth
- also available as a starter set
- with on/off switch
- 5-year warranty

recommended solar module: item number 375301 (30 Watt), connection directly to the 12-Volt battery, mounting e.g. on a metal box



Included in Delivery: 1 x fence device incl. 12 Volt connection cable and metal box, 1 x fence / ground connector cable, 1 x warning sign

fence control LED and separate battery warning indicator



Ref. no.			€
372754	1	27	

3,2 Joule



5-year warranty



## Savanne AM 2000

includes metal box

- 12 volt device with high output power for normal fencing systems, even with heavier vegetative growth
- with on/off switch
- 5-year warranty

recommended solar module: item number 375301 (30 Watt), connection directly to the 12-Volt battery, mounting e.g. on a metal box



Included in Delivery: 1 x fence device incl. 12 Volt connection cable and metal box, 1 x fence / ground connector cable, 1 x warning sign

fence control LED and separate battery warning indicator



Ref. no.			€
372752	1	27	



with on/off switch

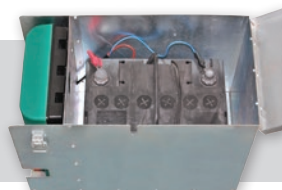

Internal dimensions approx. 295 x 200 x 250 mm, suitable for batteries with max. 100 Ah (battery not included in scope of supply)

Model	Ref. no.												
Savanne AM 2000	372752	3.2 J	2 J	9,600 V	8,300 V	6,100 V	60 km	20 km	5 km	2 km	8	2	75 - 193 mA
Savanne AM 3000	372754	4.5 J	3 J	11,000 V	10,300 V	7,600 V	95 km	35 km	12 km	5 km	12	2	59 - 220 mA

# 12 Volt Battery Unit Expert



2,1 Joule



5-year warranty



## Mobil Power A 1200

- universal, very effective 12 volt battery unit for mobile use
- two separate LEDs for fence voltage and battery control
- manual turn switch (1 – 10) adjusts output energy steplessly – this makes power input adjustable to adapt more efficiently to fencing conditions
- can be operated via a 230-V power pack (371012 - not included)
- allows for alternative operation with 9 Volt dry battery
- 5-year warranty

recommended solar module: item no. 375206 (20 watts)



Ref. no.			€
372121	1	33	

- normal field operation: level 1 - 7
- extreme operation: level 8 - 10
- On/Off



Model	Ref. no.													
A 1200	372121	2.1 J	1.4 J	0.48 J	10,700 V	9,000 V	4,400 V	40 km	10 km	5 km	1.5 km	5	1	15 - 150 mA

# Power A

Made in Germany



5-year warranty



Our 12 Volt Classic device is cheap and offers simplified functions for all standard fences with normal vegetation.

- with 12 Volt full discharge protection
- crocodile clips made of high-quality stainless steel
- low energy consumption thanks to energy-saving mode
- robust, impact-resistant, UV-resistant and weather-resistant housing thanks to the use of high-quality plastics
- integrated hanging device for wall mounting
- very bright, clearly visible LED light
- corresponds to applicable EU safety standards



On/off switch

Fence voltage control

Battery voltage control  
(red LED flashes when battery reaches 40 % of its remaining capacity)

## Included:



Ground connection cable



Fence connecting wire



Warning Sign (44623)

# 12 Volt Battery Unit Classic



## Power A 2000

- efficient 12 volt battery unit for mobile use
- ideal for horse and cattle fences
- with on/off switch
- solar backup possible
- 5-year warranty

recommended solar module: item no. 375201 (20 watts) – for connecting directly to the 12 volt battery



fence control LED and separate battery warning indicator



Ref. no.			€
372892	1	88	

Model	Ref. no.												
A 2000	372892	3.5 J	2.5 J	9,600 V	9,600 V	7,200 V	85 km	25 km	5 km	2.5 km	10	2	90 - 220 mA

# Starter Set for Fences

Complete set up to 20 % cheaper than buying the parts individually!

These sets include AKO products for your fence, perfectly matched by experts. This guarantees perfect operation right from the start when connected to your fence. And your wallet will be happy, because you will save a lot of money compared to buying the products individually!



## Starter Kit Mobil Power AD 3000 digital

- mobile starter kit with extremely powerful 12 V battery unit
- all components perfectly harmonised
- flexible power supply
- precise control and digital status display
- robust and weather-resistant for outdoor use
- Joule input: 5.7 J

Set consisting of: 1 x Mobil Power AD digital fence unit, 1 x AGM battery 12 Volt, 88 Ah, 3 x ground rod mobile, 2 x ground cable 3 m



Ref. no.	Description		€
441112	no solar module	1	
441113	incl. 30 Watt solar module	1	



## Starter Kit Mobil Power AN 6000

- Complete set with 88 Ah AGM battery, 3 mobile ground rods and connection cables - ready for immediate use
- robust, weatherproof metal box for mobile outdoor use
- ideally matched components
- flexible power supply - mains-independent with rechargeable battery, optionally extendable with 55-Watt solar module incl. charge controller
- powerful 12 V unit with 7.5 J input energy, optional operation via 230 V power pack possible (371023 not included in scope of delivery)

Set consisting of: 1 x Mobil Power AN fence unit, 1 x AGM battery 12 Volt, 88 Ah, 1 x battery box (44656), 3 x ground rod mobile, 2 x ground cable 3 m



Ref. no.	Description		€
441136	no solar module	1	
441137	incl. 55 Watt solar module, solar charge controller and metal box mounting kit (442386)	1	

## Starter Kit Savanne AM 3000

- powerful 12 Volt fence device with high pulse energy provides reliable protection for large areas - perfect for horses, cattle, sheep & protection from wild animals
- powerful 88 Ah battery guarantees reliable operation even in remote locations - with optional solar panel for even more independence
- Complete set with all accessories for quick and easy assembly - ideal for mobile pastures and seasonal use without much effort
- clear LED displays make monitoring child's play, deep discharge protection with optional solar module reliably protects the battery - for carefree use every day
- weatherproof metal box reliably protects the device from wind and weather - robustly built for long-term use in all conditions

Set consisting of: 1 x Savanne AM 3000 fence device, 1 x AGM battery 12 Volt, 88 Ah, 3 x ground rod mobile, 2 x ground cable 3 m



Ref. no.	Description		€
441120	no solar module	1	
441121	incl. 30 Watt solar module and solar charge controller	1	





## Use the natural power of the sun!

AKO SunPOWER = extremely powerful, mobile compact solar units. Crystalline solar modules in combination with our high-performance solar fence devices are able to supply power to fences which are many kilometres in length. Even after a whole week without direct sunlight, these fence devices still have sufficient power to supply your fence with sufficient current. These special devices are outstandingly suited for fencing relatively large areas. Sufficient voltage is supplied everywhere along the fence, without the requirement for a socket anywhere nearby!

Made in Germany



## Solar electricity – environmentally-friendly, cost-effective energy!

- No maintenance or follow-up costs.
- Maintenance-free operation from spring to autumn

Tip: Charge the battery during longer breaks in operation (such as winter). solar fence device is switched off

1. Disconnect the 12 volt battery from the solar fence device and only reconnect it for commissioning after storing it.
2. Connect the 230 volt mains charger to the red (+) and black (-) terminals on the 12 volt battery.
3. Now plug the adapter into the socket and charge as follows:

- a) ... at least 1 day before storage
- b) ... at least every 3 months during breaks in operation
- c) ... at least 1 day before commissioning
- d) storage temperature: frost-free up to 20 degrees

IMPORTANT: 230-Volt mains charger can also remain permanently connected to the battery during the entire storage period.

## Recommended accessories:

(not included)



Spiral ground/retaining anchor  
item No. 442383 (for S 4000, S 3800, S 3000, S 2400 smart, S 1500)



Wooden post mount stainless steel, incl. wood screws item No. 442384 (for S 4000, S 3800, S 3000, S 2400 smart, S 1500)



T-Post installation



Ground Rod with T-profile 1 m item no. 44615

Ground Rod with T-profile 2 m item no. 441369



## Solar power stations

... available in various versions!

- suitable for mobile use
- ideal for long fence systems without 230 Volt access
- autonomous operation during the grazing season from April to October

Scope of delivery of all stations:

- Solar module
- 12 Volt battery with charge controller
- Ground spikes
- Earth/fence connection cable
- Electrifiable connection option
- weather-resistant HPL panel cladding
- fully assembled on a plastic pallet

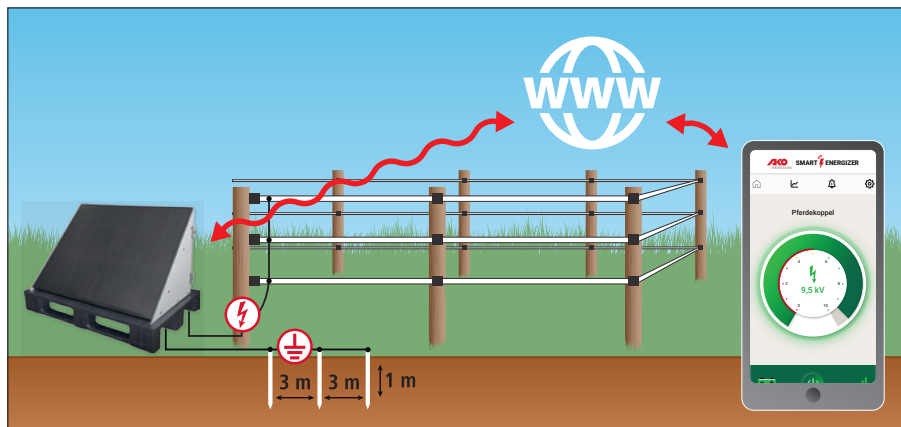

### Smart fence device technology:

- constant control (24/7)
- free app download & no follow-on costs for the app, as well as mobile data transfer for the app
- Control via mobile phone or browser
- direct cloud connection (no WiFi required and no connection to a different central device, e.g. gateway, is needed)
- worldwide control (ON/OFF, GPS location) and monitoring of fence systems
- if the pre-set minimum protective voltage is not reached, the user is notified with a real-time alarm message





## Solar Station XL & XXL

- Smart Energizer - can be controlled via smartphone app and browser
- ideal for robust animal species such as horses, bulls, sheep, goats and for deterring wild boars and wolves



**250  
Watt  
Solar**

### AKO Solar Station XXL smart

- ultra-high-impact solar station
- for very long fences even with heavy vegetation
- 5-year warranty (device & solar module), 6-month warranty (12 Volt battery)
- fully assembled on a plastic pallet (120 x 80 cm)

### AKO Solar Station XL smart

- extremely high-impact solar station
- for long fences even with heavy vegetation
- 5-year warranty (device & solar module), 6-month warranty (12 Volt battery)
- fully assembled on a plastic pallet (120 x 80 cm)

## Solar Station L

- available with a smart or non-smart fence device
- ideal for robust animal species such as horses, cattle, sheep, goats and for deterring wild boars and wolves

New product

NEW



**100  
Watt  
Solar**

### AKO Solar Station L smart

- extremely high-impact solar station
- for fences with moderate to heavy vegetation
- 5-year warranty (device & solar module), 6-month warranty (12 Volt battery)
- fully assembled on a plastic pallet (80 x 60 cm)

### AKO Solar Station L

- extremely high-impact solar station
- for fences with moderate to heavy vegetation
- 5-year warranty (device & solar module), 6-month warranty (12 Volt battery)
- fully assembled on a plastic pallet (80 x 60 cm)

	Ref. no.	Description		€
Solar Station L	441090	incl. AKO X 5000 (7.5 input Joules) and 1 x 88 Ah battery	1	NEW
Solar Station L smart	441091	incl. AKO X 5000 smart (7.5 input Joules) and 1 x 88 Ah battery	1	NEW
Solar Station XL smart	441101	incl. AKO Xi 8000 smart (12.0 input Joules) and 1 x 110 Ah battery	1	
Solar Station XXL smart	441103	incl. AKO XD1 15000 smart (20.0 input Joules) and 2 x 110 Ah batteries	1	
Solar Station XL	441101-0	without fence device, incl. 1 x 110 Ah battery	1	
Solar Station XXL	441103-0	without fence device, incl. 2 x 110 Ah battery	1	

Model	Ref. no.												
L	441090	7.5 J	5 J	12,000 V	10,000 V	9,000 V	130 km	40 km	11 km	6 km	20	2	130 - 370 mA
L smart	441091	7.5 J	5 J	12,000 V	10,000 V	9,000 V	130 km	40 km	11 km	6 km	20	2	140 - 380 mA
XL smart	441101	12 J	8 J	11,200 V	10,200 V	8,700 V	240 km	50 km	17 km	7 km	30	6	165 - 570 mA
XXL smart	441103	20 J	15 J	11,200 V	10,200 V	8,900 V	350 km	80 km	22 km	14 km	40	6	410 - 1,170 mA

# Sun Power S

Made in Germany



5-year warranty



- optimised for permanent, maintenance-free operation right through the main pasture season
- with High/Low/Off switch
- integrated lightning protection
- intelligent, modern battery management with deep discharge protection – device functions even during extended periods of bad weather
- excellent level of efficiency – therefore a longer battery life
- very robust, weather-resistant, water-tight casing with carrying handle
- fast and easy to install
- power saving switch for when battery voltage fails
- additional power saving function when the fence status is good
- microprocessor controlled
- very bright, clearly visible LED light
- corresponds to applicable EU safety standards
- Functions: Herding the animals during the run
- directly integrated cloud connection
- distance-neutral control (ON/OFF, GPS tracking) and monitoring of fence systems
- permanently free mobile data transfer to the app
- if the protection voltage falls below the pre-set minimum level, the user is notified with a real-time alert in the free app on their smartphone



Tip for longer-term storage (e.g. in winter):

A: Switch the device off

B: Connect the 230 Volt mains charger to the charging socket on the side of the device housing and use it to charge the 12 Volt battery for at least 24 hours

a) ... prior to storage

b) ... at least every 3 months during breaks in operation

c) ... before commissioning

Storage temperature: frost-free up to 20 degrees

IMPORTANT: The 230 Volt mains charger can remain permanently connected to the battery or the charging socket throughout the entire storage period.



Important: you must use several additional ground rods if the ground is dry (e.g. item no. 44615)

**Scope of delivery S 4000 smart, S 24000 smart:** 1 x solar fence device\*, 1 x AGM battery 12 Volt / 18 Ah (441125), 1 x crystalline solar module\* 12 Volt (S 4000 smart: 40 Watt (E262640); S 2400 smart: 30 Watt (E262630)), unassembled, 1 x 230 Volt power pack (371012), 1 x fence connection cable, 1 x ground connection cable, 1 x two-piece earth/mounting spike (442385), 1 x warning sign

\* 5-year warranty (device & solar module) \* 6-month warranty (12 Volt battery)

# Solar Units Premium



Sun Power S 4000 smart

Sun Power S 2400 smart



Smart fence device technology:

- constant control (24/7)
- free app download & no follow-on costs for the app, as well as mobile data transfer for the app
- Control via mobile phone or browser
- direct cloud connection (no WiFi required and no connection to a different central device, e.g. gateway, is needed)
- worldwide control (ON/OFF, GPS location) and monitoring of fence systems
- if the pre-set minimum protective voltage is not reached, the user is notified with a real-time alarm message



multi-coloured LED bar graph display for output voltage and battery control plus solar operation LED (blue)

multi-coloured LED bar graph display for output voltage and battery control plus solar operation LED (blue)



Ref. no.			€
372954	1	24	

Ref. no.			€
372953	1	24	

Model	Ref. no.													
S 2400 smart	372953	3.2 J	2.4 J	11,800 V	10,300 V		7,400 V	72 km	20 km	5 km	2 km	10	2	56 - 176 mA
S 4000 smart	372954	5.5 J	4 J	11,900 V	10,300 V	3,500 V	8,400 V	110 km	35 km	9 km	4 km	16	2	120 - 300 mA



## Sun Power S 3800



## Sun Power S 3000



## Sun Power S 1500

Included in Delivery: 1 x solar fence device\*, 1 x AGM battery, 12 volt, 18 Ah (441125)\*, 1 x 12-Volt crystalline solar module, 40 Watt (not assembled)\*, 1 x 230 volt battery mains charger (371012), 1 x fence connector cable, 1 x ground connector cable, 1 x two-part ground/installation spear (442385), 1 x warning sign, \* Warranty: solar fence device (5 year warranty), solar module (5 year performance warranty), 12 volt battery (6 month warranty)

Included in Delivery: 1 x solar fence device\*, 1 x AGM battery, 12 volt, 18 Ah (441125)\*, 1 x 12-Volt crystalline solar module, 30 Watt (not assembled)\*, 1 x 230 Volt battery mains charger (371012 from model year 06/2024, before 371032), 1 x fence connector cable, 1 x ground connector cable, 1 x two-part ground/installation spear (442385), 1 x warning sign, \* Warranty: solar fence device (5 year warranty), solar module (5 year performance warranty), 12 volt battery (6 month warranty)

Included in Delivery: 1 x solar fence device\*, 1 x AGM battery, 12 volt, 18 Ah (441125)\*, 1 x 12 Volt crystalline solar module, 20 Watt (E282120) (not assembled)\*, 1 x 230 volt battery mains charger (371012 from model year 2024, before 371032), 1 x fence connector cable, 1 x ground connector cable, 1 x two-part ground/installation spear (442385), 1 x warning sign, \* Warranty: solar fence device (5 year warranty), solar module (5 year performance warranty), 12 volt battery (6 month warranty)

multi-coloured LED bar graph display for output voltage and battery control plus solar operation LED (blue)



Ref. no.			€
372955	1	24	

multi-coloured LED bar graph display for output voltage and battery control plus solar operation LED (blue)



Ref. no.			€
372952	1	24	

Fence control LED and visual battery warning indicator plus solar operation LED (blue)



Ref. no.			€
372951	1	24	

## Spare Battery

Ref. no.	Voltage	Capacity		€
441125	12 V	18 Ah	1/2	

Model	Ref. no.													
S 1500	372951	2.3 J	1.5 J	11,000 V	10,000 V		5,400 V	45 km	15 km	3 km	1.5 km	6	1	77 - 121 mA
S 3000	372952	4.2 J	3 J	11,900 V	10,200 V		7,600 V	95 km	30 km	6 km	3 km	12	2	59 - 220 mA
S 3800	372955	5.3 J	3.8 J	11,900 V	10,200 V	3,400 V	8,300 V	100 km	33 km	8 km	3.5 km	14	2	120 - 300 mA



## Spiral Ground/Retaining Anchor for Solar Units

- total height of ground anchors (incl. thread) 120 cm
- suitable for SunPower S 4000, S 3800, S 3000, S 2400 smart and S 1500

Included in Delivery: 1 x spiral ground/retaining anchor, 1 x screw set, 1 x Screw-in assistance



Ref. no.	Height		€
442383	120 cm	1	

solar unit not included

## Wooden Post Mount

- for theft-proof mounting on the wooden post
- incl. padlock and spare key
- incl. metal and wood screws
- suitable for SunPower S 4000, S 3800, S 3000, S 2400 smart and S 1500



Ref. no.	Material		€
442384	Stainless Steel	1	

solar unit not included

# Sun Power S

Made in Germany



- optimised for permanent, maintenance-free operation right through the main pasture season
- with High/Low/Off switch
- power saving switch for when battery voltage fails
- integrated lightning protection
- intelligent, modern battery management with deep discharge protection – device functions even during extended periods of bad weather
- excellent level of efficiency – therefore a longer battery life
- very robust, weather-resistant, water-tight casing with carrying handle
- fast and easy to install
- channel integrated into the housing for post mounting
- microprocessor controlled
- very bright, clearly visible LED light
- corresponds to applicable EU safety standards

5-year warranty



Tip for longer-term storage (e.g. in winter):

A: Disconnect the 12 volt battery from the solar fence device and only reconnect it for commissioning after storing it.

B: Connect the 230 Volt mains charger with the red (+) and black (-) terminal to the 12 Volt battery and use it to charge the 12 Volt battery for at least 24 hours:

- ... prior to storage
- ... at least every 3 months during breaks in operation
- ... before commissioning

Storage temperature: frost-free up to 20 degrees

IMPORTANT: The 230 Volt mains charger can also remain permanently connected to the battery throughout the entire storage period.



0,8 Joule



New product



function indicator LED (green) plus solar operation LED (blue) plus battery warning LED (red)

## AKO S 6

- highly effective solar device for normal fences without vegetation
- ideal for horse and cattle paddocks
- 5-year warranty\*



Ref. no.			€
372948	1	50	

Included in Delivery: 1 x compact solar device S 6 (fully assembled) \*, 1 x AGM battery, 12 Volt, 7 Ah (441130)\*, 1 x permanently mounted, crystalline solar module, 12 Volt, 8 Watt \*, 1 x 230 volt battery mains charger (371032), 1 x fence connector cable, 1 x ground connector cable, 1 x two-part ground/installation spear (442385), 1 x warning sign, \* Warranty: solar fence device (5 year warranty), solar module (5 year performance warranty), 12 volt battery (6 month warranty)

Model	Ref. no.											
S 6	372948	0.8 J	0.6 J	10,800 V	10,200 V	4,300 V	18 km	6 km	1.7 km	0.2 km	1	31 - 43 mA

Important: If ground is dry, several additional ground rods must be used.



1,4 Joule



0,75 Joule



## Sun Power S 1000

- powerful solar device for normal fence systems with little vegetation
- ideal for horse and cattle paddocks as well as poultry nets
- 5-year warranty\*

function indicator LED (green) plus solar operation LED (blue) plus battery warning LED (red)

Included in Delivery: 1 x High-Power Compact Solar Device Sun Power S 1000 (fully assembled) \*, 1 x AGM battery, 12 Volt, 12 Ah (441124)\*, 1 x permanently mounted, crystalline solar module, 12 Volt, 8 Watt \*, 1 x 230 volt battery mains charger (371032), 1 x fence connector cable, 1 x ground connector cable, 1 x two-part ground/installation spear (442385), 1 x warning sign, \* 5-year warranty (device & solar module) \* 6-month warranty (12 Volt battery)

## Sun Power S 500

- effective solar device for normal fences without vegetation
- ideal for horse and cattle paddocks
- 5-year warranty\*

function indicator LED (green) plus solar operation LED (blue) plus battery warning LED (red)

Included in Delivery: 1 x High-Power Compact Solar Device Sun Power S 500 (fully assembled) \*, 1 x AGM battery, 12 Volt, 7 Ah (441130)\*, 1 x permanently mounted, crystalline solar module, 12 Volt, 8 Watt \*, 1 x 230 volt battery mains charger (371032), 1 x fence connector cable, 1 x ground connector cable, 1 x two-part ground/installation spear (442385), 1 x warning sign, \* 5-year warranty (device & solar module) \* 6-month warranty (12 Volt battery)



Ref. no.			€
372950	1	50	

## Spare Battery

Ref. no.	Voltage	Capacity		€
441124	12 V	12 Ah	1/4	



Ref. no.			€
372949	1	50	

## Spare Battery

Ref. no.	Voltage	Capacity		€
441130	12 V	7 Ah	1/5	

Model	Ref. no.												
S 500	372949	0.75 J	0.55 J	10,800 V	10,200 V	4,300 V	18 km	6 km	1.7 km	0.2 km	1	31 - 43 mA	
S 1000	372950	1.4 J	1 J	11,000 V	10,000 V	5,000 V	35 km	10 km	2.5 km	1 km	4	59 - 87 mA	

Important: If ground is dry, several additional ground rods must be used.

# Sun Power S

Made in Germany



5-year warranty



Use the natural power of the sun!

- optimised for maintenance-free continuous operation throughout the grazing season, on fences where there is little vegetation
- with On/Off switch
- integrated battery charge regulation
- micro-controller controlled
- integrated lightning protection
- intelligent battery management - the device functions even during prolonged periods of bad weather
- excellent level of efficiency – therefore a longer battery life
- very robust, weather-resistant housing
- power-saving switch for when battery voltage decreases

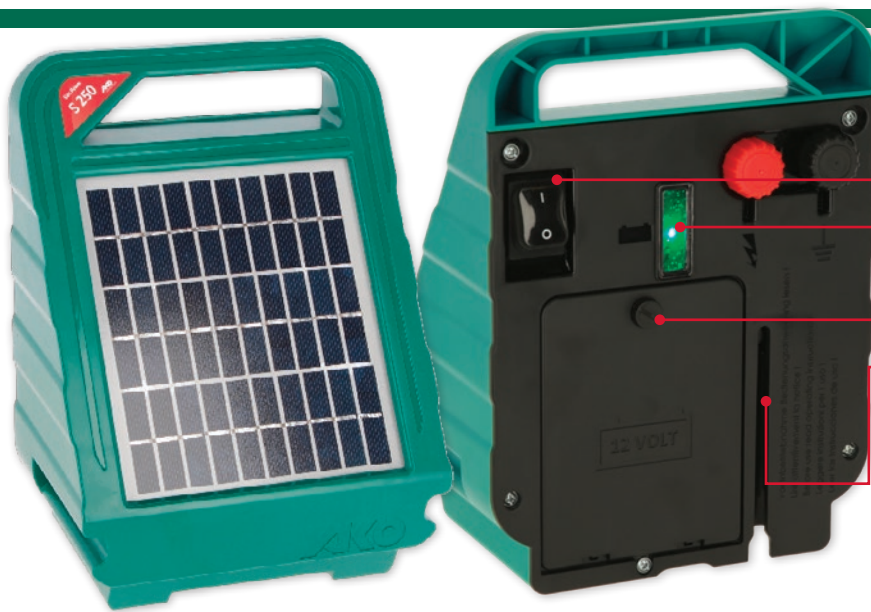

0,4 Joule



On/off switch

function indicator LED (green) plus solar operation LED (blue) plus battery warning LED (red)

Battery compartment

duct for post mounting

Included in Delivery: 1 x solar unit, 1 x integrated 12 V, 5 Ah battery (441218) (6-month warranty), 1 x integrated 12 V, 3 W solar module, 1 x 230 Volt power pack (371032) to recharge the gel battery and/or to trickle charge during the winter months, 1 x connector cable for fence and earth connection, 1 x earth rod, 1 x warning sign

## Sun Power S 250

- highly effective compact solar device
- ideal for hose paddocks and smaller fence systems without vegetation
- deep discharge protection for battery voltage < 11.2 volt - (if activated => only red flashing)
- 5-year warranty

function indicator LED (green) plus solar operation LED (blue) plus battery warning LED (red)



Ref. no.			€
372920	1	90	
372920-RE	1	90	

372920-RE:  
• from recycled plastic



Ref. no.	Description		€
441218	AGM Spare Battery 12 Volt, 5 Ah	1/8	

Model	Ref. no.										
S 250	372920	0.4 J	0.25 J	10,500 V	10,500 V	2,800 V	6 km	3 km	0.7 km	1	22 mA
S 250	372920-RE	0.4 J	0.25 J	10,500 V	10,500 V	2,800 V	6 km	3 km	0.7 km	1	22 mA

Tip for longer-term storage (e.g. in winter):

A: Disconnect the 12 volt battery from the solar fence device and only reconnect it for commissioning after storing it.

B: Connect the 230 Volt mains charger with the red (+) and black (-) terminal to the 12 Volt battery and use it to charge the 12 Volt battery for at least 24 hours:

a) ... prior to storage

b) ... at least every 3 months during breaks in operation

c) ... before commissioning

Storage temperature: frost-free up to 20 degrees

**IMPORTANT:** The 230 Volt mains charger can also remain permanently connected to the battery throughout the entire storage period.

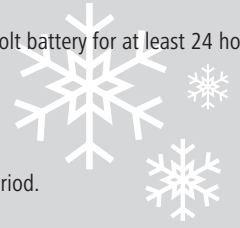

# Solar Technology



Jetzt noch leistungsstärker

The power of the sun supplies the fence and battery with energy: save yourself effort and money on the time-intensive changing and charging of batteries. By allowing a suitably powerful solar module to repeatedly support and charge the rechargeable batter, your fence is supplied with power and requires little maintenance.

## Solar Panel

- 5-year warranty

375201: incl. stainless steel holder for mounting on metal box 44656 or 44650 - for connection directly to 12 Volt battery - solar cable length 100 cm

- incl. Charge Controller

375206: incl. stainless steel holder for mounting and connecting directly to the electric fence - solar cable length 100 cm

375301: incl. stainless steel holder for mounting on metal box 44656 or 44650 - for connection directly to 12 Volt battery - solar cable length 100 cm

- incl. Charge Controller

375306: incl. stainless steel holder for mounting and connecting directly to the electric fence - solar cable length 100 cm

375559: incl. 4 x stainless steel clamping plate + M8 screws, for connection directly to the 12 Volt battery - solar cable length 200 cm. Mounting either on spiral ground/retaining anchor 442382 OR by means of mounting kit 442386 on metal box 44656 or 44650

- incl. Charge Controller

375999: incl. 2 x stainless steel horizontal struts, for connecting directly to the 12 Volt battery - solar cable length 200 cm. Mounting either on spiral ground/retaining anchor 442382 OR by means of mounting kit 442386 on metal box 44656 or 44650.

- incl. Charge Controller

The direct connection to the devices means that no charge controller is required for solar modules 375206 and 375306.

Ref. no.	Output solar module	Width	Height	Depth		€	suitable for
375201	20 W	37.5 cm	37 cm	2 cm	1		X 1000, A 2000, Savanne 2000, X 1600 smart, X 2
375206	20 W	37.5 cm	37 cm	2 cm	1		AD 2000, AD 3000
375301	30 W	37.5 cm	56 cm	2 cm	1		X 2500, X 4000, A 2000, Savanne AM 2000, Savanne AM 3000, X2 smart, X 1600 smart
375306	30 W	37.5 cm	56 cm	2 cm	1		X 2500, X 4000, A 2000, Savanne 2000, Savanne 3000, AD 3000, AN 4000
375559	55 W	53.6 cm	55.7 cm	2.5 cm	1		AN 6000, Xi 8000, AD 5000, X 6000 smart
375999	100 W	66.4 cm	100 cm	3.5 cm	1		XDi 10000, XDi 15000, Xi 8000

## Installation options for the 55 and 100 Watt solar module 375559 and 375999

### A Mounting on the spiral ground/retaining anchor:



#### Items required for this type of mounting:



1. 55 or 100 Watt solar module
2. Spiral ground/retaining anchor set 442382
3. Optional: Solar extension cable 441600

### Spiral Ground/Retaining Anchor

- total height of ground anchors (incl. thread) 120 cm

Set consisting of: 1 x spiral ground/retaining anchor, 2 x stainless steel vertical rail, 1 x screw set, 1 x Screw-in assistance



Ref. no.	Height			€
442382	120 cm	1	77	

solar module not included

### B Mounting on metal box:



#### Items required for this type of mounting:

4. 55 or 100 Watt solar module
5. Metal box assembly set 442386
6. Metal battery case Standard 44656 or anti-theft case 44650

### Metal Box Assembly Kit

- this mounting set also allows the solar module to be optionally installed higher up on a wooden post

Set consisting of: 2 x stainless steel vertical rail, 1 x stainless steel U-holder, 1 x screw set



Ref. no.		€
442386	1/15	

solar module and metal box not included

### Extension Cable Set

- optional cable for extension - especially if the distance from the solar module to the 12 Volt battery is longer than 2 m
- 2 x 5 m cable for the extension of the plus and minus connection
- further extension up to 20 m possible without problems
- only for the 55 and 100 Watt solar module 375559 and 375999

Set consisting of: 2 x 5 m cable for plus/minus extension

Ref. no.	Length	MOQ	Pieces / unit		€
441600	5 m	1 pack	2 / pack	1	



## Solar Module 4 Watt

- 1 x 4 Watt solar module with mount
- suitable for all 9 V devices
- solar module supports or relieves the 9 V battery during daylight hours. The battery energiser draws power from the solar module during daylight hours. The solar module cannot be used to charge to 9 or 12 V battery.



**Important: Device is not included.**

Ref. no.	Output solar module	Width	Height	Depth		€
377024	4 W	21 cm	20 cm	2 cm	1	

## Solar Set 5 Watt

The solar module permanently charges the battery during the main grazing season. The battery can be recharged any time using the 230 volt mains energiser. Recommendation: During winter storage connect the battery to the power pack for 24 hours approx. every 2 months.

Set consisting of: 1 x solar module 5 watts with holder, 1 x AGM battery, 12 V, 15 Ah incl. charging control, 1 x 230-Volt power pack (371012)1 x 230 Volt Netzteil (371012)

Recommendation: During winter storage connect the battery to the power pack for 24 hours approx. every 2 months.



**Important: Device is not included.**

Ref. no.	Output solar module		€
377056	5 W	1	

## 9 volt solar technology

### 9 volt devices with solar module 377024

#### Solar module and 9 volt dry battery:

In contrast to the 12 volt devices, the 9 volt devices are operated directly from the solar modules. During this time, the 9 volt battery is barely impacted. At night and during periods of bad weather, the device is operated from the 9 volt battery. This significantly extends the battery's working life.

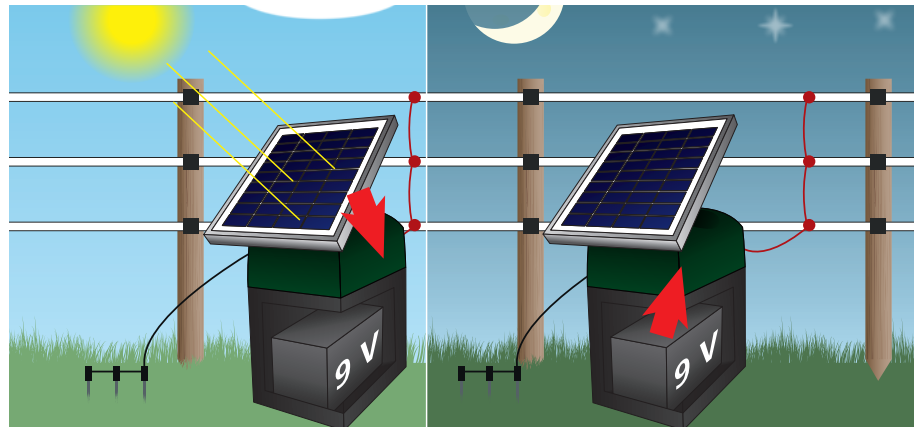

### 9 Volt devices with solar module kit 377056

#### 5 watt solar module and 12 volt battery:

The solar module permanently charges the battery during the main grazing season. The battery can be recharged any time using the 230 volt mains energiser.

- can be used for 9 Volt dry battery devices which are also 12 Volt-capable

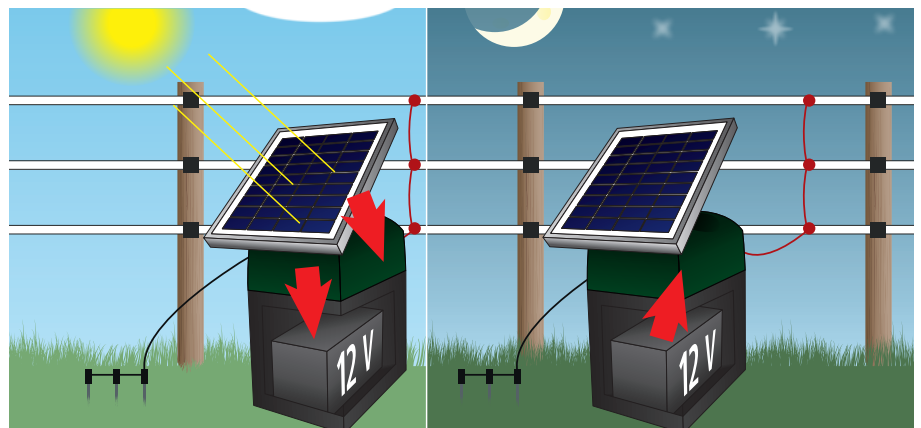



## Anti-Theft-Box

- electrifiable metal battery box made from galvanised steel
- space for one battery unit max. 36.5 cm x 11 cm x 37 cm or all 12 volt devices for wall mounting
- space for one 12 V battery max. 36.5 cm x 21.5 cm x 21 cm
- lockable, lock included in the scope of delivery (incl. spare key)
- with metal carry handle

matching solar modules:

- 375201, 375301
- 375559, 375999 (only with mounting kit 442386)



including solid 80 cm long assembly / ground pole

**Important: Unit and battery are not included!**

Ref. no.	Width	Depth	Height		€
44650	37.5 cm	33,5 cm	37.5 cm	1	

## Metal Battery Boxes

- space for batteries up to 130 Ah
- ideal for use with solar modules
- internal dimensions of battery compartment: W 36 cm x H 32 cm x D 21 cm
- space for one battery unit max. 36.5 cm x 11 cm x 37 cm or all 12 volt devices for wall mounting
- with metal carry handle
- Material: galvanised metal

matching solar modules:

- 375201, 375301
- 375559, 375999 (only with mounting kit 442386)



44652



**Important: Unit and battery are not included!**

Ref. no.	Width	Depth	Height			€
44656	37.5 cm	33.5 cm	37.5 cm	1	24	

Ref. no.	Description	MOQ	Pieces / unit		€
44652	Anti-Theft Kit for Metal Battery Cases	1 pack	1 / pack	1	



# 9 Volt Dry Battery Energizers



## The ideal units for smaller fences and paddocks!

9 V battery units are suitable for shorter fence lengths without vegetation. They are highly mobile and significantly lighter than 12 V units. The 9 V battery runs for several months and can even cover a complete pasture season, depending on the operating time, battery type and size. Once discharged, it cannot be recharged. The units can alternatively also run on a 12 V battery, making them flexible to use.

- including ground rod and fence/earth connection cable
- battery not included

## The advantages at a glance:

- compact and mobile
- flexible to use
- for movable fences and smaller pastures

Made in Germany



## Recommended accessories:

(not included)



Alkaline 9 volt, 175 Ah, item no. 350531



AGM battery 12 Volt, 15 Ah, item No. 441215



Solar support



Ground connection cable 3 m 44635/011



AKO Warning Sign item no. 446513



Ground Rod with round profile item no. 442380



Digital Duo Voltmeter item No. 442328

## Adaptor Cable

- connects 12 Volt wet rechargeable battery
- for connection to all our 9 V electrical fences
- with 2 crocodile clips
- Cable Length: 80 cm

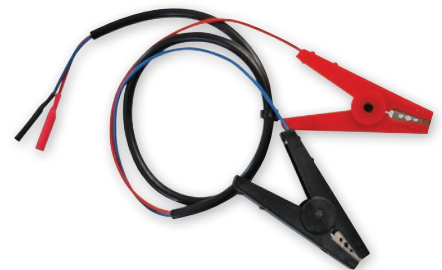

Ref. no.	Colour	Pieces / unit	€
44641/011	black / red	1 / pack	1/90

# Power Station BD

Made in Germany



5-year warranty



- large digital display on top of the device gives the user all key information at a glance – even in darkness
- automatic mode – minimal energy consumption thanks to optimised, independent adjustment of the output power in line with the fence length and status. Battery consumption is therefore minimal and optimum security is maintained over a very large fenced area
- can be operated via 230 V power pack
- allows for optional operation with 12 V battery – with deep discharge protection
- robust, impact-resistant, UV-resistant and weather-resistant housing thanks to the use of high-quality plastics
- very bright, clearly visible LED light
- corresponds to applicable EU safety standards
- incl. foal protection switch option



multi-colour LED bar graph display for monitoring the output voltage



Output voltage in kilovolts



Battery supply voltage in volts and battery status symbol

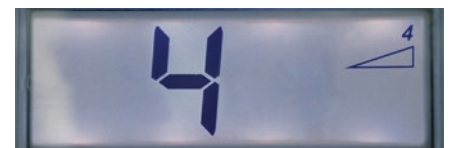

- 1-4: Power levels for normal to extreme fence conditions
- AUTO: Unit automatically selects the optimum power level from 1 to 4

## 230 Volt Power Pack for 9 Volt Battery Units

- only for PowerStation BD and B260 multi



Ref. no.		€
371016	1/14	

# 9 Volt Dry Battery Units Premium



## Power Station BD 600 digital

- our most powerful 9 V battery unit for longer fences and heavy vegetative growth
- highest discharge energy ensures optimum tending safety
- allows for alternative operation with 12 Volt and 230 Volt
- 5-year warranty

## Power Station BD 400 digital

- extremely powerful 9 V battery unit for medium fences and moderate vegetative growth
- the perfect solution for all animal species such as horses, cattle, goats, dogs and poultry
- allows for alternative operation with 12 Volt and 230 Volt
- 5-year warranty

Included in Delivery: 1 x fence unit, 1 x earth rod, 1 x fence / ground connector cable, 1 x warning sign

Included in Delivery: 1 x fence unit, 1 x earth rod, 1 x fence / ground connector cable, 1 x warning sign

Digital display for fence and battery voltage. LED bar graph supports fence voltage control.

Digital display for fence and battery voltage. LED bar graph supports fence voltage control.



Ref. no.			€
372036	1	54	

Ref. no.			€
372034	1	54	

Model	Ref. no.													
BD 400 digital	372034	0.51 J	0.4 J	0.16 J	11,400 V	10,900 V	3,900 V	13 km	8 km	5.5 km	1.7 km	1	17 - 44 mA	
BD 600 digital	372036	0.7 J	0.55 J	0.2 J	11,700 V	10,700 V	4,100 V	18 km	10 km	7 km	2 km	1	17 - 61 mA	

# Power Shock B

Made in Germany



5-year warranty



- visual check for fence insulation and battery voltage
- allows for optional operation with 12 V battery – with deep discharge protection
- robust, impact-resistant, UV-resistant and weather-resistant housing thanks to the use of high-quality plastics
- innovative closure technology
- easy handling
- very bright, clearly visible LED light
- corresponds to applicable EU safety standards



# 9 Volt Dry Battery Units Expert

0,64 Joule



0,45 Joule



## Power Shock B 500 plus

- extremely powerful 9 volt dry battery device
- perfectly suited for horse and cattle paddocks
- increased output power and AUTO mode => minimal energy consumption through optimised, autonomous adjustment of the output power to the fence length and status
- battery unit for long fences and light vegetative growth
- up to max. 0.6 Joules in 12 V mode
- allows for alternative operation with 12 Volt battery
- 5-year warranty

## Power Shock B 290

- powerful 9-Volt universal fence device for small to medium fence systems with little vegetation
- perfectly suited for horse and cattle paddocks
- also ideal for strip grazing
- allows for alternative operation with 12 Volt battery
- 5-year warranty

Included in Delivery: 1 x fence unit, 1 x earth rod, 1 x fence / ground connector cable, 1 x warning sign

Included in Delivery: 1 x fence unit, 1 x earth rod, 1 x fence / ground connector cable, 1 x warning sign

Fence control LED and separate battery warning indicator

Fence control LED and separate battery warning indicator



Ref. no.			€
372030	1	54	

Ref. no.			€
372040	1	54	

The specified fence device values relate to performance level 5

Model	Ref. no.											
B 290	372040	0.45 J	0.29 J	10,500 V	10,500 V	3,300 V	13 km	5 km	2 km		1	17 - 40 mA
B 500 plus	372030	0.64 J	0.5 J	10,000 V	9,500 V	3,700 V	16 km	9 km	6 km	1.8 km	1	17 - 64 mA

# Compact Power B

Made in Germany



5-year warranty



- 9 volt battery units with effective output
- visual check for fence insulation and battery voltage
- easy handling
- allows for optional operation with 12 V battery – with deep discharge protection
- easy to transport
- 6 daylight bright LEDs (bar graph display) for fence and battery monitoring
- includes robust carry handle
- microprocessor controlled
- with large on/off (magnetic) rotary switch
- robust, impact-resistant, UV-resistant and weather-resistant housing thanks to the use of high-quality plastics
- corresponds to applicable EU safety standards



separate LED for battery warning (red)

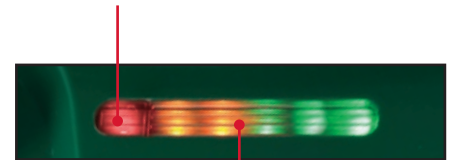

multi-colour LED bar graph display (5 LEDs) for monitoring the output voltage

Large on/off (magnetic) rotary switch



incl. installation ground rod

# 9 Volt Dry Battery Units Classic

0,38 Joule



0,26 Joule



## Compact Power B260 multi

- highly effective 9/12/230 V fence device for mobile use
- for fences with low vegetation
- ideal for horses, cattle, pigs, poultry, dogs, cats and herons
- 5-year warranty

Included in Delivery: 1 x fence unit, 1 x 12 volt adapter cable (44641/011), 1 x 230 volt power pack (371016), 1 x fence / ground connector cable, 1 x installation ground rod, 1 x warning sign

multi-colour LED bar graph display for output voltage and battery control



Ref. no.			€
372026	1	54	

## Compact Power B180

- highly effective 9/12 Volt fence device for mobile use
- ideal for smaller horses and cattle pastures, also suitable for small animals such as dogs and cats
- the cost-efficient 'beginner's' 9 V battery energiser for mobile use in small pastures with little vegetation
- now also available in the on-trend colours of pink and petrol
- 5-year warranty

Included in Delivery: 1 x fence unit, 1 x fence / ground connector cable, 1 x installation ground rod, 1 x warning sign

multi-colour LED bar graph display for output voltage and battery control



Ref. no.			€
372018	1	54	
372018-PETROL	1	54	
372018-PINK	1	54	

Model	Ref. no.										
B180	372018	0.26 J	0.18 J	8,800 V	8,400 V	2,700 V	6 km	3 km	0.5 km	1	23 mA
B260 multi	372026	0.38 J	0.26 J	9,800 V	9,100 V	3,100 V	8 km	4 km	1 km	1	34 mA

# Compact Power



Hobby energisers are ideal for short fences with low vegetation. These devices are especially popular for mobile fences in gardens, mobile paddocks and trail riding. You will also find sets specially developed for these uses on the following pages, which contain everything you need to easily set up an electric fence.

Made in Germany



5-year warranty



N 700: Function indicator LED  
AN 550 and B40: Function indicator LED and battery warning indicator

## Ground/Support Rod

- ideal for DUO and hobby units (available as accessory)
- not compatible with Compact Power B 40 device (372005)
- Material: galvanised metal



Ref. no.			€
44657	1	100	



1,0 Joule



0,85 Joule



0,07 Joule



## Compact Power N 700

Compact, very effective 230 V AKO fence device - ideal as a hobby device for mobile, short fences and suitable for many animal species. With 5-year guarantee and function control LED.

- highly effective 230 Volt fence device for mobile use
- specially designed for short fences
- ideal for horses, cattle, pigs, poultry, dogs, cats and herons
- 5-year warranty

## Compact Power AN 550

Mobile, low-cost 12 V fence device for horses, cattle and small animals - robust, with deep discharge protection, LED display and 5-year guarantee. Ideal as a hobby device for short fences up to 6 km.

- inexpensive, effective 12 Volt fence device for mobile use
- ideal for horse and cattle fences – also for small animals like dogs, cats, poultry, rabbits and herons
- for normal fence systems with low vegetation
- with 12 Volt full discharge protection
- crocodile clips made of high-quality stainless steel
- Low-battery mode: by means of the extended flashing interval (under 12 Volts to 11.5 Volts, pulse and LED flashing is extended to 3.5 sec., under 11.5 Volts, the LED flashes without pulse in an 8-sec. interval)
- battery not included
- solar backup possible
- 5-year warranty

## Compact Power B 40

Compact 3 V fence device as a hobby device - ideal for small, mobile fences up to 200 m, fits in any bag, runs for up to 6 weeks, 5-year guarantee.

- inexpensive, handy 3 Volt fence device
- for mobile use and small fences up to 200 m without vegetation
- ideal for the small fence in the garden, for trail riders and other „small fences“
- operated by 2 x 1.5 V single cell batteries (not included)
- run time with continuous use about 6 weeks
- device fits in any coat pocket
- with on/off switch
- 5-year warranty

Included in Delivery: 1 x Compact Power N 700, 1 x warning sign

Included in Delivery: 1 x Compact Power AN 550, 1 x fence / ground connector cable, 1 x warning sign

Included in Delivery: 1 x Compact Power B 40, 1 x fence / ground connector cable, 1 x warning sign

Function Indicator LED

function control LED and visual battery warning indicator

function control LED and visual battery warning indicator



Ref. no. €  
372080 1 168

Ref. no. €  
372055 1 168

Ref. no. €  
372005 1 168

Model	Ref. no.												
N 700	372080	1 J	0.55 J	8,800 V	7,500 V	1,600 V	21 km	7 km	1 km	0.3 km	1	1	0.9 W
AN 550	372055	0.85 J	0.55 J	8,400 V	7,500 V	1,460 V	23 km	6 km	1 km	0.3 km	1	1	57 mA
B 40	372005	0.07 J	0.03 J	7,000 V	7,000 V	400 V	1 km	0.2 km				1	16 mA

## Portable Fence Kit for Trekking

- assembles and disassembles quickly and easily
  - weight: about 3 kg
- Set consisting of: 1 x battery energiser of 3 V (incl. 2 x 1.5 V batteries), 2 Gate Handles each with 50 m tape, 4 x divisible aluminium posts of 1.15 m length, 5 x expanders with pegs, 8 x insulators for round posts, 1 x carry bag



Ref. no.		€
44127	1/6	

## Hobbyset

- complete electric fence set for garden, pond and pet protection
- comprehensive accessories for quick and easy assembly
- flexibly expandable - ideal for different garden layouts
- robust and weather-resistant for long-lasting use
- Spare parts and accessories available at all times



Set consisting of: 1 x electric fence device, 1 x fence / ground connector cable, 10 x fibreglass poles, green 70 cm, 30 x wire clips, 1 x 100 m poly wire green, 1 x earth rod, 1 x warning sign, 6 x ring insulators with wooden thread



Ref. no.	Description	Pieces / unit		€
441150	with N700 power supply (230 Volt)	1 / pack	1	
441151	with B40 battery unit (operation with 2 x 1.5 Volts)	1 / pack	1	

Ref. no.	Description	Colour	Material	Length	MOQ	Pieces / unit		€
441853	Spare Post	green					1/100	
444265/30	Spare Spring for fibreglass rods of diameter 10 mm		Stainless Steel		1 pouch	30 / pouch	1/30/1500	
44874-100	Poly Wire	green		100 m	1 pieces	1 / pieces	1/20	

## Tournament / Paddock Set 7 x 7 m

- Tournament / Paddock set for approx. 7 x 7 m
- metal posts are ideally suited for dry and rocky ground
- no catching of mane or tail hair
- everything complete in one carry bag
- set up and dismantled in just a few minutes
- weight with device: 13.5 kg, without device: 12.5 kg

Set includes: 4 x metal post galvanised with 153 cm total height, each comes with 4 x FlexiRope incl. gate handle with galvanised hook and matching gate insulators



Ref. no.	Description		€
446500	without Fence Device	1	
446501	with Fence Device Compact Power B 40 (incl. 2 x 1.5 Volt batteries)	1	

## What does C100 mean when referring to the capacity of a rechargeable battery?

The usable capacity of a rechargeable battery is heavily dependent on the amount of discharge current. Since the rechargeable battery is completely discharged during a measurement, a discharge over a longer period (e.g. 100 hours for C100) means that the discharge current is much lower than during a rapid discharge (e.g. 20 hours at C20; C20 always applies when no other data are provided). As a result, a rechargeable battery in an application with very low discharge current has a higher usable capacity than when the same rechargeable battery is used within a shorter timespan and thus at a higher discharge current.

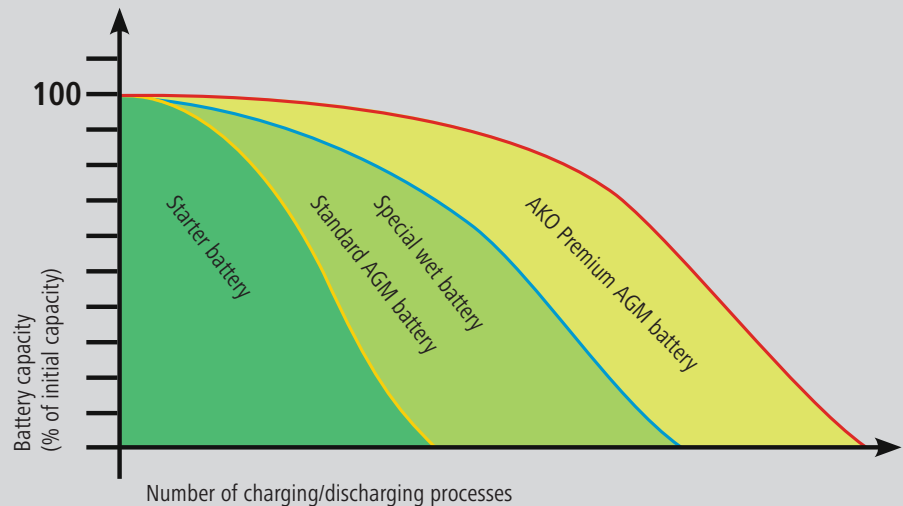

## Special Wet Rechargeable Battery 12 Volt

- extremely low self-discharge
- ideal for 12 V battery units with or without solar panel
- designed especially for fencing units due to its slow charge and discharge cycles
- acid: sulphuric acid 37 % = density of 1.28
- supplied without acid
- when not in use, the battery must be charged at least once a month
- „dry pre-charged“ battery
- charge completely after filling with acid
- capacity data for a 100-hour standard discharge (C100)
- 1-year warranty (note: warranty does not cover deep discharging)



**Important: for safety reasons, the batteries are supplied without battery acid. We recommend that they be filled by a professional „on site“!**

Ref. no.	Voltage	Capacity	L x W x H	Weight	Battery Acid			€
442061	12 V	100 Ah	278 mm x 175 mm x 190 mm	12.7 kg	3.7 L	1	64	

## Battery Charger

for 12 Volt wet batteries and premium AGM batteries

- the multi-stage battery charger allows batteries to be charged to almost 100 % of their original capacity thanks to state-of-the-art technology
- automatic diagnosis, restoration, charging and maintenance of batteries over months thanks to fully automatic switching between charging and maintenance mode
- the following output options are available: 28.6 V, 29.2 V, 14.3 V, 14.6 V
- Charging current with 12 Volt battery: 2 A, 5 A and 10 A
- Charging current with 24 Volt battery: 2 A and 5 A
- no risk of over-charging
- electronically secured against user error
- spark-proof
- overheating protection with mini fan inside
- fully protected against short-circuits and incorrect connections
- suitable for charging and maintaining electric fence batteries as well as car batteries



Ref. no.		€
371037	1/8	



## AGM Battery



- rechargeable AGM Fleece Battery
- filled and charged, ready to install immediately
- 1-year warranty (does not cover deep discharging)
- Capacity data for a 100-hour standard discharge (C100)
- low self-discharging compared to standard batteries
- in OEM quality
- better charging behaviour (e.g. when charging via solar modules) and longer performance, even with short charging and discharging cycles (= more micro-cycle resistant) than conventional AGM batteries or standard lead-acid batteries
- can be stored for at least 9 months
- leakproof: double cover with safety valve, gas recombination and backfire protection

- No acid required
- Completely leak-proof
- Maintenance-free – user-friendly

Made in the EU



## Premium AGM Battery

- immediately ready for use
- 1-year warranty (note: warranty does not cover deep discharging)



The new alternative to popular lead-acid batteries. The AGM fleece technology makes topping up battery acid a thing of the past. Fleece batteries are completely leak-proof, maintenance-free and extremely cycle-resistant.

All AKO AGM batteries also fit in metal boxes 44656 and 44650

Ref. no.	Voltage	Capacity	Length	Width	Height	Weight		€
442067	12 V	75 Ah	242 mm	175 mm	190 mm	17.9 kg	1	76
441203	12 V	88 Ah	275 mm	175 mm	190 mm	20.7 kg	1	68
441204	12 V	110 Ah	353 mm	175 mm	190 mm	26.4 kg	1	48

**IMPORTANT: AGM batteries are closed systems. Opening the battery voids the warranty!**

### Expert tip:

#### How to calculate the run time of your 12 volt battery:

1. Usable capacity = rated capacity x 0.65
2. Energy consumption of device (Ampere) = energy consumption in mA (see device type plate, e.g. 120 mA) : 1000
3. Operating period (hours) = usable capacity: energy consumption

#### Example:

1. 88 Ah x 0.65 = 57.2 Ah
2. 120 mA : 1000 = 0.120 A
3. 57.2 Ah : 0.120 A = 476 hours (19 days)



## Premium AGM Battery 32

- immediately ready for use
- for all 9 Volt devices that are also designed for 12 Volt operation
- must be installed lying on its side for some 9 V unit types
- incl. connection cable for 9 Volt devices
- 1-year warranty (note: warranty does not cover deep discharging)



ideal for 9 V devices

**IMPORTANT: AGM batteries are closed systems. Opening the battery voids the warranty!**

Ref. no.	Voltage	Capacity	L x W x H	Weight		€
441250	12 V	32 Ah	165 mm x 175 mm x 125 mm	7.8 kg	1	120

## Premium AGM 15 Ah Complete Set

- for all 9 Volt devices that are also designed for 12 Volt operation
- the rechargeable 12 Volt, 15 Ah (C100 or 12 Ah according to C20) AGM battery can be recharged via a power pack
- the integrated charger controller prevents overcharging and protects against deep discharge
- an optional 5-Watt solar module can be connected during grazing periods for continual operation (= complete set: 377056)
- 1-year warranty (note: warranty does not cover deep discharging)



ideal for 9 V devices

Included in Delivery: 1 x AGM battery 12 V, 15 Ah (C100) incl. charging control, 1 x 230 Volt power pack

Ref. no.	Voltage	Capacity	L x W x H		€
441215	12 V	15 Ah	150 mm x 100 mm x 115 mm	1/4	

## Battery Tester

- test range 6 - 20 volts
- The open-circuit voltage (at the beginning) and the voltage under load (after the -- characters) are displayed.
- after a short while, the display shows „OF“ - the battery tester switches off automatically to protect the battery
- no batteries required



Ref. no.	Colour	Voltage Levels		€
442369	black	6 - 20 V	1/16	

## Saline Dry Battery 9 Volt High Energy

with carrying strap

„More power for less money“

- inexpensive, powerful alternative to alkaline batteries
- extended service life thanks to zinc-carbon technology
- ideal for all common standard 9 volt battery units



Ref. no.	Voltage	Capacity	Length	Width	Height	Nominal Voltage		€
44220	9 V	75 Ah	165 mm	115 mm	110 mm	8.4 V	1/4	360

## Dry Battery Alkaline 9 Volt

- alkaline technology ensures consistently high voltage and a long service life - ideal for use in fence devices
- compatible with all standard 9 Volt fence devices and versatile for cattle, horses, sheep and more
- free from mercury and cadmium
- maintenance-free in use, leak-proof and immediately ready for operation - simply insert, connect and get started reliably

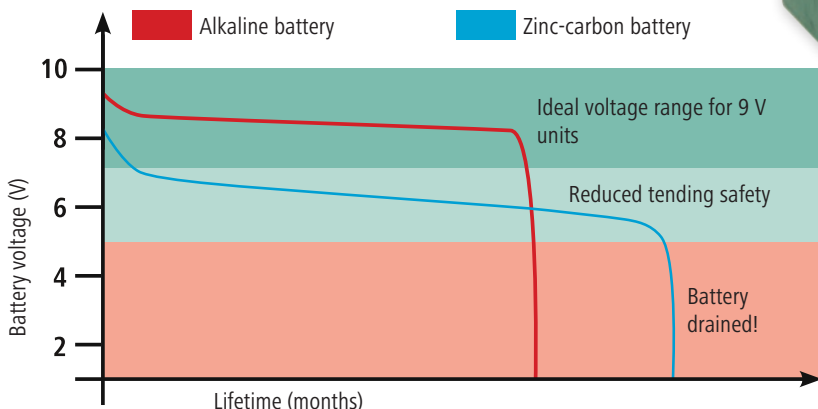

350537: duo pack (2 x 175 Ah)

Alkaline Battery Display 350495 includes:  
9 x 175 Ah, ref. no. 350531  
18 x 120 Ah, ref. no. 350522



very good price/performance ratio  
All prices include disposal fee!

Ref. no.	Voltage	Capacity	Length	Width	Height			€
350611	9 V	55 Ah	165 mm	110 mm	110 mm	1/4	360	
350681	9 V	75 Ah	165 mm	110 mm	110 mm	1/4	360	
350522	9 V	120 Ah	165 mm	110 mm	110 mm	1/4	360	
350528	9 V	170 Ah	190 mm	125 mm	160 mm	1/4	216	
350531	9 V	175 Ah	190 mm	125 mm	160 mm	1/4	216	
350537	9 V	175 Ah	190 mm	125 mm	160 mm	1	108	<b>PROMO</b>
350534	9 V	210 Ah	190 mm	125 mm	160 mm	1/4	180	

## Zinc-Carbon Dry Battery

- standard dry battery for use in electric fence equipment not designed for high power



All prices include disposal fee!

Ref. no.	Voltage	Capacity	Length	Width	Height	Nominal Voltage			€
44212	9 V	55 Ah	165 mm	115 mm	110 mm	8.4 V	1/4	360	
44213	9 V	90 Ah	190 mm	130 mm	160 mm	8.4 V	1/4	216	
44219	9 V	130 Ah	190 mm	130 mm	160 mm	8.4 V	1/4	216	

# Testing and Control Equipment

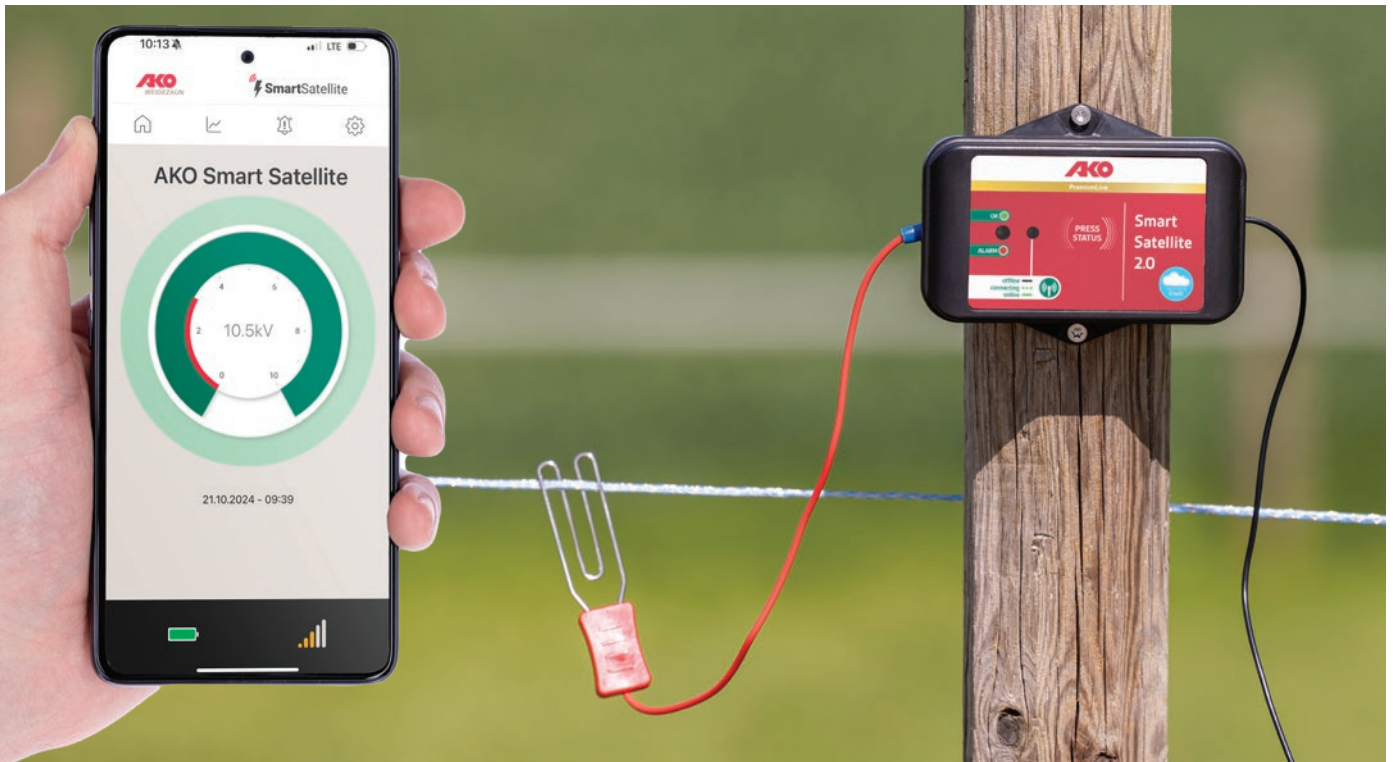

## AKO Smart Satellite 2.0

- smart fence tester / can be controlled via smartphone app or computer browser
- constant control (24/7)
- direct cloud connection (no WiFi required and no connection to a different central device, e.g. gateway, is needed)
- the AKO Smart Satellite 2.0 in combination with the Kerbl Welt app allows you to check the fence voltage at any time in real time and from any location
- if the pre-set minimum protective voltage is not reached, the user is notified with a real-time alarm message
- the smart fence tester operates entirely independently of the fence device used in the fence system
- multiple smart fence testers can be used in a single fence system in order to improve the protective safety and any number of satellites can be monitored with one user account
- unlimited number of smart devices and users can be linked

Made in Germany



New product



free app download & no follow-on costs for the app, as well as mobile data transfer for the app

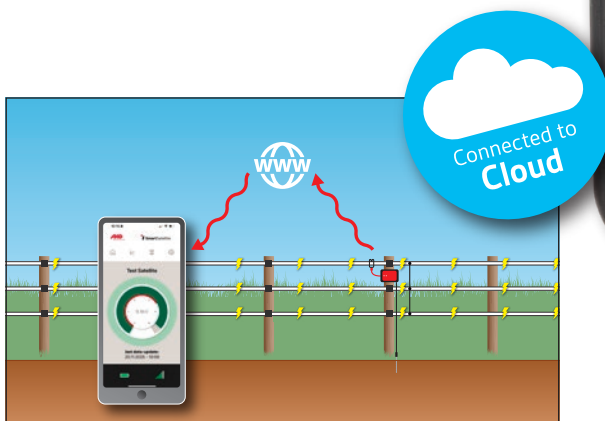

Ref. no. €  
441145 1/34

Included in Delivery: 1 x AKO Smart Satellite 2.0, 2 x AA batterie, 1 x earth cable with ground rod, 1 x fence connector cable



## Digital DUO Voltmeter

Digital AKO "All-in-One" DUO voltmeter checks the voltage of fence devices, electric fences and 9 volt or 12 volt batteries. Conventional fence voltmeters only measure the fence (high) voltage and cannot read the lower battery voltages. Multimeters can test batteries but are damaged when testing the high voltages of electric fences. AKO's DUO voltmeter measures both high and low voltages with a single, inexpensive tool.

- All-in-one features:
- measures the high voltage on the device or fence in kilovolts (0.5 - 13.0-> 500 - 13,000 V) and the battery voltage in Volts (from 3 - 18 V). Values above this are indicated by „Hi“.
- digital display enables the precise display of the measured value
- lightweight and simple to use
- extra-long battery life thanks to power saving technology -> Lo = Low Batt Info
- operated with: 1 x 9 V Block Battery
- battery included



Ref. no.	Colour		€
442328	black	1/80	

## Digital Defect Finder

- for precise troubleshooting of your electric fence. This device has a dual function – it is both a digital fence voltage tester and ammeter. This means you can easily detect potential error sources in your fence.
- Respective illuminated direction indicators help you to do so.
- operated with: 1 x 9 V Block Battery
- battery included

our multimeter has the advantage over conventional test equipment

- convenient and safe application due to ergonomic housing
- universal contact clips suitable for all conducting materials
- convenient measurement through automatic earthing

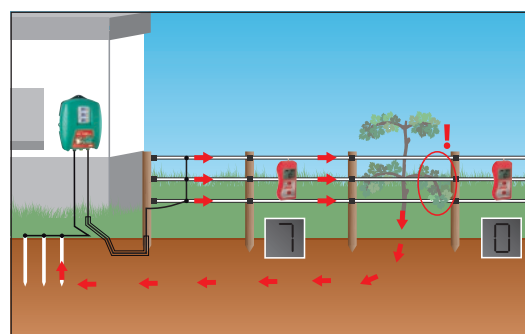

Ref. no.		€
442562	1/25	





## Fence Tester with LED Display

- easy measuring without ground spike
- measure directly on the conductor material
- shows the voltage via nine bright diodes in nine stages up to 10,000 Volts
- additional LED display (centre) for battery status (9 Volt block)
- operated with: 1 x 9 V Block Battery
- battery included



Ref. no.	Colour	Measurement Levels	Voltage Levels		€
442326	black	9	0 - 10,000 V	1/100	

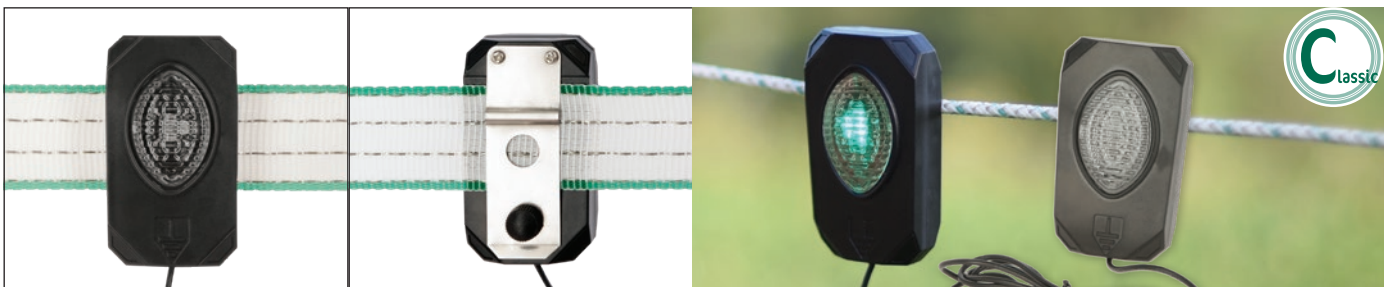

## Pulse Flash

- flashes green with every fence impulse
- under 3000 V light stops flashing and thereby shows that the fence is no longer safe
- using it on several spots on your fence gives you easy visual control of your fence status 'in situ' even during the day
- also ideal as additional defence against wild animals!
- attachment and electrical contact directly with the conductor material
- no batteries required

**Expert Tip:** Place the Pulse Flash at the end of your fence system. You can thus determine at a glance whether at the end of your fence (and therefore throughout your complete system) the voltage is flowing at 3000 Volt. This covers the minimum protective voltage for most animal species on normal soils.

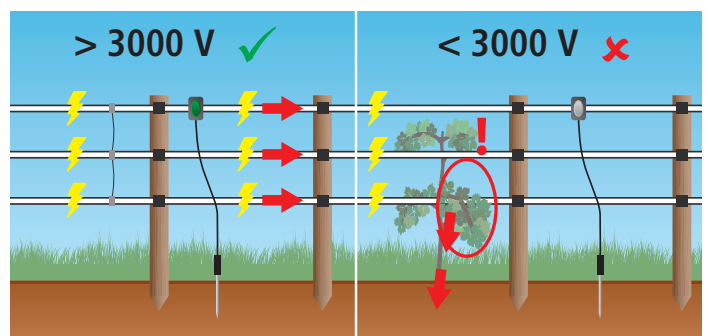

Ref. no.	Colour		€
442373	black	1/50	



## AKO Fence Tester, 8-tier

- for fence voltage measurement
- 8 lights indicate the fence voltage from 1,000 to 10,000 Volts
- facilitates daily checking of the fence tension
- includes ground spike
- no batteries required



Ref. no.	Colour	Voltage Levels		€
442322	black	1,000 - 10,000 V	1/100	

## Fence-Checker

Visual and audible fence tester



- mini handheld display device for electric fences
- emits auditory and visual signals when the fence has a voltage
- incl. battery test function
- easy measuring without ground spike
- operated with: 1 x 12 V Alkaline
- battery included

Perfect for cyclists and walkers!



Ref. no.	Colour		€
441227	black	1	

## Fence Tester

- ergonomic design
- displays the voltage in six stages
- for precise fence measurement
- includes ground spike
- no batteries required



Ref. no.	Colour	Measurement Levels	Voltage Levels		€
441221	red	6	1,000 - 10,000 V	1/80	

# Connection and Grounding Accessories



Tip: Underground cable must be laid in a plastic conduit to prevent damage to the cable!

## High Voltage Underground Cable Premium

- double-insulated with tinned copper conductor
- ideal for supply lines from the device, inside the building, to the ground rod or fence outdoors
- also suitable for connecting several ground rods
- high voltage insulation up to 20.000 Volt



Ref. no.	Colour	Cable Length	Exterior Diameter	Conductor Diameter	Delivery	Conductor Cross-section	Resistance Ω/m			€
440110	green	50 m	7.6 mm	1.6 mm	on a coil	1.5 mm <sup>2</sup>	0.014 Ω/m	1	144	
440111	green	100 m	7.6 mm	1.6 mm	on a coil	1.5 mm <sup>2</sup>	0.014 Ω/m	1	72	

## High Voltage Underground Cable

- double-insulated with galvanized steel wire core
- ideal for supply lines from the device, inside the building, to the ground rod or fence outdoors
- also suitable for connecting several ground rods
- ideal for permanent fence systems
- compatible with all standard 9 Volt, 12 Volt and 230 Volt fence devices - simply connect and conduct safely

44817: Underground cable is not supplied on a reel.



Ref. no.	Colour	Cable Length	Exterior Diameter	Conductor Diameter	Delivery	Conductor Cross-section	Resistance Ω/m			€
44817	black	10 m	6 mm	1.6 mm	no reel	2 mm <sup>2</sup>	0.07 Ω/m	1	500	
44930	black	25 m	6 mm	1.6 mm	on a coil	2 mm <sup>2</sup>	0.07 Ω/m	1	216	
44932	black	50 m	6 mm	1.6 mm	on a coil	2 mm <sup>2</sup>	0.07 Ω/m	1	216	
44933	black	100 m	6 mm	1.6 mm	on a coil	2 mm <sup>2</sup>	0.07 Ω/m	1	117	
44934	black	25 m	7.2 mm	2.5 mm	on a coil	4.9 mm <sup>2</sup>	0.03 Ω/m	1	216	NEW
44931	black	50 m	7.2 mm	2.5 mm	on a coil	4.9 mm <sup>2</sup>	0.03 Ω/m	1	144	
44920	black	100 m	7.2 mm	2.5 mm	on a coil	4.9 mm <sup>2</sup>	0.03 Ω/m	1	72	

Important: item number 44817 is not supplied on a reel!

## High Voltage Underground Cable

- single-insulated with tinned copper conductor (bundled copper wires)
- ideal for supply lines from the device, inside the building, to the ground rod or fence outdoors
- also suitable for connecting several ground rods



Ref. no.	Colour	Cable Length	Exterior Diameter	Conductor Diameter	Delivery	Conductor Cross-section	Resistance $\Omega/m$			€
44630	black	25 m	7 mm	1.32 mm	on a coil	1 mm <sup>2</sup>	0.025 $\Omega/m$	1	216	
44632	black	50 m	7 mm	1.32 mm	on a coil	1 mm <sup>2</sup>	0.025 $\Omega/m$	1	144	

## Fence Power/Ground Connector Cable

- single-insulated with tinned copper conductor (bundled copper wires)
- with M8 eyelets
- ideal for supply lines from the device, inside the building, to the ground rod or fence outdoors
- also suitable for connecting several ground rods



Ref. no.	Colour	Cable Length	Exterior Diameter	Conductor Diameter	Conductor Cross-section	Resistance $\Omega/m$		€
44635/011	black	3 m	7 mm	1.32 mm	1 mm <sup>2</sup>	0.025 $\Omega/m$	1/40	
44936/011	black	10 m	7 mm	1.32 mm	1 mm <sup>2</sup>	0.025 $\Omega/m$	1/15	

## High Voltage Cable Connector

- for the high voltage resistant, water-tight connection of high-voltage cables measuring exterior diameter 5.0 - 8.0 mm

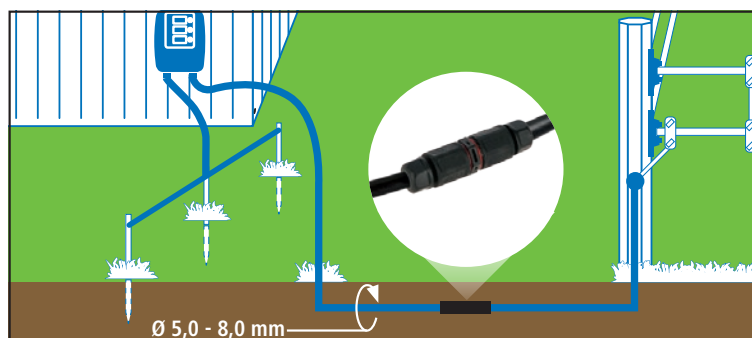

Ref. no.	Colour		€
440121	black	1/100	

# Connection and Grounding Accessories



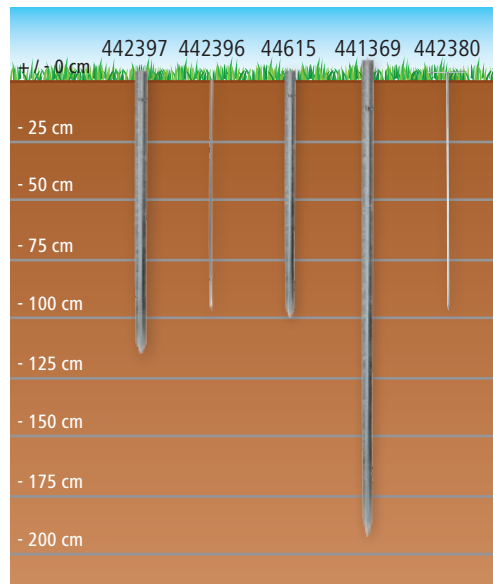
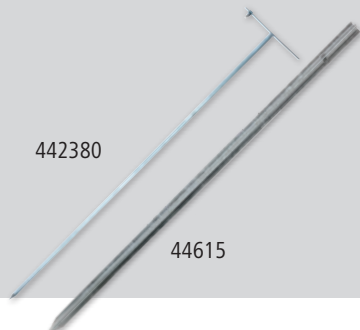

## Expert tip:

- Always insert the ground rods into damp soil.
- Maintain a distance of 3 m between the individual ground rods.
- Use galvanised ground rods – rust has an insulating effect and prevents voltage returning to the unit.



## Professional ground rod

- the ground rod for professionals - 1.20 m long, for real 1 m in the ground for perfect earthing
- solid profile for high mechanical load-bearing capacity - no bending when hammered in
- three holes (M6, M8, M12) for versatile connection of underground cables, also in conjunction with wire connection clamps
- with M6 stainless steel screw
- Material: steel, hot-dip galvanised

Ref. no.	Height			€
442397	120 cm	1	400	

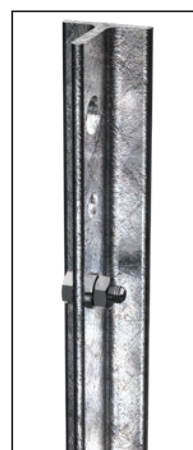



New product

NEW



## Special Ground Rod

- with M6 stainless steel screw for connecting the ground connection cable
- additional M8 and M12 hole for connection of underground cable with wire connection terminal
- Material: steel, hot-dip galvanised

Ref. no.	Height			€
44615	1 m	1	400	
441369	2 m	1	200	



## Special Earth Rod for Mobile Use

- easy to pull out with T-handle
- with M6 stainless steel screw for connecting the ground connection cable
- Material: steel, hot-dip galvanised

Ref. no.	Height			€
442380	100 cm	1	250	



## Ground rod 2-part

- two-part ground rod for the secure earthing of electric fence systems - space-saving, easy to transport and simple to install
- robust, galvanised design for maximum corrosion resistance and long service life in the ground
- simple connection via screw thread - for a reliable hold
- can be individually extended in length
- particularly suitable for mobile applications
- Material: steel, hot-dip galvanised



New product

NEW



Included in Delivery: 2 x ground rod 50 cm, 2 x connecting pin, 1 x connecting screw

Ref. no.	Height		€
442396	100 cm	1/25	

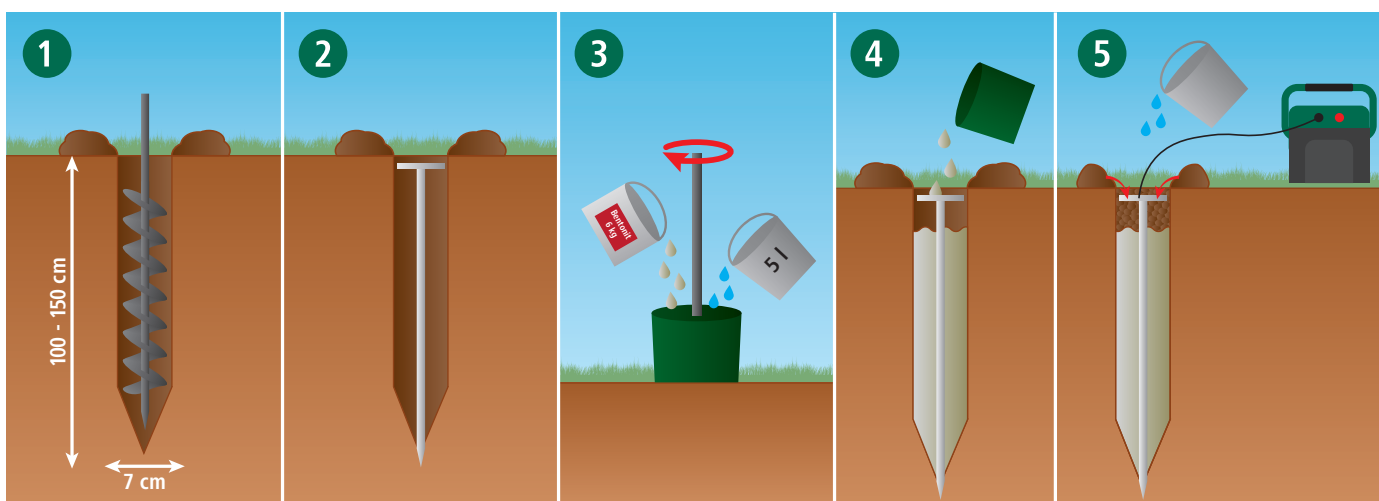

## Earthing Mix Bentonit

- ensures perfect earthing even in difficult earthing conditions (e.g. dry or sandy soils)
- the special mixture of clay and salt attracts moisture and binds it directly in the ground around the earthing rods
- suitable for all kinds of ground rods
- the mass is easy and fast to stir in using 5 litres of water in a suitably large hole prepared for the ground rod
- sufficient for approx. 3 ground rods



Ref. no.	Contents		€
442375	6 kg / Bucket	1	

# Connection and Grounding Accessories

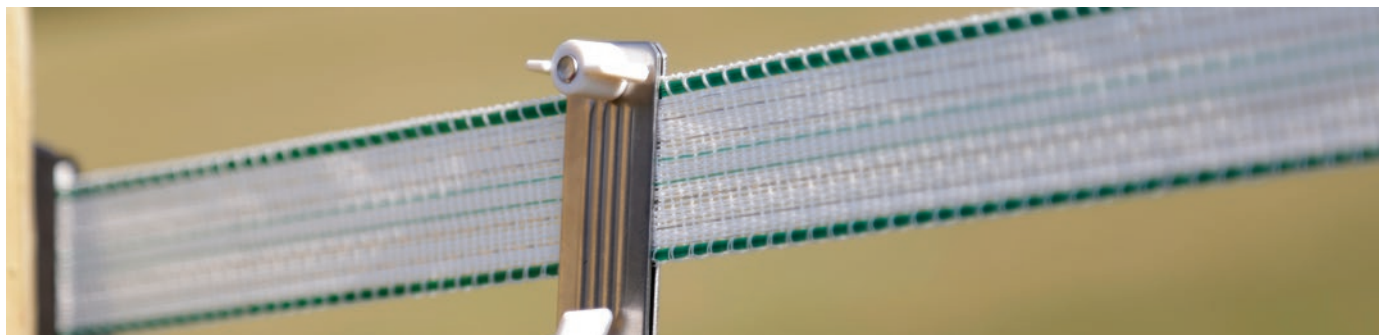

## Tape Connector 3-way

- Stainless steel clamping plates
- Cable length: 2 x 60 cm
- the mechanically and electrically perfect connection between three fencing tapes

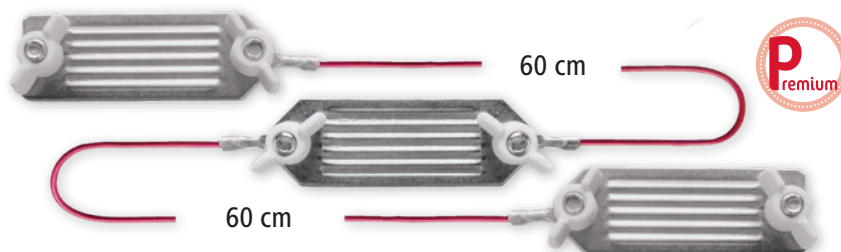

Ref. no.	can be used for	Pieces / unit		€
443027/011	tape up to 40 mm	1 / pack	1/90	

## Tape connector 2-way

- ideal mechanical and electrical connection between two fencing tapes
- Stainless steel clamping plates
- Cable Length: 80 cm

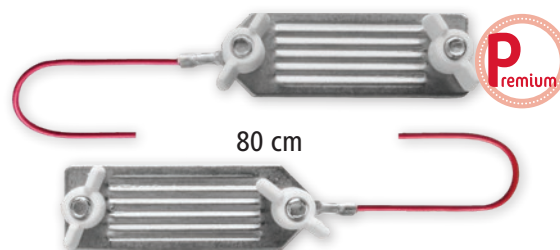

Ref. no.	can be used for	MOQ	Pieces / unit		€
44616/011	tape up to 40 mm	1 pack	1 / pack	1/90	

## Tape Connecting Cable

- the ideal mechanical and electrical connection between fence device and tape
- Stainless steel clamping plates
- with M8 metal eyelet
- Cable Length: 130 cm

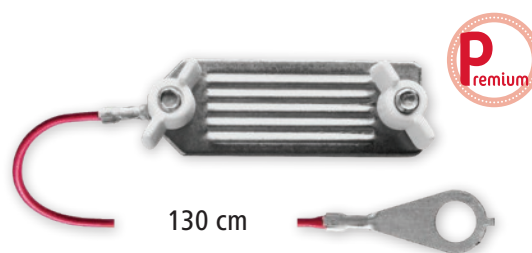

Ref. no.	Colour	can be used for	MOQ	Pieces / unit		€
44617/011	red	tape up to 40 mm	1 pack	1 / pack	1/90	

## Rope / Tape Connector

- the perfect mechanical and electrical connection between pasture fence rope and pasture fence tape
- Stainless steel clamping plates
- Cable Length: 80 cm

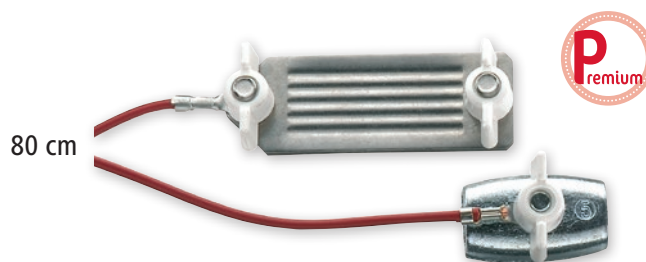

Ref. no.	Colour	can be used for	MOQ	Pieces / unit		€
441493/011	red	rope up to Ø 6.5 mm, tape up to 40 mm	1 pack	1 / pack	1/90	

## Ground and Fence Connector Cable

- Connecting parts made from stainless steel
- adapted contact surfaces of the alligator clips ensure optimal contacting of tapes of 10 - 40 mm width
- ideal connection from the device to the 40 mm fence tape
- with M8 metal eyelet
- Cable Length: 120 cm

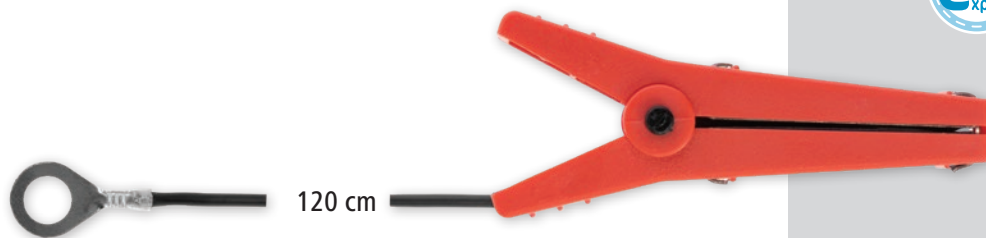

Ref. no.	Colour		€
443038/011	black	1/90	

## Fence Connection Cable, double

- Connecting parts made from stainless steel
- with 2 crocodile clips for electrification of 2-row fence systems having 40 mm fencing tapes
- adapted contact surfaces of the alligator clips ensure optimal contacting of tapes of 10 - 40 mm width
- Cable Length: 60 cm

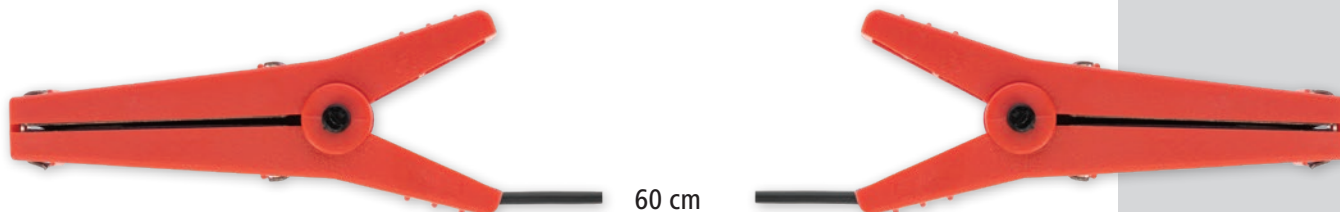

Ref. no.	Colour		€
443028/011	black	1/90	

## Fence Connection Cable, triple

- Cable length: 2 x 60 cm
- Connecting parts made from stainless steel
- with 3 crocodile clips for electrification of 3-row fence systems having 40 mm fencing tapes
- adapted contact surfaces of the alligator clips ensure optimal contacting of tapes of 10 - 40 mm width

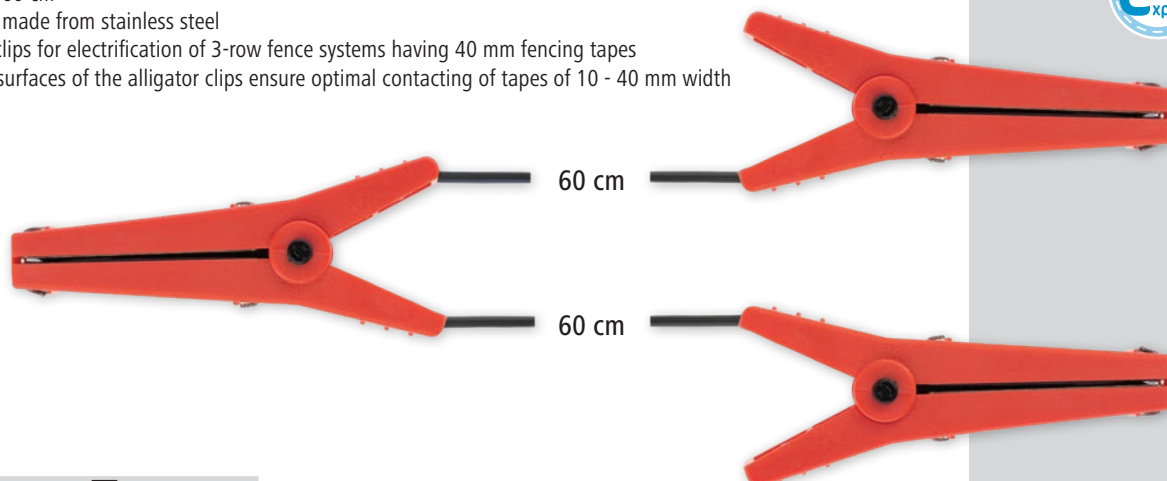

Ref. no.	Colour		€
443029/011	black	1/40	



# Connection and Grounding Accessories

## Ground and Fence Connector Cable

- Connecting parts made from stainless steel
- with M8 metal eyelet
- with crocodile clip
- Cable Length: 100 cm

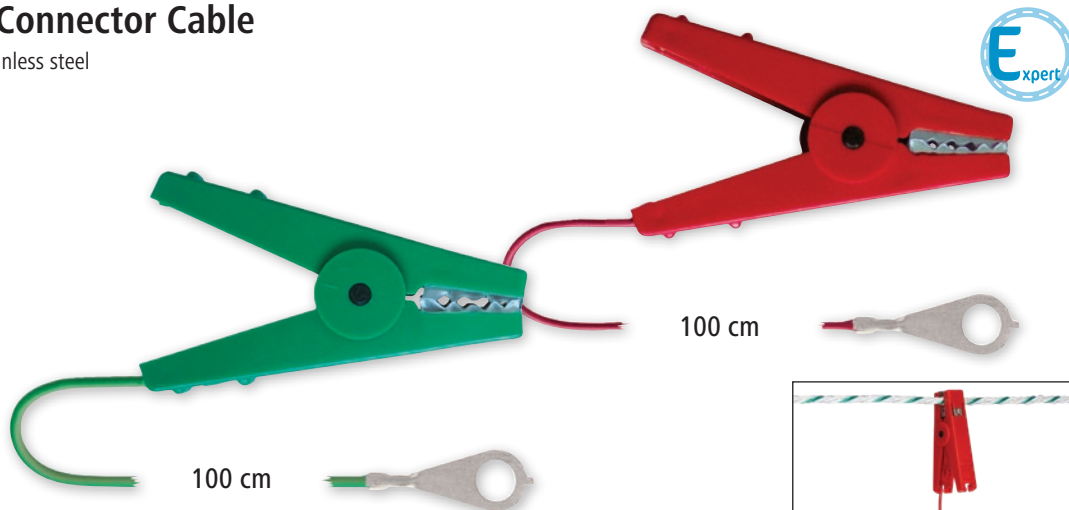

Ref. no.	Colour	MOQ	Pieces / unit		€
44605/011	red	1 pack	1 / pack	1/90	
44606/011	green	1 pack	1 / pack	1/90	

## Fence Connection Cable, double

- Connecting parts made from stainless steel
- with 2 crocodile clips
- Cable Length: 60 cm

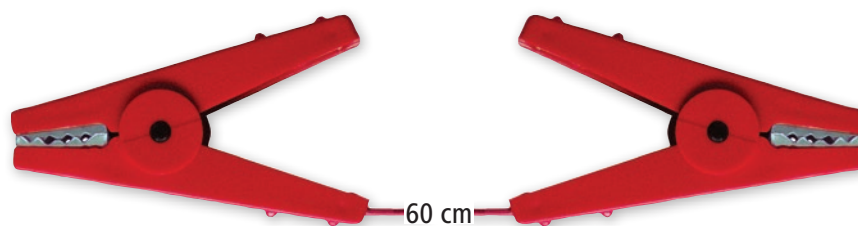

Ref. no.	Colour	MOQ	Pieces / unit		€
441608/011	red	1 pack	1 / pack	1/90	



## Fence Connection Cable, triple

- Cable length: 2 x 60 cm
- Connecting parts made from stainless steel
- with 3 crocodile clips



Ref. no.	Colour	Pieces / unit		€
441601/011	red	1 / pack	1/40	

## Crocodile Clip

- as replacement crocodile clip
- Connecting parts made from stainless steel
- insulated handle

Ref. no.	Colour		€
443039	red	1/10/200	
443040	green	1/10/200	

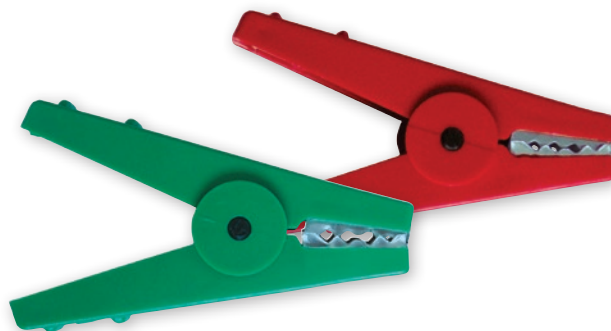

## Ground Connection Cable

- connects fence and ground rod
- with two M8 metal eyelets
- Cable Length: 100 cm

Ref. no.	Colour	MOQ	Pieces / unit		€
44604/011	green	1 pack	1 / pack	1/90	



## Fence Connector Cable Heart Clip

- connects the fence device to the conductor material
- reinforced, thick cable design with sturdy connection to eyelet and terminal
- Connecting parts made from stainless steel
- with heart clip
- with M8 metal eyelet
- Cable Length: 125 cm

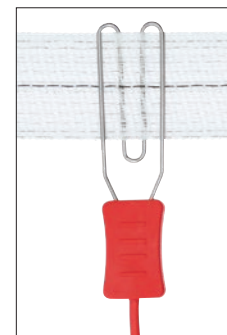
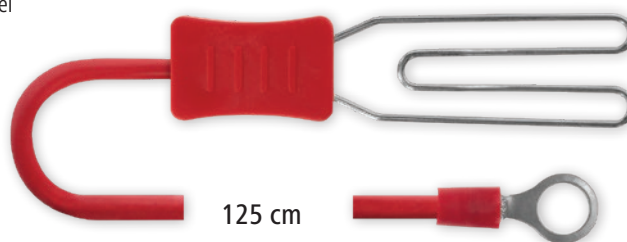

Ref. no.	can be used for		€
443046/011	Rope, Tape	1/90	



## Rope Connecting Cable

- ideal mechanical and electrical connection between energizer and fencing rope
- with M8 metal eyelet
- Cable Length: 150 cm

Ref. no.	Colour	can be used for	Pieces / unit		€
44627/011	red	rope up to Ø 6.5 mm	1 / pack	1/90	



## Rope Connector

- ideal mechanical and electrical connection between two fencing ropes
- Cable Length: 80 cm

Ref. no.	Colour	can be used for	MOQ	Pieces / unit		€
44629/011	red	rope up to Ø 6.5 mm	1 pack	1 / pack	1/90	





## Lightning Protection

- protect your electric fence unit from over-voltage caused by lightning strikes to the fence
- for mounting on a fence post
- the 'lightning protection' takes the over-voltage from the fence directly into the ground through a fixed spark gap
- for mobile battery units
- screw in or nail on
- Material: Plastic

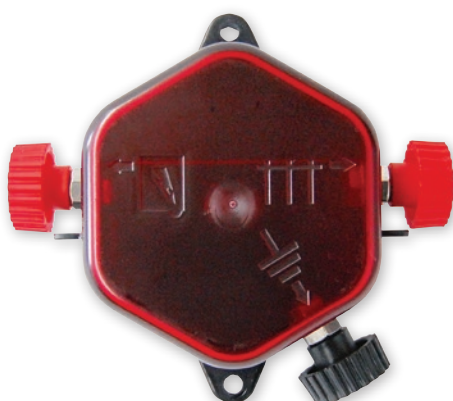

Ref. no.	Pieces / unit		€
449602/011	1 / pack	1	

## Cut-Out Switch

- practical on/off and changeover switch for your fence system
- ideal also for mains operated fence lines
- switches two separate fence systems



4 items possible

I	fence 1 only
II	fence 2 only
I + II	Fence 1 + 2 together
0	Off

Ref. no.	MOQ	Pieces / unit		€
44607	1 pouch	1 / pouch	1/20	
44607/011	1 pack	1 / pack	1	

## Lightning Protection Device

- protect your electric fence unit against overvoltage that can be caused by lightning strikes to the fence system • consisting of lightning protection choke and spark gap • screw-on fastening • Material: galvanised metal



To prevent lightning damage, a lightning protection device (with choke and spark gap) must be installed on non-combustible material on the outside of the building before a fence supply line is introduced into a building.

The lightning protection device must not be connected to the operating earth on the electric fence device.

If a building lightning protection device is present, the earth wire of the lightning protection device should be connected to the earth on this system. Otherwise, a separate earthing system is needed for the lightning protection device.

Ref. no.		€
44601	1/10	



**Top Seller**

## High-power on/off Switch

- extremely sturdy on/off switch for your fence system
- easy assembly on posts



Ref. no.		€
591226	1/25	



## Customised warning signs

You can have warning signs made to your specifications from a minimum order of just 500 units. Simply get in touch and let us supply your motif and desired text. We will create a design and make your custom signs soon after you give your approval.

Extract from the safety standard: Each part of an electric fence that is installed along a public road or pathway must be identified by warning signs at frequent intervals. These must be securely fastened to the fence or firmly clamped to the fence wires.



## Warning Sign – Caution Electric Fence!

- for easy hanging in strips of up to 40 mm, ropes, poly wires and wires
- no further fastening material required
- Material: Plastic
- printed on both sides



Top Seller



Ref. no.	Colour	Length	Width		€
446513	yellow	26 cm	15 cm	1/10/100	

## Warning Sign – Caution Electric Fence!

- Material: Plastic
- printed on both sides



Ref. no.	Print	Colour	Length	Width		€
44620	„Caution Electric Fence!“	yellow	20 cm	12 cm	1/10/250	

## Warning Sign



Available in customer-specific composition.

Ref. no.	Print	Colour	Length	Width		€
44621	“Do not feed.”	yellow	20 cm	12 cm	1/25/250	
44628	“No trespassing.”	yellow	20 cm	12 cm	1/25/400	
446510	„Caution – bull in field.“	yellow	20 cm	12 cm	1/25/500	

## Warning Sign – Electric Fence

- display on public footpaths
- Material: Plastic
- printed on both sides





Ref. no.	Print	Colour	Length	Width		€
44623	Electric Fence	yellow	20 cm	10 cm	1/50/500	

## One-Hand Drop Aid

- one-handed unrolling of conductor material – allows the conductor material to be attached to the insulators at the same time
- for spools of up to 250 mm height and/or weighing up to 3 kg



conductor material not included

Ref. no.	Colour	Material			€
442368	black	Plastic	1/50	900	

## Plastic Reel Super

- very hardwearing plastic reel (replaceable)
- locking pin prevents reel from accidental reeling on
- the ideal aid for fence building
- Drum Mounting: with cotter pin



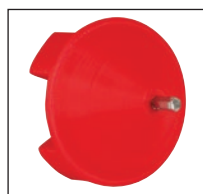

Locking pin



442705  
Roll-up Adapter



Ref. no.	Colour	can be used for		€
44270	black	600 m tape (10 mm), 500 m rope (6 mm), 1,000 m poly wire (3 mm)	1	

Ref. no.	Description	Colour	Material		€
44271	Replacement Drum	black	Plastic	1	
44272	Frame		Metal	1/25	
442705	Roll-up Adapter Easy-Drill	red	Plastic	1/20	

## Reel Super Big

- extra-wide design
- locking pin prevents reel from accidental reeling on
- Drum Mounting: with cotter pin



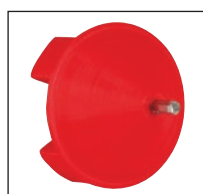

Locking pin



442705  
Roll-up Adapter



Ref. no.	Colour	can be used for		€
441270	black	1,200 m tape (10 mm), 1,000 m rope (6 mm), 2,000 m poly wire (3 mm)	1	

Ref. no.	Description	Colour	Material		€
441272	Frame for Reel Super BIG		Metal	1	
442705	Roll-up Adapter Easy-Drill	red	Plastic	1/20	
441271	Replacement Drum Super Big	black	Plastic	1	

## Euro Reel

- metal hook allows fast electrification of the conductor material on the reel!
- with metal hook
- Drum Mounting: with linch pin

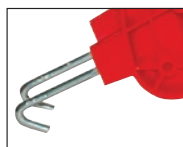

Metal Hook



Top Seller

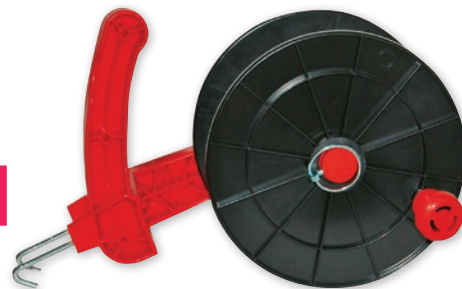

Ref. no.	Colour	Ø Drum	can be used for		€
441041	black / red	18 cm	200 m tape (10 mm), 200 m rope (6 mm), 400 m poly wire (3 mm)	1/5	



Ref. no.	Description	Colour		€
441201	Replacement Drum for Euro reel	black	1/10	

## Poly Wire on Reel

the popular Euroreel (441041) already loaded with 300 m of polywire

Tedious winding of the wire material is dispensed with and the reel is ready for use immediately



Ref. no.	Length	Colour	max. recommended fence length	Resistance	Number of Conductors	Stainless Steel Ladder	Tin-plated copper conductor	Break Load			€
449597	300 m	white / black	6,000 m	0.3 Ω/m	6	5 x 0,2 mm	1 x 0,25 mm	100 kg	1/6	120	

## Euro Reel Eco

- with plastic hook
- Drum Mounting: with linch pin



441040-RE: manufactured from recycled plastic to the same quality standard

Ref. no.	Colour	Ø Drum	can be used for		€
441040	black	18 cm	200 m tape (10 mm), 200 m rope (6 mm), 500 m poly wire (3 mm)	1/5	
441040-RE	anthracite	18 cm	200 m tape (10 mm), 200 m rope (6 mm), 500 m poly wire (3 mm)	1/5	

Ref. no.	Description	Colour		€
441201	Replacement Drum for Euro reel	black	1/10	

## Euro Reel Big

- metal hook allows fast electrification of the conductor material on the reel!
- Drum Mounting: with linch pin

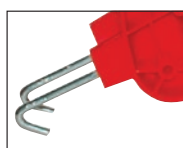

Metal Hook

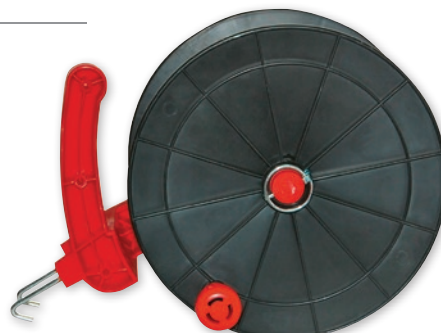



Ref. no.	Colour	Ø Drum	can be used for		€
441042	black / red	24 cm	400 m tape (10 mm), 400 m rope (6 mm), 800 m poly wire (3 mm)	1/5	

Ref. no.	Description	Colour		€
441206	Replacement Drum for Euro Reel Big	black	1/10	

## Super Plastic Reel with Handle and Holder for Mounting on Stands

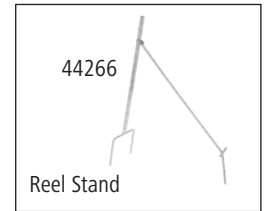
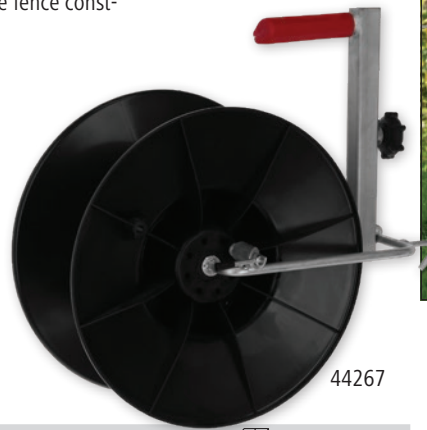
- flexible solution for quickly pulling single-row mobile fences
- can be converted very easily and without tools into a reel system for mobile fence construction in combination with a galvanised reel stand (44266)
- incl. spring mechanism for locking the reel
- easy winding and unwinding of wire, rope and tape
- locking pin prevents reel from accidental reeling on



Ref. no.	can be used for		€
44267	600 m tape (10 mm), 500 m rope (6 mm), 1,000 m poly wire (3 mm)	1	

Ref. no.	Description	Colour	Material		€
44266	Reel Stand Tripod			1	
442705	Roll-up Adapter Easy-Drill	red	Plastic	1/20	
44271	Replacement Drum	black	Plastic	1	

## Compact Reel

- impact-proof plastic guarantees durable use
- special eye for well-directed wire routing
- heavy-duty steel crank arm
- galvanized carry handle for manual use or for clipping into the portable reel system
- with locking ratchet
- holder for clasps (44298) not included in the scope of delivery
- for hanging in the post reel system
- Drum Mounting: with locknut



Ref. no.	Colour	can be used for		€
44296	black	200 m tape (40 mm), 600 m poly wire (3 mm)	1	

## Geared Reel 3:1

- save time by 3-way transmission
- special eye for well-directed wire routing
- impact-proof plastic guarantees durable use
- heavy-duty steel crank arm
- with reliable fixing locknut
- for hanging in the post reel system

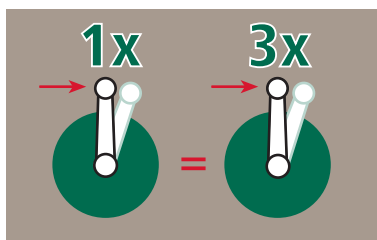

Ref. no.	Colour	can be used for		€
44274	grey	200 m tape (40 mm), 600 m poly wire (3 mm)	1	



# Post reel systems for temporary fencing

## Multi Post

- the ideal solution for corner and gate systems for mobile fencing (plastic, metal)
- holder for clasps (44298) not included in the scope of delivery

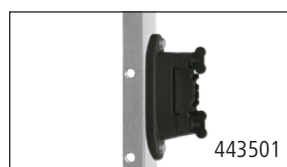
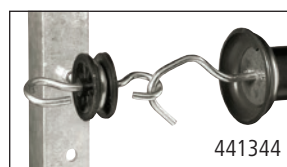
A perfect professional reel system for temporary fencing systems that have to be assembled and disassembled quickly and for many years of use. The indispensable aid for modern fencing.



Ref. no.	Description	Total Height	Material Thickness			€
44297	for max. 3 reels	120 cm	4 mm	1	150	
44299	for max. 4 reels	165 cm	4 mm	1	150	

Ref. no.	Description	Colour	Material	MOQ	Pieces / unit		€
44324	Ring Insulator for Metal Post	black	Plastic	1 pouch	25 / pouch	1/25/500	
441360	Corner Insulator Premium	black		1 pouch	10 / pouch	1/10/250	
44298	Reel Holder		galvanised metal			1/50	
44355/041	Gate / start Insulator for Tapes Premium	black	Plastic	1 pack	4 / pack	1/22	
443501	Corner/Stretch Insulator Premium	black	Plastic	1 pouch	10 / pouch	1/10/200	
441344	Gate / Start Insulator	black	Plastic	1 pouch	10 / pouch	1/10/250	

## Reel Holder

- attaches reel
- with a plastic clamping screw
- Material: galvanised metal
- for hanging reels 44274 and 44296

Ref. no.		€
44298	1/50	

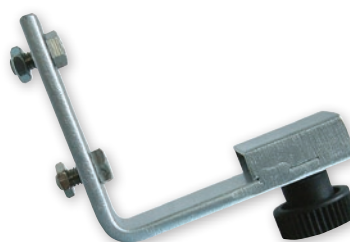

## What kind of conductor material do I need?

There are several points to take into account when selecting the right conductor material. In principle, you have a choice between conductor materials made of plastic (tapes, wires, ropes) in which the current-carrying wires are interwoven with plastic threads, and solid wires made of carbide, which are especially suitable for constructing permanent fences.

When selecting the right wire material, note the resistance in Ohm/m. The lower this value, the better the material conducts electricity. Our proven TriCond material combines high conductivity with a long service life.

### You can find all this information on our packaging:



**0.25 Ω / m**

**7.500 m**

**80 kg**

**2 x 0.20 mm CU**  
**3 x 0.20 mm**  
**INOX**

#### Resistance in Ohm/m:

the lower this value, the better the material conducts electricity.

#### Maximum fence length:

the lower the resistance in Ohm/m, the longer the fences that can be built. In practice, however, this requires low vegetation, excellent insulators, very effective conductor material and an optimised earthing system.

Fence length = single fence length x number of rows

#### Break load:

specifies the max. tensile load in kg before the material tears.

#### Number and material of the conductors:

provides information regarding the conductor specification used. More conductors and a larger diameter result in a lower resistance and therefore higher conductivity.

Fence tape

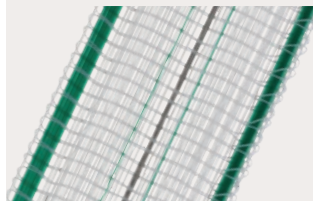

Fence rope



Polywire



Resistance to weather



Visibility



Easy to install



Hard-wearing



We divide our conductor materials into the following quality levels:



**AKO expert tip:** The lower the resistance in  $\Omega/m$ , the better the conductivity.

## Premium PremiumLine & Platinum Line 0 - 50 km

5-year UV stability warranty 

### AKO PlatinumLine series

- Excellent conductivity and resilience
- Ideal for very long fence systems
- especially robust thanks to extra-strong material combination

- Made in Germany

### AKO PremiumLine series

- Excellent conductivity and durability
- Area of use: long to very long fences



~ 0,05-0,25 Ohm/m

## Expert TopLine 0 - 10 km

4-year UV stability warranty 

### AKO TOPLine series

- Optimised price/performance ratio. The lower-cost version with excellent conductivity.
- Area of use: medium to long fences



~ 0,2-0,6 Ohm/m

## Classic EconomyLine 0 - 500 m

3-year UV stability warranty 

### AKO EconomyLine series

- The affordable solution!
- Area of use: ideal for short fences, smaller paddocks and temporary sections



> 1,0 Ohm/m



If a crack should appear in your conductor material, you can repair the problem area very quickly and easily with suitable connectors. We recommend using our patented Litzclip connectors, which allow the damaged areas to be effortlessly reconnected again without any tools. Under no circumstances should conductor material be knotted, as in this case the fine conductor wires would not lie perfectly on top of each other and so a sufficient current flow could not be guaranteed.



# PlatinumLine



PlatinumLine products feature outstanding robustness and durability. With particularly high-quality reinforced monofilaments and extended conductor diameters, they fulfil the highest demands in terms of breaking strength and conductivity. These conductor materials are perfect for long fences and livestock requiring special protection.

**Conductor wires** Many and thick copper or stainless steel conductors for maximum conductivity and thus the best possible shock effect in the event of animal contact.

**Resistance** Particularly low resistance means maximum guarding safety and electrical voltage along the entire length of the fence, even for extremely long fences.

**max. fence length**

**Break load** Reinforced outer edges and extra strong plastic strands for more robustness and a particularly long service life!

## Tape PlatinumLine

- the ideal combination of the best conductivity and increased breaking load combined in one conductor material
- extra-thick monofilaments and reinforced outer edges ensure excellent breaking strength and longevity
- maximum conductivity and protection thanks to the use of thick, galvanised copper wires
- UV-stable and weather-resistant
- high-contrast colour combination for optimum visibility for humans and animals



**PROMO** 442828:  
 • 2 x 200 m length in twin pack  
 • practical double pack with TOP price/performance ratio



We generally recommend the use of stainless steel accessories (connectors, fittings, gate handles)

Ref. no.	Length	Width	Colour	max. recommended fence length	Resistance	Number of Conductors	Stainless Steel Ladder	Tin-plated copper conductor	Break Load	€	
442830	200 m	12 mm	black / white	10 km	0.21 Ω/m	5	4 x 0,2 mm	1 x 0,3 mm	80 kg	1 324	NEW
442831	200 m	20 mm	black / white	13 km	0.15 Ω/m	6	5 x 0,2 mm	1 x 0,3 mm	180 kg	1 144	NEW
442832	200 m	40 mm	black / white	19 km	0.1 Ω/m	10	8 x 0,2 mm	2 x 0,3 mm	450 kg	1 72	NEW
442820	200 m	12.5 mm	white / blue	13 km	0.16 Ω/m	5	3 x 0,2 mm	2 x 0,25 mm	110 kg	1 240	
442821	200 m	20 mm	white / blue	18 km	0.11 Ω/m	6	3 x 0,2 mm	3 x 0,25 mm	180 kg	1 144	
442822	200 m	40 mm	white / blue	30 km	0.06 Ω/m	10	6 x 0,2 mm	4 x 0,25 mm	450 kg	1 60	
442828	400 m	12.5 mm	white / blue	13 km	0.16 Ω/m	5	3 x 0,2 mm	2 x 0,25 mm	110 kg	1 120	

# PlatinumLine

Made in Germany



## Rope PlatinumLine

- the ideal combination of the best conductivity and increased breaking load combined in one conductor material
- because of its smooth surface, the rope is particularly easy to work and can be used everywhere
- proven braiding for maximum stability and durability with improved elasticity
- the conductor wires continuously attached on the outside guarantee optimum contact at all times
- extra thick tin-plated copper wires in combination with stainless steel conductors ensure maximum conductivity and animal safety



Made in Germany



5-year UV stability warranty



woven and therefore extremely robust and resilient



Ref. no.	Length	Ø	Colour	max. recommended fence length	Resistance	Number of Stainless Steel Conductors	Ladder	Tin-plated copper conductor	Break Load		€
442824	200 m	6 mm	white / blue	35 km	0.05 Ω/m	12	8 x 0,2 mm	4 x 0,25 mm	450 kg	1	120
442825	500 m	6 mm	white / blue	35 km	0.05 Ω/m	12	8 x 0,2 mm	4 x 0,25 mm	450 kg	1	48

# PlatinumLine

Made in Germany

- Conductor wires** - Many and thick copper or stainless steel conductors for maximum conductivity.
- Resistance** - Particularly low resistance means maximum guarding safety and electrical voltage along the entire length of the fence, even for extremely long fences.
- max. fence length**
- Break load** - Unique braiding for maximum stability and durability with improved elasticity.
- Cross braiding** - Best possible shock effect in the event of animal contact thanks to conductive wires running along the entire surface.

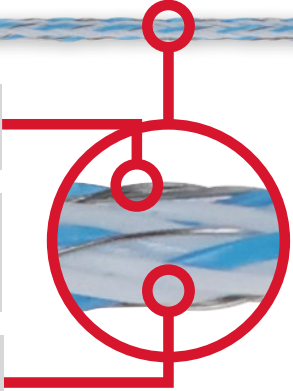

## Poly Wire PlatinumLine

- the ideal combination of the best conductivity and increased breaking load combined in one conductor material
- unique braiding for maximum stability and durability with improved elasticity
- the conductor wires running continuously on the surface guarantee optimum contact at all times
- extra-thick copper wires ensure high conductivity and protection
- UV-stable and weather-resistant



Made in Germany

5-year UV stability warranty

**PROMO** 442829:  
 • 2 x 300 m length in twin pack  
 • practical double pack with TOP price/performance ratio

woven and therefore extremely robust and resilient



We generally recommend the use of stainless steel accessories (connectors, fittings, gate handles)

Ref. no.	Length	Colour	max. recommended fence length	Resistance	Number of Conductors	Stainless Steel Ladder	Tin-plated copper conductor	Break Load		€	
442835	200 m	black / white	20 km	0.1 Ω/m	9	6 x 0,2 mm	3 x 0,25 mm	120 kg	1	324	NEW
442836	400 m	black / white	20 km	0.1 Ω/m	9	6 x 0,2 mm	3 x 0,25 mm	120 kg	1	210	NEW
442823	300 m	white / blue	30 km	0.06 Ω/m	10	6 x 0,2 mm	4 x 0,25 mm	120 kg	1	240	
442827	1,000 m	white / blue	30 km	0.06 Ω/m	10	6 x 0,2 mm	4 x 0,25 mm	120 kg	1	96	
442829	600 m	white / blue	30 km	0.06 Ω/m	10	6 x 0,2 mm	4 x 0,25 mm	120 kg	1	120	

# PlatinumLine

Made in Germany

## Rope PlatinumLine

- the ideal combination of the best conductivity and increased breaking load combined in one conductor material
- thick tin-plated copper conductors – the copper conductors mean that conductivity is 40 times higher than that achieved by traditional conductor materials
- stable stainless steel conductors - ensure a long service life
- high tensile strength for permanent and reliable tension even under high loads
- UV and weather resistant



New product

NEW

Made in Germany



5-year UV stability warranty



We generally recommend the use of stainless steel accessories (connectors, fittings, gate handles)



Ref. no.	Length	Ø	Colour	max. recommended fence length	Resistance	Number of Conductors	Stainless Steel Ladder	Tin-plated copper conductor	Break Load		€
442837	200 m	6 mm	black / white	29 km	0.07 Ω/m	9	6 x 0,2 mm	3 x 0,3 mm	400 kg	1	120
442839	400 m	6 mm	black / white	29 km	0.07 Ω/m	9	6 x 0,2 mm	3 x 0,3 mm	400 kg	1	60

## Poly Wire PlatinumLine

- strong PE threads - ensure consistently high tear resistance in your fencing system
- thick tin-plated copper conductors - the copper conductors mean that conductivity is 40 times higher than that achieved by traditional conductor materials
- stable stainless steel conductors - they also ensure a long service life
- Wire grouping - three linked wires respectively keep the voltage of your fence system at a constant level
- UV-resistant and weatherproof - designed for reliable performance in sun, rain and temperature fluctuations over the long term



New product

NEW

Made in Germany



5-year UV stability warranty



Ref. no.	Length	Colour	max. recommended fence length	Resistance	Number of Conductors	Stainless Steel Ladder	Tin-plated copper conductor	Break Load		€
442833	200 m	black / white	20 km	0.1 Ω/m	9	6 x 0,2 mm	3 x 0,25 mm	100 kg	1	420
442834	400 m	black / white	20 km	0.1 Ω/m	9	6 x 0,2 mm	3 x 0,25 mm	100 kg	1	240



The new generation of connectors: tool-free, fast, reliable  
„Simple but perfect!“



We generally recommend the use of stainless steel accessories (connectors, fittings, gate handles)



## Tape PremiumLine

AKO PremiumLine tapes guarantee the highest conductivity and best tending safety, even on very long runs of fence. The use of thick tin-plated copper conductors means that conductivity is 40 x higher than that achieved by traditional conductor materials.

**Z-webbing** = cross connected wires guarantee permanent re-electrification and thus constant power flow

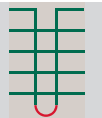

**Wire grouping** = there is a link of two live wires to keep the fence voltage at a constant level

**reinforced outer edges** = high tear resistance

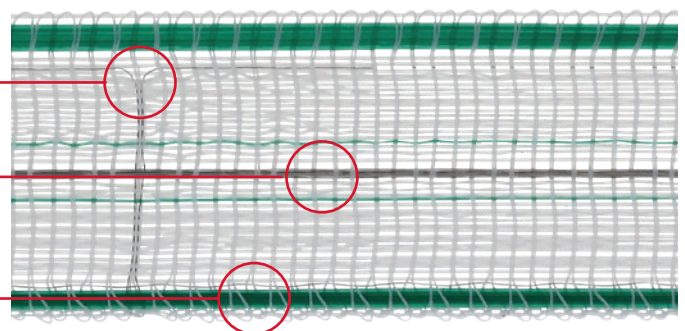

Ref. no.	Length	Width	Colour	max. recommended fence length	Resistance	Number of Conductors	Stainless Steel Ladder	Tin-plated copper conductor	Break Load			€
441533	200 m	12.5 mm	white / green	7.5 km	0.25 Ω/m	5	3 x 0,2 mm	2 x 0,2 mm	80 kg	1/12	144	
441534	200 m	20 mm	white / green	11.5 km	0.17 Ω/m	6	3 x 0,2 mm	3 x 0,2 mm	180 kg	1/6	120	
441535	200 m	40 mm	white / green	15 km	0.13 Ω/m	10	6 x 0,2 mm	4 x 0,2 mm	270 kg	1/2	56	



5-year UV stability warranty



## Tape PremiumLine

AKO PremiumLine tapes guarantee maximum robustness and durability. The particularly strong monofilament fibres and the expanded diameters of our TriCOND™ conductor material fulfil the highest requirements when it comes to breaking load and conductivity.

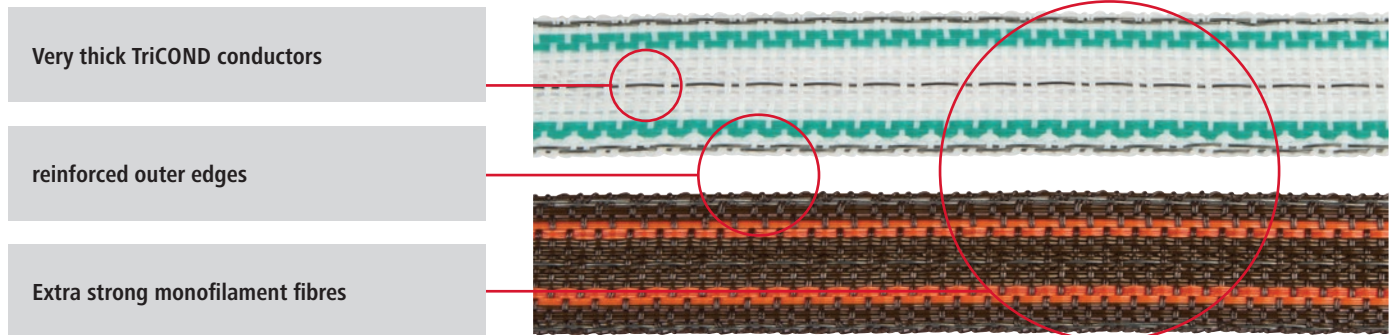

Ref. no.	Length	Width	Colour	max. recommended fence length	Resistance	Number of Conductors	TriCond Conductor	Break Load			€
449123	200 m	20 mm	brown / orange	11 km	0.183 Ω/m	5	0,4 mm	190 kg	1/6	96	
449124	200 m	20 mm	white / green	11 km	0.183 Ω/m	5	0,4 mm	190 kg	1/2	96	
449122	200 m	40 mm	brown / orange	22 km	0.09 Ω/m	10	0,4 mm	350 kg	1/2	48	
449125	200 m	40 mm	white / green	22 km	0.09 Ω/m	10	0,4 mm	350 kg	1/2	48	





4-year UV stability warranty



## Tape TopLine Plus

AKO TopLine PLUS Tapes guarantee excellent conductivity and longevity for medium to long fences. Thanks to the use of our tried-and-tested TriCOND conducting material, compared to rust-proof wires of the same thickness, the tapes, wires and ropes in the TopLine Plus range boast 5 x higher conductivity. In other words, you can use 5 x longer fences or ,transport' 5 x more power to areas in contact with animals = 5 x more security

TriCOND conductor wires have been extensively tested over the last few years and have shown to have a long lifetime. The low resistance of TriCOND wires and the associated high tending safety result in an excellent price / performance ratio. A comparison is worthwhile (resistance in ohm/ metre in relation to the price).

**New TriCOND conductor** = excellent conductivity and long service life

**Strong monofilament fibres** = increased fracture load

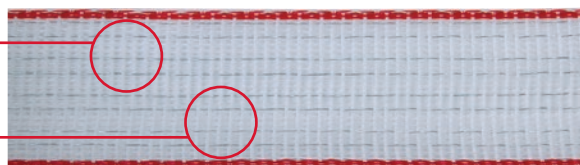

Ref. no.	Length	Width	Colour	max. recommended fence length	Resistance	Number of Conductors	TriCond Conductor	Break Load			€
4491504	200 m	10 mm	white / red	4 km	0.467 Ω/m	4	0,3 mm	90 kg	1/12	240	
4491505	500 m	10 mm	white / red	4 km	0.467 Ω/m	4	0,3 mm	90 kg	1/6	120	
449568	200 m	10 mm	yellow / orange	4 km	0.467 Ω/m	4	0,3 mm	90 kg	1/12	240	
449566	200 m	10 mm	orange	5 km	0.374 Ω/m	5	0,3 mm	90 kg	1/12	240	
449569	200 m	10 mm	blue	5 km	0.374 Ω/m	5	0,3 mm	90 kg	1/12	240	
449567	200 m	10 mm	yellow	5 km	0.374 Ω/m	5	0,3 mm	90 kg	1/12	240	
449550	400 m	20 mm	white / red	5 km	0.374 Ω/m	5	0,3 mm	120 kg	1/2	60	
449551	200 m	20 mm	white / red	5 km	0.374 Ω/m	5	0,3 mm	120 kg	1/6	120	
449563	200 m	20 mm	yellow / orange	5 km	0.374 Ω/m	5	0,3 mm	120 kg	1/6	120	
449570	200 m	20 mm	blue	6 km	0.311 Ω/m	6	0,3 mm	120 kg	1/12	120	
449108	200 m	20 mm	green	5 km	0.374 Ω/m	5	0,3 mm	120 kg	1/12	120	
449554	200 m	40 mm	white / red	10 km	0.187 Ω/m	10	0,3 mm	230 kg	1/2	72	
449109	200 m	40 mm	green	10 km	0.187 Ω/m	10	0,3 mm	230 kg	1/6	48	
449553	200 m	40 mm	brown	10 km	0.187 Ω/m	10	0,3 mm	230 kg	1/6	96	

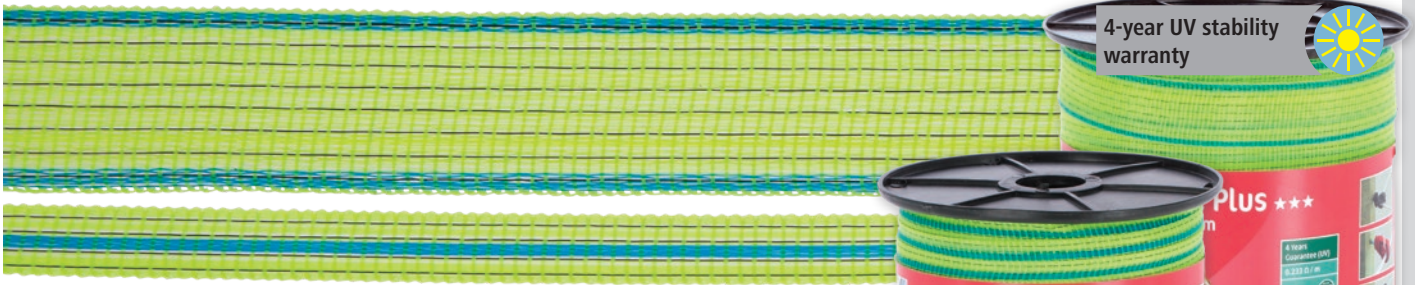

4-year UV stability warranty



## Tape TopLine Plus

• high conductivity and long-term durability for medium-sized to long fence systems



30 mm wide as an ideal compromise between visibility and wind susceptibility

especially good visibility due to luminous neon colours (fluorescent effect)

Ref. no.	Length	Width	Colour	max. recommended fence length	Resistance	Number of Conductors	TriCond Conductor	Break Load			€
449582	200 m	12 mm	neon yellow / blue	4 km	0.467 Ω/m	4	0,3 mm	90 kg	1/12	288	
449583	200 m	30 mm	neon yellow / blue	8.5 km	0.233 Ω/m	8	0,3 mm	230 kg	1/6	96	

## Tape TopLine Plus



4-year UV stability warranty



Ref. no.	Length	Width	Colour	max. recommended fence length	Resistance	Number of Conductors	TriCond Conductor	Break Load			€
449598	200 m	20 mm	white / petrol	5 km	0.39 Ω/m	6	0,25 mm	120 kg	1/12	120	
449599	200 m	20 mm	white / pink	5 km	0.39 Ω/m	6	0,25 mm	120 kg	1/12	120	

## Tape EconomyLine

- plastic made from recycled material with same quality standard
- ideal for short fence lines and strip grazing areas
- sustainable, resource-sparing packaging

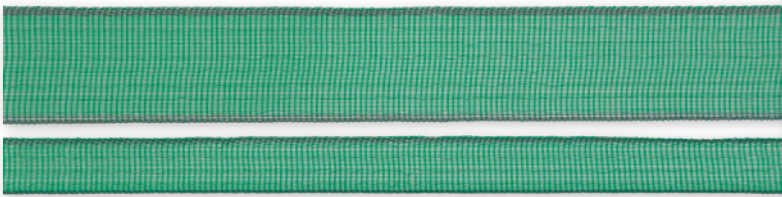

3-year UV stability warranty



standard fence tapes for short fence lines and strip grazing areas

Ref. no.	Length	Width	Colour	max. recommended fence length	Resistance	Number of Conductors	Stainless Steel Ladder	Break Load			€
442811-RE	200 m	20 mm	green / grey	200 m	10.47 Ω/m	4	0,16 mm	90 kg	1/12	216	
442812-RE	200 m	40 mm	green / grey	400 m	5.23 Ω/m	8	0,16 mm	130 kg	1/6	96	

## Tape EconomyLine

- ideal for short fence lines and strip grazing areas

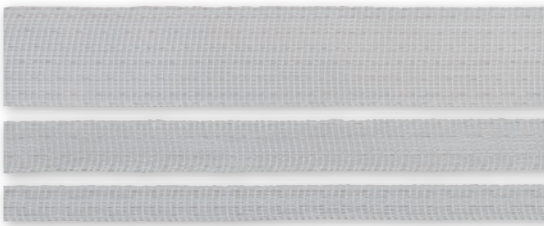

3-year UV stability warranty



standard fence tapes for short fence lines and strip grazing areas

Ref. no.	Length	Width	Colour	max. recommended fence length	Resistance	Number of Conductors	Stainless Steel Ladder	Break Load			€
44550	200 m	12.5 mm	white	200 m	10.47 Ω/m	4	0,16 mm	75 kg	1/12	240	
44556	200 m	20 mm	white	200 m	10.47 Ω/m	4	0,16 mm	90 kg	1/12	240	
44557	200 m	40 mm	white	400 m	5.23 Ω/m	8	0,16 mm	130 kg	1/6	96	

## Fencing Tape Double Pack EconomyLine

- 2 x 200 m length in twin pack

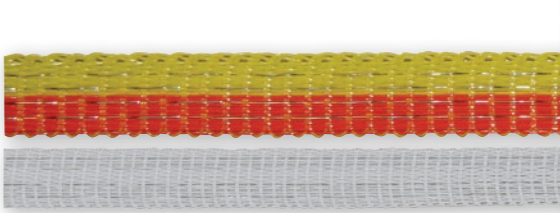

3-year UV stability warranty



standard fence tapes for short fence lines and strip grazing areas

Ref. no.	Length	Width	Colour	max. recommended fence length	Resistance	Number of Conductors	Stainless Steel Ladder	Break Load			€
44565	400 m	10 mm	yellow / orange	200 m	10.47 Ω/m	4	0,16 mm	60 kg	1/6	120	
441525	400 m	10 mm	white	200 m	10.47 Ω/m	4	0,16 mm	60 kg	1/6	120	



The new generation of connectors: tool-free, fast, reliable „Simple but perfect!“



**Top Seller**

5-year UV stability warranty



We generally recommend the use of stainless steel accessories (connectors, fittings, gate handles)



## Rope PremiumLine

AKO PremiumLine ropes guarantee the highest conductivity and best tending safety, even on very long runs of fence.

- thick tin-plated copper conductors – the copper conductors mean that conductivity is 40 times higher than that achieved by traditional conductor materials
- stable stainless steel conductors - ensure a long service life

wire grouping = permanent electrification



extra-strong monofilament fibres = increased fracture load



Ref. no.	Length	Ø	Colour	max. recommended fence length	Resistance	Number of Conductors	Stainless Steel Ladder	Tin-plated copper conductor	Break Load			€
441564	200 m	6.5 mm	white / green	20 km	0.1 Ω/m	9	6 x 0,2 mm	3 x 0,25 mm	425 kg	1/4	72	
441554	400 m	6.5 mm	white / green	20 km	0.1 Ω/m	9	6 x 0,2 mm	3 x 0,25 mm	425 kg	1/2	36	
441519	400 m	6.5 mm	orange / brown	20 km	0.1 Ω/m	9	6 x 0,2 mm	3 x 0,25 mm	425 kg	1/2	36	

## Rope Premium Light

Premium quality at a good price-performance ratio: The highest conductivity and durability through our proven combination of thick tinned copper conductors and robust stainless steel wires at an affordable promotional price.

- increased fracture load thanks to strong monofilament wires
- ideal for long to very long fences

We generally recommend the use of stainless steel accessories (connectors, fittings, gate handles)



5-year UV stability warranty



Ref. no.	Length	Ø	Colour	max. recommended fence length	Resistance	Number of Conductors	Stainless Steel Ladder	Tin-plated copper conductor	Break Load			€
441565	400 m	6 mm	white / blue	13 km	0.155 Ω/m	6	4 x 0,2 mm	2 x 0,25 mm	400 kg	1/2	48	

TriCOND conductor wires have been extensively tested over the last few years and have shown to have a long lifetime. The low resistance of TriCOND wires and the associated high tending safety result in an excellent price / performance ratio. A comparison is worthwhile (resistance in ohm/metre in relation to the price).



## Rope TopLine Plus

The AKO TopLine Plus Rope combines long service and durability with excellent conductivity to create a product that offers top value for money!

- braided structure allows the conductor wires to run continuously on the surface and thus enables optimum contact with animals
- high number of TriCOND conductors means very good conductivity in combination with long durability
- robust plastic fibre core for maximum durability and resistance
- strands of cross-braided PE monofilaments ensure a very high break load with improved elasticity and water-resistant properties



4-year UV stability warranty



woven and therefore extremely robust and resilient

Ref. no.	Length	Ø	Colour	max. recommended fence length	Resistance	Number of Conductors	TriCOND Conductor	Break Load			€
449540	400 m	6 mm	white / red	10 km	0.2 Ω/m	9	0,3 mm	430 kg	1/2	48	

## Rope TopLine Plus

AKO TopLine Plus ropes guarantee excellent conductivity and long-term durability for medium-sized to long fence systems. Thanks to the use of our tried-and-tested TriCOND conducting material, compared to rust-proof wires of the same thickness, the tapes, wires and ropes in the TopLine Plus range boast 5 x higher conductivity. In other words, you can use 5 x longer fences or 'transport' 5 x more power to areas in contact with animals = 5 x more security



4-year UV stability warranty



strong PE monofilament fibres = increased break load

TriCOND Conductor = excellent conductivity and long service life

Ref. no.	Length	Ø	Colour	max. recommended fence length	Resistance	Number of Conductors	TriCOND Conductor	Break Load			€
449532	200 m	6 mm	white / red	6 km	0.311 Ω/m	6	0,3 mm	400 kg	1/2	56	
449531	400 m	6 mm	white / red	6 km	0.311 Ω/m	6	0,3 mm	400 kg	1/2	36	

## Rope EconomyLine



- plastic made from recycled material with same quality standard
- for shorter fence lines and strip-grazing areas
- sustainable, resource-sparing packaging

3-year UV stability warranty



Standard fence ropes for short fence lines



Ref. no.	Length	Ø	Colour	max. recommended fence length	Resistance	Number of Conductors	Stainless Steel Ladder	Break Load			€
442815-RE	200 m	6 mm	green / grey	0.5 km	3.87 Ω/m	6	6 x 0,2 mm	350 kg	1/6	96	

## Rope EconomyLine



- sturdy polypropylene carrier material
- the economical alternative for small fence systems

Standard fence ropes for short fence lines



3-year UV stability warranty



Ref. no.	Length	Ø	Colour	max. recommended fence length	Resistance	Number of Conductors	Stainless Steel Ladder	Break Load			€
44531	200 m	6 mm	white	0.5 km	3.87 Ω/m	6	0,2 mm	350 kg	1/6	96	
441545	500 m	6 mm	white	0.5 km	3.87 Ω/m	6	0,2 mm	350 kg	1/2	32	
44533	200 m	8 mm	white	0.5 km	3.87 Ω/m	6	0,2 mm	700 kg	1/2	48	

## Rope EconomyLine

Unique rope that offers sturdiness, efficiency and excellent visibility. The continual re-electricification of the two thick, highly conductive metal wires ensures maximum reliability. The interior PE monofilaments are UV resistant and extremely durable.

- ideal for horse and cattle paddocks

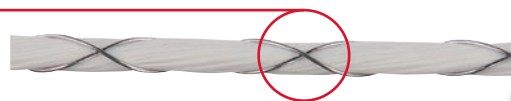

cross wound

Permanent re-electricification through crossing conductors



3-year UV stability warranty



Ref. no.	Length	Ø	Colour	max. recommended fence length	Resistance	Number of Conductors	Galvanised Iron Wire	Break Load			€
441970	200 m	4 mm	white	6 km	0.35 Ω/m	2	0,5 mm	290 kg	1/6	120	

## Poly Wire PremiumLine

- strands of cross-braided PE monofilaments ensure a very high break load with improved elasticity
- permanent re-electrification through conductor bundling and crossing conductors
- conductor wires continuously attached on the outside ensure optimal contact at the animal point of contact



5-year UV stability warranty



woven and therefore extremely robust and resilient

Cross-braided threads made from PE monofilaments = high break force with improved elasticity



6 stainless steel conductors and 3 copper conductors = maximum conductivity and bending stability

Ref. no.	Length	Ø	Colour	max. recommended fence length	Resistance	Number of Conductors	Stainless Steel Ladder	Tin-plated copper conductor	Break Load			€
441979	400 m	2.5 mm	white / green	20 km	0.1 Ω/m	9	6 x 0,2 mm	3 x 0,25 mm	110 kg	1/6	180	

## Poly Wire PremiumLine

AKO PremiumLine Wire guarantees maximum conductivity and herding safety, even for the longest of fences!

- strong PE threads - provide constantly high breaking strength on your fencing system
- thick, tin-plated copper conductors achieve 40 times higher conductivity than conventional conductor materials
- stable stainless steel conductors also ensure a very long service life
- wire grouping - there is a link of two live wires to keep the fence voltage at a constant level.



5-year UV stability warranty



We generally recommend the use of stainless steel accessories (connectors, fittings, gate handles)

Thick PE filaments = Increased breaking load



Wire grouping = permanent electrification with constant high voltage

Ref. no.	Length	Colour	max. recommended fence length	Resistance	Number of Conductors	Stainless Steel Ladder	Tin-plated copper conductor	Break Load			€
441550	250 m	white / green	18 km	0.11 Ω/m	6	3 x 0,2 mm	3 x 0,25 mm	105 kg	1/12	240	
441551	500 m	white / green	18 km	0.11 Ω/m	6	3 x 0,2 mm	3 x 0,25 mm	105 kg	1/4	120	
441738	1,000 m	white / green	20 km	0.1 Ω/m	9	6 x 0,2 mm	3 x 0,25 mm	105 kg	1/2	72	

## Poly Wire Premium WildHog

- specially developed poly wire for deterring wild animals – the blue colour is especially easy to see for wild animals
- thick tin-plated copper conductors – the copper conductors mean that conductivity is 40 times higher than that achieved by traditional conductor materials



5-year UV stability warranty





Top Seller

Blue signal colour = increased visibility for wild animals

6 stainless steel conductors and 3 copper conductors = maximum conductivity and bending stability



Ref. no.	Length	Colour	max. recommended fence length	Resistance	Number of Conductors	Stainless Steel Ladder	Tin-plated copper conductor	Break Load			€
449312	400 m	blue	20 km	0.1 Ω/m	9	6 x 0,2 mm	3 x 0,25 mm	105 kg	1/6	120	
449313	1,000 m	blue	20 km	0.1 Ω/m	9	6 x 0,2 mm	3 x 0,25 mm	105 kg	1/2	56	NEW

## Poly Wire TopLine Plus

AKO TopLine Plus poly wires guarantee excellent conductivity and long-term durability for medium-sized to long fence systems. Thanks to the use of our tried-and-tested TriCOND conducting material, compared to rust-proof wires of the same thickness, the tapes, wires and ropes in the TopLine Plus range boast 5 x higher conductivity. In other words, you can use 5 x longer fences or 'transport' 5 x more power to areas in contact with animals = 5 x more security



4-year UV stability warranty





TriCOND conductor wires have been extensively tested over the last few years and have shown to have a long lifetime. The low resistance of TriCOND wires and the associated high tending safety result in an excellent price / performance ratio. A comparison is worthwhile (resistance in ohm/metre in relation to the price).

TriCOND Conductor = excellent conductivity and long service life

strong PE monofilament fibres = increased break load





Ref. no.	Length	Colour	max. recommended fence length	Resistance	Number of Conductors	TriCond Conductor	Break Load			€
449119	300 m	white / red	3 km	0.623 Ω/m	3	0,3 mm	100 kg	1/12	240	
449523	400 m	white / red	7.5 km	0.26 Ω/m	9	0,25 mm	100 kg	1/6	144	
449120	1,000 m	white / red	7.5 km	0.26 Ω/m	9	0,25 mm	100 kg	1/2	48	
4491558	200 m	white / blue	6 km	0.311 Ω/m	6	0,3 mm	100 kg	1/12	360	
4491559	400 m	white / blue	6 km	0.311 Ω/m	6	0,3 mm	100 kg	1/6	120	

## Poly Wire EconomyLine

- plastic made from recycled material with same quality standard
- ideal for short fence lines and strip grazing areas
- sustainable, resource-sparing packaging

3-year UV stability warranty





Ref. no.	Length	Colour	max. recommended fence length	Resistance	Number of Conductors	Stainless Steel Ladder	Break Load	 	€
442818-RE	250 m	green / grey	250 m	7.74 Ω/m	3	0,2 mm	90 kg	1/12 288	

## Poly Wire EconomyLine

- ideal for short fence lines and strip grazing areas

3-year UV stability warranty



Ref. no.	Length	Colour	max. recommended fence length	Resistance	Number of Conductors	Stainless Steel Ladder	Break Load	 	€
441555	250 m	yellow / orange	250 m	7.74 Ω/m	3	0,2 mm	90 kg	1/15 300	
44520	250 m	yellow / orange	150 m	13.78 Ω/m	3	0,16 mm	60 kg	1/20 420	
44519	500 m	yellow / orange	150 m	13.78 Ω/m	3	0,16 mm	60 kg	1/15 300	

## Rope and Wire Tensioner

- for quick re-tensioning of ropes or wires in an existing fence course
- conductor material does not have to be cut for tensioning
- rotatable, rotating
- no further tool required



Ref. no.	Material	MOQ	Pieces / unit		€
442378	Plastic	1 pack	5 / pack	1/60	

## Polywire Cross-wound EconomyLine

Unique poly wire that offers sturdiness, efficiency and excellent visibility. The continual re-electrification of the two thick, highly conductive metal wires ensures maximum reliability. The interior PE monofilaments are UV resistant and extremely durable.



3-year UV stability warranty



Ref. no.	Length	Colour	max. recommended fence length	Resistance	Number of Conductors	Galvanised Iron Wire	Break Load			€
441972	200 m	white	6 km	0.35 Ω/m	2	0,5 mm	50 kg	1/12	360	
441973	400 m	white	6 km	0.35 Ω/m	2	0,5 mm	50 kg	1/8	288	

## Poly Wire Steuer

The ORIGINAL

- excellent tear resistance
- excellent conductivity thanks to 2 x 0.5 mm galvanised iron wires
- safe voltage transfer to the animal thanks to external metal wires throughout



3-year UV stability warranty



Ref. no.	Length	Colour	max. recommended fence length	Resistance	Number of Conductors	Galvanised Iron Wire	Break Load			€
445025	500 m	transparent	6 km	0.35 Ω/m	2	0,5 mm	50 kg	1/8	200	
445035	1,000 m	transparent	6 km	0.35 Ω/m	2	0,5 mm	50 kg	1/2	120	

## Monowire EconomyLine

- 2 hot galvanised steel wires of 0.50 mm wrapped around 1 nylon core of 1.40 mm
- very good conductivity



3-year UV stability warranty



Ref. no.	Length	Colour	max. recommended fence length	Resistance	Number of Conductors	Galvanised Iron Wire	Break Load			€
44502	500 m	transparent	6 km	0.35 Ω/m	2	0,5 mm	45 kg	1/6	144	
44503	1,000 m	transparent	6 km	0.35 Ω/m	2	0,5 mm	45 kg	1/2	120	

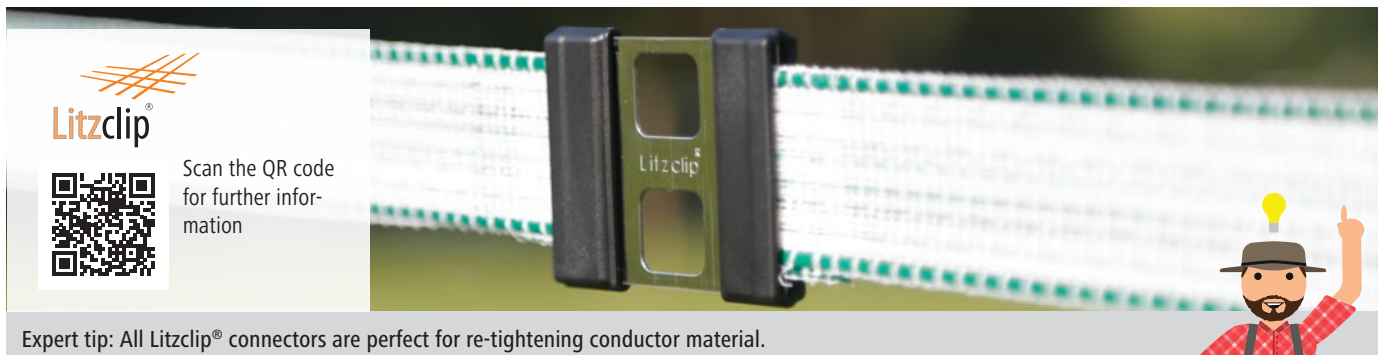

Expert tip: All Litzclip® connectors are perfect for re-tightening conductor material.

This is how it works:

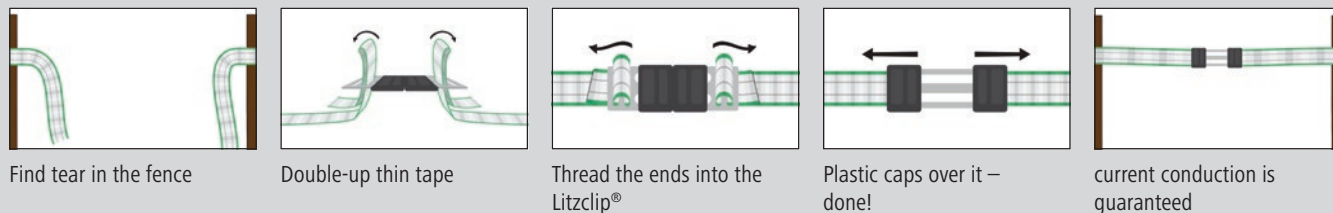

## Tape Connectors Litzclip®

- easy connection of 2 tape ends
- the quick solution for repairing torn fence tapes
- special narrow, punched rectangular openings for the easy introduction and securing of the tape

Made in Germany



patented

Ref. no.	Material	can be used for	MOQ	Pieces / unit		€
442000/051	Stainless Steel	tape up to 12.5 mm	1 pack	5 / pack	1/100	
442001/051	Stainless Steel	tape up to 20 mm	1 pack	5 / pack	1/100	
442002/051	Stainless Steel	tape up to 40 mm	1 pack	5 / pack	1/100	

## Tape Connectors

Stainless Steel



Ref. no.	Material	can be used for	MOQ	Pieces / unit		€
44594	Stainless Steel	tape up to 13 mm	1 pack	10 / pack	1/10/4000	
44595	Stainless Steel	tape up to 20 mm	1 pack	10 / pack	1/10/5000	
44596	Stainless Steel	tape up to 40 mm	1 pack	10 / pack	1/10/1250	



## Tape Connectors

galvanised



Ref. no.	Material	can be used for	MOQ	Pieces / unit		€
44570	steel, galvanised	tape up to 13 mm	1 pack	10 / pack	1/10/4000	
44573	steel, galvanised	tape up to 20 mm	1 pack	10 / pack	1/10/5000	
44573/056	steel, galvanised	tape up to 20 mm	1 pack	5 / pack	1	
44572	steel, galvanised	tape up to 40 mm	1 pack	10 / pack	1/10/1400	
44572/056	steel, galvanised	tape up to 40 mm	1 pack	5 / pack	1/5	





Expert tip: All Litzclip® connectors are perfect for re-tightening conductor material.

## Rope Connector Litzclip®

- ideal for connecting 2 rope ends of up to 6 mm in diameter
- the quick solution for repairing a torn fence rope
- special key-shaped punched opening for the easy introduction and secure fixing of the rope



Made in Germany



patented



Ref. no.	Material	can be used for	MOQ	Pieces / unit		€
442004/051	Stainless Steel	rope up to Ø 6 mm	1 pack	5 / pack	1/100	

## Safety Link for Electric Rope Litzclip®

Electric rope opens at the rope break point in panic situations, reducing the risk of injury to your horse!



Made in Germany



**IMPORTANT:** Reduced risk of injury for your horse, and also reduced pulling force on the rope!



Included in Delivery: 6 x Safety Link, 6 x Replacement Security Buttons

Ref. no.	Material	can be used for	MOQ	Pieces / unit		€
442008/061	Stainless Steel	rope up to Ø 6 mm	1 pack	6 / pack	1/100	

Ref. no.	Description	Colour	Material	MOQ	Pieces / unit		€
442009/066	Replacement Security Buttons	black	Plastic	1 pack	12 / pack	1/100	

## Poly Wire Connector Litzclip®

- the straightforward solution, even for repairing a torn poly wire
- special key-shaped punched opening for the easy introduction and secure fixing of the poly wire



Made in Germany



patented



Ref. no.	Material	can be used for	MOQ	Pieces / unit		€
442003/101	Stainless Steel	poly wire up to Ø 3 mm	1 pack	10 / pack	1/100	

# Rope and Poly Wire Connector

## Rope Connector

Stainless Steel

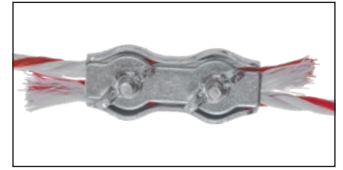

NEW: now with wing nuts

Ref. no.	Material	can be used for	MOQ	Pieces / unit		€
44540	Stainless Steel	Rope 4/6/8 mm	1 pouch	10 / pouch	1/10/100	
44540/051	Stainless Steel	Rope 4/6/8 mm	1 pack	5 / pack	1/50	

## Rope Connector

galvanised



NEW: now with wing nuts

Ref. no.	Material	can be used for	MOQ	Pieces / unit		€
44535	galvanised metal	Rope 4/6/8 mm	1 pouch	10 / pouch	1/10/300	
44535/051	galvanised metal	Rope 4/6/8 mm	1 pack	5 / pack	1	

## Rope Connector

galvanised



- safe mechanical and electrical connection
- easy installation as no tools are required thanks to the wing nut



Ref. no.	Material	can be used for	MOQ	Pieces / unit		€
442354	galvanised metal	Rope 4/6/8 mm	1 pouch	10 / pouch	1/10/600	

## Rope and Poly Wire Connector

- safe mechanical and electrical connection
- easy to mount with a Philips screwdriver

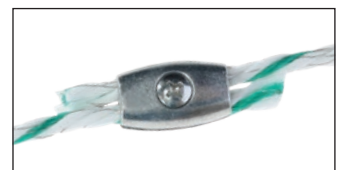

Ref. no.	Material	can be used for	MOQ	Pieces / unit		€
441561	galvanised metal	poly wire up to Ø 2.5 mm	1 pouch	10 / pouch	1/10/100/1200	
441561/051	galvanised metal	poly wire up to Ø 2.5 mm	1 pack	5 / pack	1	
441560	galvanised metal	rope up to Ø 6.5 mm	1 pouch	10 / pouch	1/10/100/600	
441560/051	galvanised metal	rope up to Ø 6.5 mm	1 pack	5 / pack	1	



## Quick Rope/Poly Wire Connector

- allows ropes, wires and tapes of up to 10 mm to be connected to gate insulators and handles quickly and easily, resulting in a connection with optimal electrical conductivity
- made from stainless steel, guaranteeing excellent corrosion resistance
- can be mounted without tools



For secure fixing of stranded wires, we recommend wrapping the conductor material around the screw several times to prevent it from slipping

out.

patented  
Stainless Steel

The benefits: No need for tools, easy to create an optimum electrical connection using fixing screws. Also ideally suitable for retightening.



Ref. no.	Material	can be used for	MOQ	Pieces / unit		€
441285/041	Stainless Steel	Poly Wire, rope up to Ø 8 mm, tape up to 10 mm	1 pack	4 / pack	1	

## Quick Rope/Poly Wire Connector

- allows ropes, wires and tapes of up to 10 mm to be connected to gate insulators and handles quickly and easily, resulting in a connection with optimal electrical conductivity
- can be mounted without tools



For secure fixing of stranded wires, we recommend wrapping the conductor material around the screw several times to prevent it from slipping out.

patented

The benefits: No need for tools, easy to create an optimum electrical connection using fixing screws. Also ideally suitable for retightening.

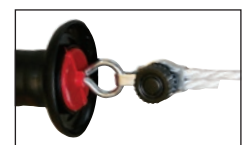

Ref. no.	Material	can be used for	MOQ	Pieces / unit		€
441209/041	galvanised metal	Poly Wire, rope up to Ø 8 mm, tape up to 10 mm	1 pack	4 / pack	1	

# Permanent Fencing Accessories



Stationary fences are also characterised as permanent fencing and are used for several years as reliable security for your animals. This type of fence is especially low-maintenance because of the long-lasting and robust materials used in the construction of permanent fencing.

They are frequently built with recycled posts, metal T-posts and solid wood posts that are anchored deep into the ground. A stable construction is required, especially in corners and junctions, because of the high tensile forces on the material. Mobile fence variants also have their own conductor material. Here we recommend using our Premium Horse Wire (44873) or Special Steel Wire for fixed fences (445055). We have also developed practical de-tensioning and corner solution sets that make the construction of a stationary fence so much easier.

**Der Festzaun-Ratgeber für die Pferdekoppel**  
... Tipps und Tricks zum Selberbauen!



**Fixed fence guide**

Browse the new AKO fixed fence guide online or request your free copy by e-mail at [info@kerbl.com](mailto:info@kerbl.com)!





## Porcelain Corner Insulators

- professional corner insulator made of porcelain
- for high demands
- withstands extreme tensile loads
- for hanging
- Length: 42 mm





Ref. no.	Colour	MOQ	Pieces / unit		€
442362	white	1 box	10 / box	1/10/200	
442362/061	white	1 pack	6 / pack	1	

## Porcelain Corner Insulators

incl. wire rope with eyelet in set of 3

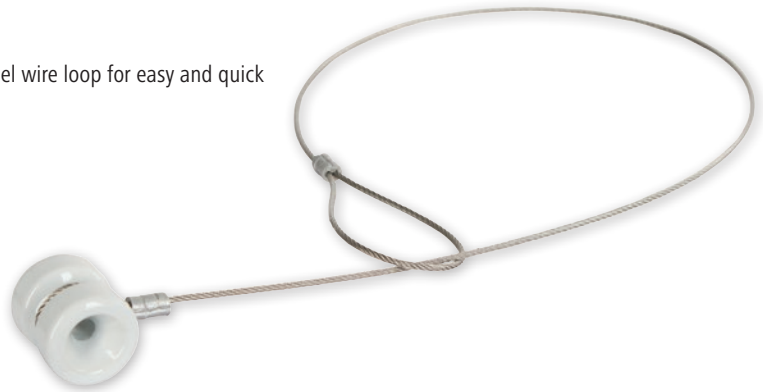
- user-friendly corner solution for all types of fence wire
- professional corner insulator made from porcelain incl. stainless steel wire loop for easy and quick installation on the corner post
- withstands extreme tensile loads
- suitable for corner posts with a diameter of up to 160 mm
- for hanging



Ref. no.	Colour		€
446504	white	1/20	

## Porcelain Strain Insulator

- extremely durable starting and end insulator for fence wires
- withstands extreme tensile loads
- for hanging
- Material: Porcelain
- 10-year warranty

10-year warranty





Ref. no.	Colour	MOQ	Pieces / unit		€
442363	white	1 box	10 / box	1/10/100	



## Fence Wire ALU GUARD

- excellent conductivity, 4 times higher than conventional steel wire
- easy to handle during installation
- low weight (by 2/3 less than steel wire)
- increased breaking load through the addition of magnesium
- Material: Aluminium



Ref. no.	Length	Description	Ø	Resistance	Break Load			€
445002	400 m	on a coil	1.6 mm	0.03 Ω/m	70 kg	1/4	168	
445007	400 m	on a coil	1.8 mm	0.023 Ω/m	90 kg	1/4	168	
445003	400 m	on a coil	2 mm	0.02 Ω/m	110 kg	1/4	120	

## Stranded Wire

- 7 strands
- increased breaking load through the addition of magnesium
- extremely flexible and light, therefore simpler and quicker to set up
- excellent conductivity, 4 times higher than conventional steel wire
- Material: Aluminium





Ref. no.	Length	Description	Ø	Resistance	Break Load			€
445038	500 m	on a coil	1.8 mm	0.027 Ω/m	95 kg	1/4	120	

## Stranded Wire

- 7 strands
- very flexible, easy to install
- multi-use, e.g. for wildlife control
- Material: galvanised iron





Ref. no.	Length	Description	Ø	Resistance	Break Load			€
44500	200 m	no reel	1.5 mm	0.12 Ω/m	200 kg	1	360	
445009	1,000 m	on a coil	1,5 mm	0.12 Ω/m	200 kg	1	60	

## Special Steel Wire for Fixed Fence

- zinc-aluminium-magnesium alloy as long-term protection
- ninefold protection against corrosion compared to galvanized wire
- extremely good conductivity
- ideal for permanent fence installations
- optimum current output upon animal contact
- Material: steel with zinc/aluminium/magnesium alloy
- 10-year warranty

10-year warranty 





Ref. no.	Length	Beschreibung	Ø	Resistance	Break Load			€
445055	1,000 m	no reel	2 mm	0.06 Ω/m	345 kg	1	40	
44505	625 m	no reel	2.5 mm	0.035 Ω/m	650 kg	1	40	

## Iron Wire

- very good conductivity
- proven in fence construction for decades
- optimum current output upon animal contact
- Material: galvanised iron



Ref. no.	Length	Description	Ø	Resistance	Break Load			€
445041	322 m	no reel	1.6 mm	0.07 Ω/m	95 kg	1/5	100	
44504	250 m	no reel	1.8 mm	0.05 Ω/m	110 kg	1/5	100	
445042	200 m	no reel	2 mm	0.04 Ω/m	140 kg	1/5	100	

## Wire Dispenser Vario

- trouble-free unrolling of permanent fencing wire
- robust square pipe design
- suitable for all wire coils or spools with an inner diameter of 30 - 85 cm
- steplessly adjustable
- easy tool-free assembly and disassembly, collapsible for transport
- additional ground plate prevents the wire dispenser sinking into soft ground

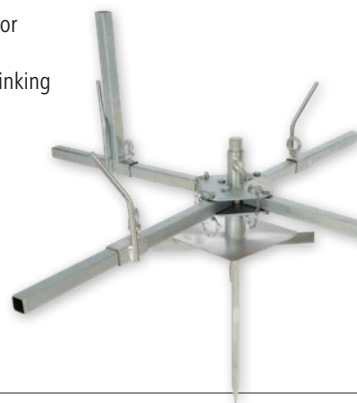

Ref. no.		€
442372	1	

## Wire Dispenser

- trouble-free unrolling of permanent fencing wire
- also suitable for Premium Horse Wire
- for floor mounting

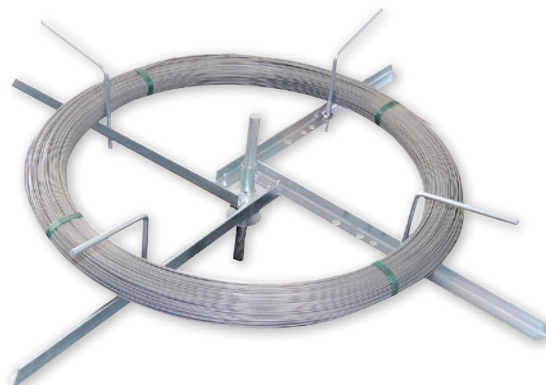

Ref. no.		€
441875	1/3	

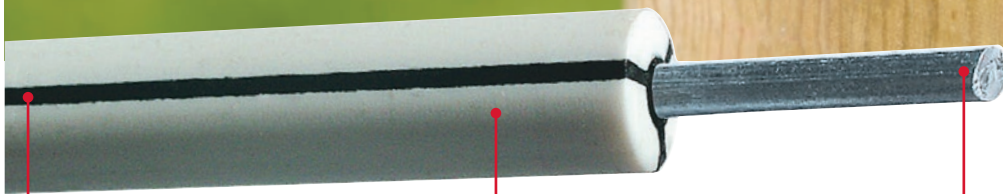

**Electrically conductive plastic**  
The steel wire is enclosed by a layer of electrically conductive carbon fibre plastic mix that reaches up to the surface through three lines.

**Polyethylene polymer**  
The area between the conductive material is surrounded by a sheath of white UV-stabilised polyethylene.

**Steel Wire**  
inside there is a special steel wire of 2.5 mm thickness

## Premium Horse Wire

Our most durable electrifiable horse fencing system! Premium Horse Wire provides a very strong mechanical barrier thanks to the 2.5 mm thick steel wire. The electrically conductive white/black plastic protects the interior steel wire from the weather and resists a breaking load of up to 800 kg. Its round shape and smooth surface mean cuts from the conductor material are avoided.

- great conductivity 0.035 Ohm/m
- high mechanical barrier due to steel wire (breaking strength 800 kg)
- electrifiable and very safe
- extremely weather-proof (cold, warmth, moisture)
- very good visibility due to high proportion of white and 8 mm diameter
- UV-stabilised PE covering
- lower physical hazard for horses due to round and smooth surface



Tip: Use our 'Wire LINK' (442367) for connection



Ref. no.	Length	Ø	max. recommended fence length	Resistance	Break Load			€
44873	250 m	8 mm	57 km	0.035 Ω/m	800 kg	1	20	

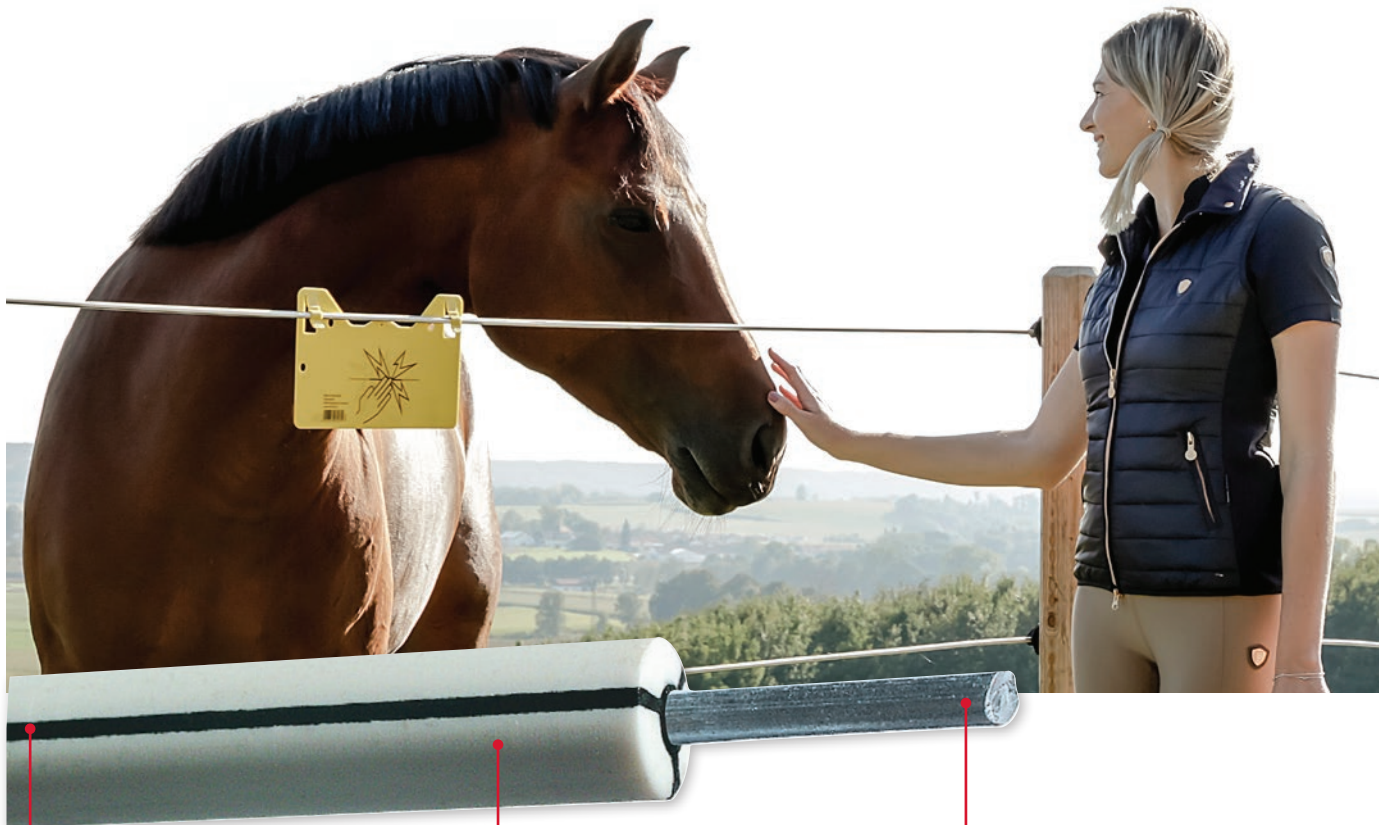

#### electrically conductive plastic

The iron wire is enclosed by a layer of electrically conductive carbon fibre plastic mix that reaches up to the surface through three lines.

#### Polyethylene polymer

The area between the conductive material is surrounded by a sheath of white UV-stabilised polyethylene.

#### Iron Wire

inside there is a galvanised iron wire of 2 mm thickness

## TopLine Horse Wire

Our proven electrifiable horse fencing system is now also available in a reduced diameter version. In the consistent ongoing development of our Premium Horse Wire, we focussed on the ease of applying the fence system while retaining the high quality materials and workmanship.

- low resistance of 0.055 ohms/m, meaning very high conductivity through 2 mm galvanised iron wire
- the reduced diameter of case and wire makes the product softer and more flexible, thus easier to work with
- extremely weather-resistant and durable
- lower physical hazard for horses due to round and smooth surface





5-year warranty

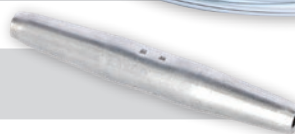

the innovation in fixed fencing – ideal for horse pastures

Tip: Use our 'Wire LINK' (442367) for connection



Ref. no.	Length	Ø	max. recommended fence length	Resistance	Break Load	 	€
442390	200 m	6 mm	36 km	0.055 Ω/m	400 kg	1 25	

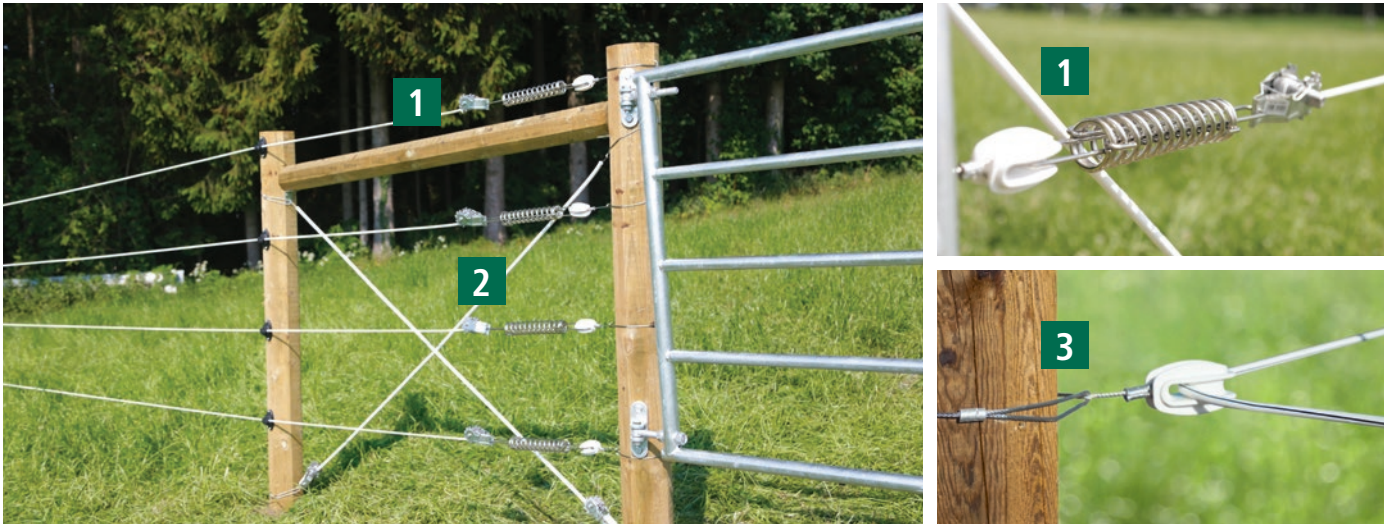

## De-tensioning Set „Horizontal“

- for tensioning posts with a diameter of up to 160 mm

Set includes: 1 x insulation (polyamide), 1 x stainless steel temperature equalisation spring, 1 x permanent wire tensioner (without clamping lever), 1 x stainless steel wire rope loop for fast and easy attachment to the tension post



Ref. no.	can be used for		€
446509	Steel Wire, Premium Horse Wire, TopLine Horse Wire	1	

Ref. no.	Description	Colour	Length	MOQ	Pieces / unit		€
446506	Protective Hose for Temperature Equalisation Spring	black	50 cm	1 pack	3 / pack	1/10	

## De-tensioning Set „Diagonal“

Set for the diagonal de-tensioning of an H post design in the corner and at the fence start and/or end for very high tensile forces of the conductor material.

Set includes: 1 x hose insulator, 1 x stainless steel wire rope loop, 1 x permanent wire tensioner (without clamping lever), 2 x 90° metal brackets and wood screws



Ref. no.	can be used for		€
446508	Steel Wire, Premium Horse Wire, TopLine Horse Wire	1/10	

## Corner Solution for Fixed Fences

- Polyamide de-tensioning isolator with stainless steel wire loop for fast and easy attachment to the tension post
- for corner posts with a diameter of up to 160 mm

- 1 pack contains: 3 x stainless steel wire loop for fast and easy attachment to the tension post, 3 x de-tensioning insulator (polyamide)





Ref. no.	MOQ	Pieces / unit		€
446507	1 pack	3 / pack	1/20	

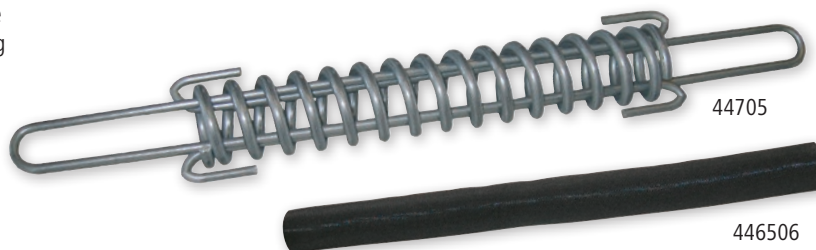

## Temperature Equalisation Spring

- stable design for steel wire
- eases strain on wire and corner posts
- balances temperature variations and renders the fence flexible
- protective tube prevents horse hair being trapped in the spring



Ref. no.	Length	Ø	Material	can be used for		€
44704	43.5 cm	43 mm	galvanised metal	steel wire 2.5 mm	1/20	
44705	43.5 cm	43 mm	Stainless Steel	steel wire 2.5 mm	1/20	
44259	20 cm	25 mm	Stainless Steel	steel wire 1.6 mm	1/60	

Ref. no.	Description	Colour	Length	MOQ	Pieces / unit		€
446506	Protective Hose for Temperature Equalisation Spring	black	50 cm	1 pack	3 / pack	1/10	

## Gear-Toothed Wire Tensioner

- tightens/loosens rapidly wires, ropes and poly wires
- with cliplock



Ref. no.	Description	Material		€
44509	single	Metal	1/50	
441327	with integrated insulator	Metal	1/20	
441297	with integrated insulator and wire rope	Metal	1/10	

Ref. no.	Description		€
441328	Clamping Lever for Gear-toothed Wire Tensioner	1/20	



## Fin Tube Insulator

- polyethylene pipe as insulation corner solution in the permanent fence
- nail on with staples 44394 (not included)
- suitable for: rope up to Ø 8 mm, Premium Horse Wire, TopLine Horse Wire

Ref. no.	Colour	Length	Ø	MOQ	Pieces / unit		€
44392	white	60 cm	8 mm	1 pouch	10 / pouch	1/10	13,99

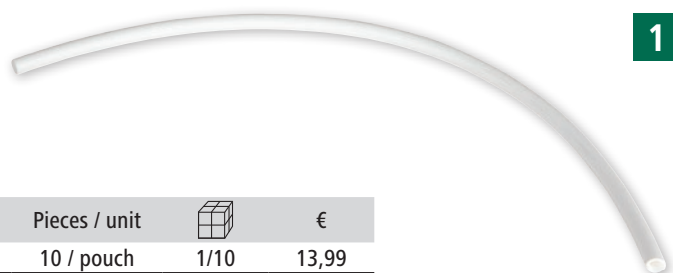

## Staples

- Material: galvanised metal

Ref. no.	Length	Width	MOQ	Pieces / unit		€
44394	47 mm	3.8 mm	1 pouch	50 / pouch	1/20	



## Wire Tensioner

- rotatable
- tightens/loosens rapidly wires, ropes and poly wires without cutting them in two

Ref. no.	Material	MOQ	Pieces / unit		€
44513	Metal	1 pack	1 / pack	1/32	
44513/031	Metal	1 pack	3 / pack	1/50	

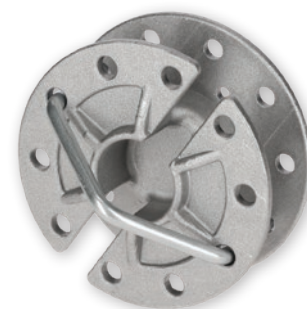

## Tensioning Arm for Wire Tensioner

- Material: galvanised metal

Ref. no.		€
44514	1/20	



## Chain Tensioner

- ideally suited for tensioning all kinds of electric fence wire
- two-piece
- Material: Metal

Ref. no.		€
441269	1/3	

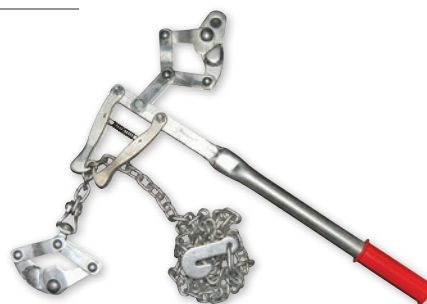

## Farming Forceps Standard

- cuts wire up to Ø 5 mm
- essential for fence construction
- can also be used as a hammer

Ref. no.	Colour		€
28255/1	black	1/6/36	



## Wire Connectors Wire Link

Sturdy wire connector allows the connection of two wires without tools. The wire is simply pushed into the opening and cannot free itself without intervention.

Expertentipp: keine Verletzungsgefahr durch überstehende Drahtenden - ideal für Pferdeweiden mit Premium Horse Wire bzw. TopLine Horse Wire



Ref. no.	Material	can be used for	MOQ	Pieces / unit		€
442367	Aluminium	steel wire 1.8 - 2.5 mm, Premium Horse Wire, TopLine Horse Wire	1 pouch	2 / pouch	1/200	

## Wire Connecting Clamp

- for the safe, vertical connection of fixed fence wire series and/or the underground cable with the fence wire

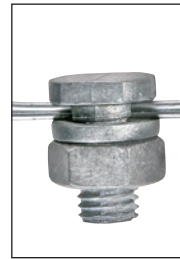

Ref. no.	Material	can be used for	MOQ	Pieces / unit		€
441225	galvanised metal	steel wire up to 2.5 mm, Premium Horse Wire, TopLine Horse Wire	1 pouch	10 / pouch	1/10/500	
441225/041	galvanised metal	steel wire up to 2.5 mm, Premium Horse Wire, TopLine Horse Wire	1 pack	4 / pack	1/50	

## Wire Connecting Clamp

- suitable for the electrical cross-connection of multiple wires
- also ideal as a connection from fence feeder to wire

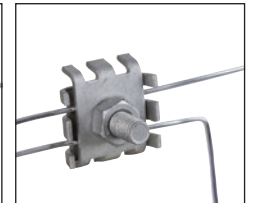
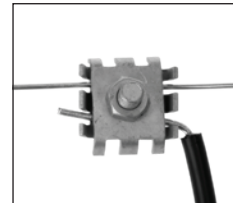

Ref. no.	Material	can be used for	MOQ	Pieces / unit		€
442364	galvanised metal	steel wire up to 2.5 mm	1 pouch	10 / pouch	1/10/400	

## Gripple Wire Connectors

**GRIPPLE**

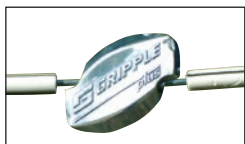

44706-0

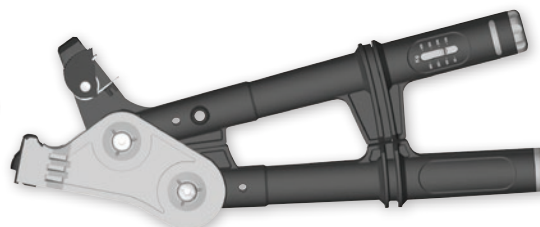

Ref. no.	can be used for	Operating Load	MOQ	Pieces / unit		€
44707	steel wire 1.4 - 2.2 mm	220 kg	1 pack	20 / pack	1/20/300	
44706	steel wire 2.0 - 3.25 mm	400 kg	1 pack	20 / pack	1/20/200	
44706/066	steel wire 2.0 - 3.25 mm	400 kg	1 pack	6 / pack	1	
44706-0	steel wire 2.0 - 3.25 mm	400 kg	400 pieces	400 / bucket	1/400	

Ref. no.	Description		€
44703	Collet Chuck with Tension Control	1/4	

# Permanent Fencing Accessories

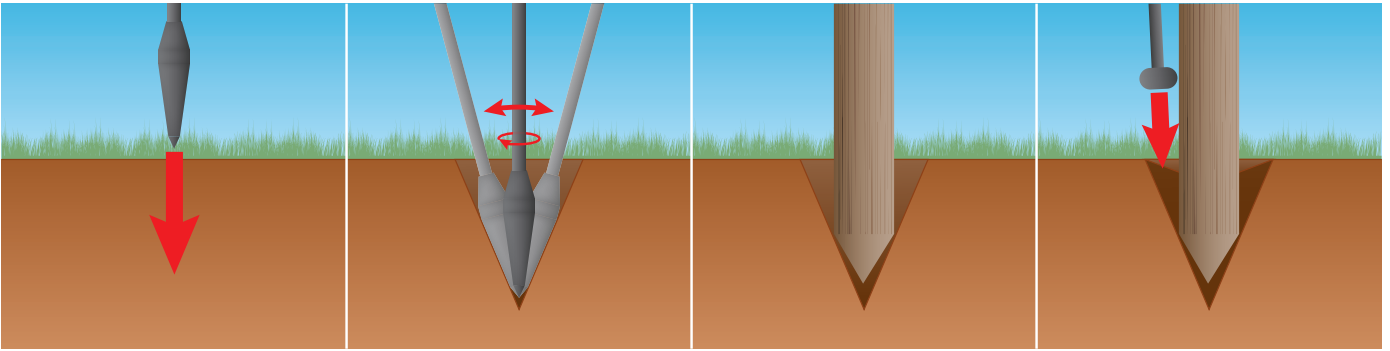

## Stake Iron

- for piercing the ground for large fence posts (wooden stakes, etc.)
- made from hardened, round, powder-coated silicone spring steel
- with round tip and rounded steel pommel for the hand
- the upper knob at the start of the post also serves to press down the soil after driving in the post, compact it and ensure a stable grip

Made in Germany





Ref. no.	Colour	Length	Weight approx.			€
441425	black	130 cm	7 kg	1	100	

## Post Hole Digger

- the ideal aid for fence building
- fatigueless drilling before posts are set up
- with T-handle



Ref. no.	Material	Ø			€
44484	steel, lacquered	80 mm	1	50	
44485	steel, lacquered	90 mm	1	50	
44486	steel, lacquered	150 mm	1	30	



## Wooden Mallet

- incl. welded scorper



Ref. no.	Material	Length	Width	Weight		€
44482	Ash	93 cm	23 cm	6 kg	1	

Ref. no.	Description	Material	Length		€
44483	Handle for Wooden Mallet	Ash	95 cm	1/10	

## Sledge Hammer

- hammer head made from break-proof plastic
- hickory handle



Ref. no.	Colour	Weight		€
441422	black	5 kg	1	

## Hand Pile Driver

- for hammering in pasture fence posts up to Ø 100 mm

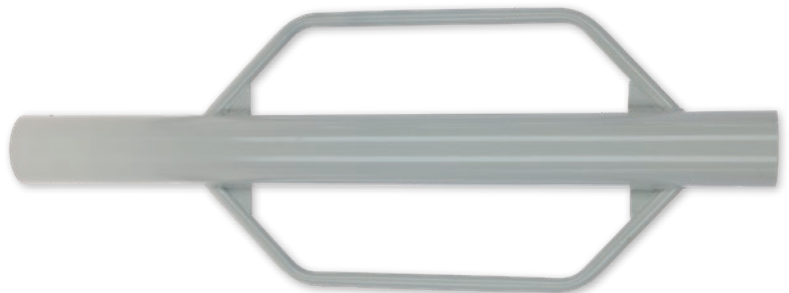

Ref. no.	Material	Diameter	Interior diameter	Weight		€
44471	Metal	114 mm	108 mm	12 kg	1	

## Robinia post

---



# Wooden Posts for Permanent Fencing

## Robinia post

- Robinia wood, often also known as false acacia, is one of the European hard woods
- renowned for its exceptional durability and resilience against weather and rot, even when in constant contact with water and soil
- since no additional impregnation is required, this is an especially environmentally friendly solution
- the post wood adapts dynamically to changing environmental conditions
- during periods of high humidity, it absorbs water and expands, releasing moisture and contracting when the environment is dry. These natural processes can lead to cracks in the post, however they do not impair the post's stability or lifespan
- fresh Robinia posts initially have a yellow-green appearance that develops into an attractive silver-grey patina through the influence of UV radiation and moisture. This is characteristic, protecting the wood and giving it an attractive appearance
- the posts are easy to install and can be rammed or buried into the ground without problem, making installation efficient and time-saving
- the post is perfectly and evenly protected - without any gaps - against insects, fungi and mould rot thanks to its natural properties
- 10-year warranty

New product

NEW

10-year warranty

10

Made in the EU



All posts are debarked, pointed on 4 sides and bevelled.

Bark is not suitable for horses, so sanded posts are preferable for horse fences.

The product is subject to natural variations in shape and form which do not constitute grounds for complaint. The diameter specified is measured in the centre of the post.

Ref. no.	Description	Total Height	Post Ø		€	
442420	Track post, round	150 cm	6 - 8 cm	1	150	
442427	Track post halved, round	200 cm	13 - 15 cm	1	100	
442425	Curved post, round	200 cm	10 - 12 cm	1	70	
442426	Curved post, round	250 cm	10 - 12 cm	1	70	
442421	Corner post, round	250 cm	14 - 16 cm	1	30	
442422	Corner post sanded, round	270 cm	16 - 18 cm	1	25	

Freight prices on request!

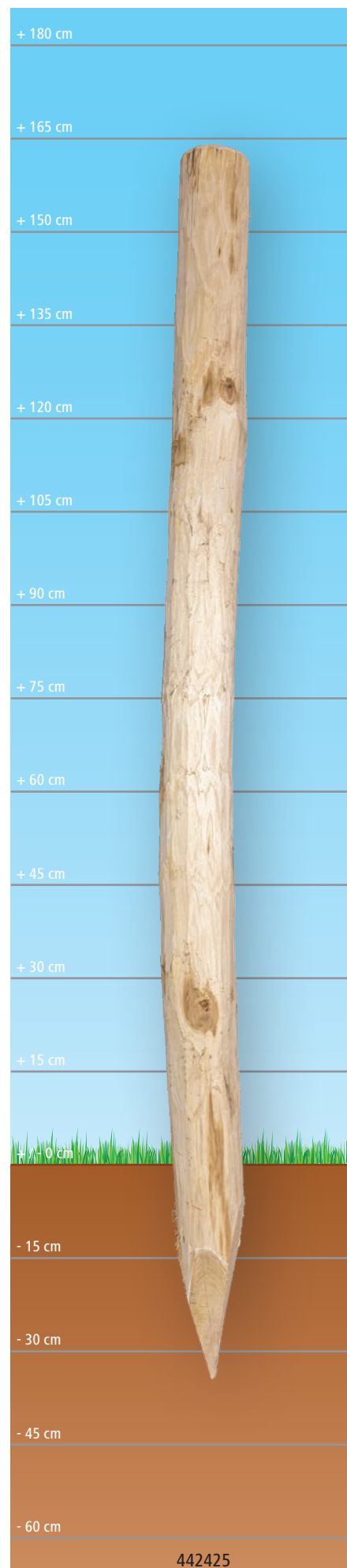

# Octo Wood



## Raw materials

OctoWood uses only slow-growing Scandinavian pine grown north of 64 degrees latitude:

- Low temperatures
- Not much daylight
- Smaller tree crowns
- Straight trunk
- High rigidity
- High breaking load

With its 8 sides, the wooden post with ingenious octagonal profile of pine wood (*Pinus Sylvestris*) enables flexibility when fitting insulators. The most commonly used fence post is available in different lengths as well as different diameters, allowing it to be used in any fence system. Pine wood is not a hardwood and is therefore easy to work with.

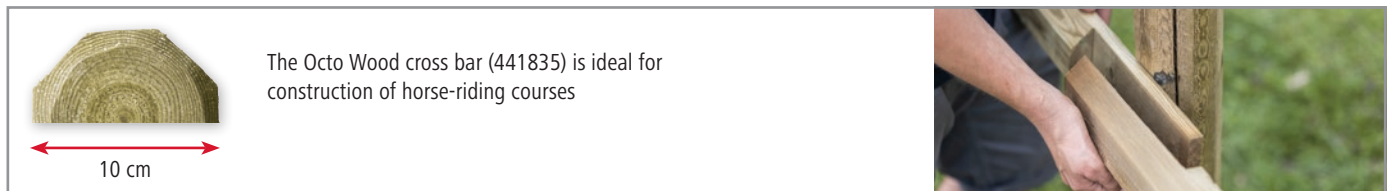
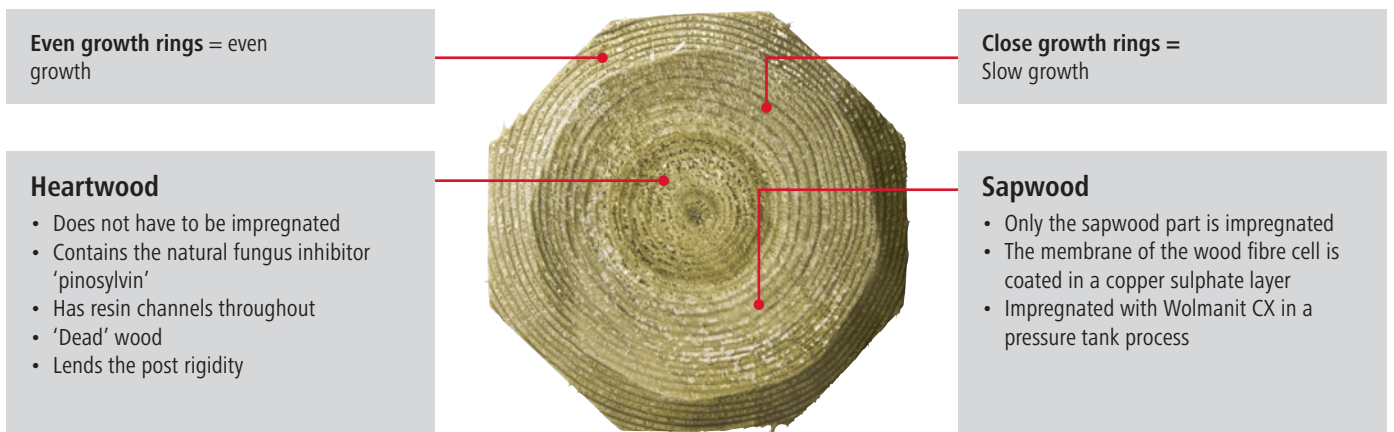

# Wooden Posts for Permanent Fencing

10-year warranty



Made in the EU



## OctoWood

- ingenious octagonal profile made from Pinus silvestris = pine wood
- thanks to straight outer surfaces, the insulators can be assembled particularly easily without any pre-drilling
- the octagonal profile ensures a secure grip on pallets and makes transport easier as it does not roll away
- with highly effective pressure impregnation, therefore ideal for use class 4 (= exposed to constant weathering and ground contact)
- the impregnation effectively protects the wood from moisture, prevents rotting and therefore increases stability and durability
- pressure-impregnated wood requires less maintenance than untreated wood and is less susceptible to warping or shrinkage
- the post is perfectly and evenly protected - without any gaps - against insects, fungi and mould rot
- this post is also well-suited for erecting a wooden fence
- suitable for continuous earth and water contact
- 10-year warranty

ideal for corner, gate, first and last posts

Ref. no.	Description	Total Height	Post Ø			€	
441827	Corner / Gate Post	210 cm	140 mm	1	48		
441828	Corner / Gate Post	250 cm	140 mm	1	48		
441820	Track Post	150 cm	60 mm	1	252		
441821	Track Post	200 cm	60 mm	1	252		
441822	Track Post	180 cm	80 mm	1	154		
441823	Track Post	200 cm	80 mm	1	154		
441825	Track Post	200 cm	100 mm	1	99		
441826	Track Post	225 cm	100 mm	1	99		

Ref. no.	Description	Length		€	
441835	Cross Bar Octo Wood	350 cm	1		



# Recycled Posts

---



Sustainable recycling and the circular economy are omnipresent nowadays and more important than ever in light of dwindling resources. Our recycled posts are therefore made entirely from post-consumer material: the old plastic in the yellow bag is used to create high-quality and robust material which is used as a resource-sparing raw material for our posts. Since production processes must also be taken into account in a meaningfully sustainable circular economy, the entire recycling, reprocessing and production process takes place in Germany. Made in Germany stands not only for top quality but also for short and sustainable paths in the manufacturing process for this environmentally conscious product line.

Made in Germany 







10-year warranty 



- Outstandingly suitable for soft, moist, or deep soils
- Extremely durable
- Optimum handling options (screwing, nailing, sawing, drilling)
- Fully insulated
- Ground water-neutral and rot-proof
- Sharpened at one end
- Ideal as a track post

## Recycling Post round Profile



- drive into the ground about 50 – 60 cm deep
- tried-and-tested round profile
- 10-year warranty

Ref. no.	Total Height	Post Ø			€	
44460	130 cm	45 mm	1	165		
44462	150 cm	50 mm	1	300		
44463	150 cm	60 mm	1	125		
44474	185 cm	60 mm	1	125		
44465	180 cm	75 mm	1	60		
44467	200 cm	75 mm	1	60		
44469	220 cm	100 mm	1	33		

## Recycled Post cross Profile

- very sturdy cross profile
- 10-year warranty







Ref. no.	Total Height	Post Ø			€	
442059	150 cm	70 x 70 mm	1	120		
442043	200 cm	70 x 70 mm	1	120		

## Recycling Post square Profile

- practical square profile
- 10-year warranty



Ref. no.	Total Height	Post Ø			€	
442057	175 cm	70 x 70 mm	1	55		
44478	175 cm	90 x 90 mm	1	45		
44477	200 cm	90 x 90 mm	1	45		

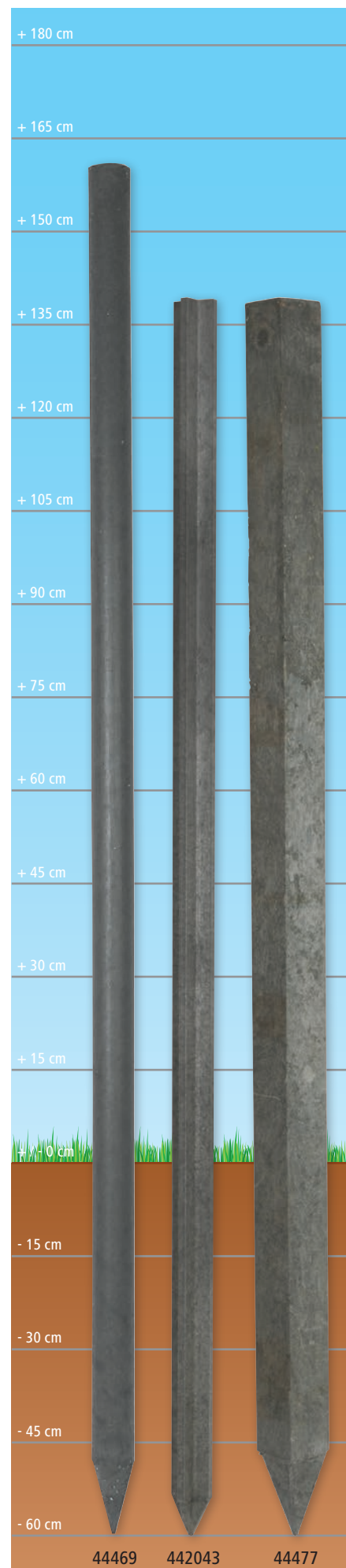



## T-Post and Accessories

### Raw materials

Our T-Post is made from prepared, hot-rolled rail steel, which is one of the strongest and most durable types of steel. Due to its extreme rigidity, this steel will only become minimally deformed even under the highest stress and is therefore the best choice for the construction of semi-permanent fence systems and fixed fences. The typical green paint also protects the stable rail steel of the T-Posts from the influences of weather. The entire post is covered in nubs spaced at intervals of 55 mm to enable the set-up of fences of various heights. This enables the easy attachment of a wide range of insulators for all conductor materials, tool-free and at any height.

T-post profile



### Assembly

The T-post can be installed by just one person with the help of a specially developed pile driver (446540). Here, please bear in mind that the posts must be driven sufficient deep to ensure that the entire 18 cm-long anchor plate (drive-in depth approx. 40 cm) is sunk into the ground.

High-quality, easy-installation T-posts in various lengths for long-term use. The entire post is covered in nubs spaced at intervals of 5.5 cm for attaching accessories. A robust base plate gives the post a secure footing. The paint on the posts guarantees high weather resistance. We recommend using T-posts that are approx. 30 cm longer for each corner. The insulators can be fixed securely at the desired height by clipping them to the T-post.

T-posts are suitable for all types of pasture, as a supplemental fence for rotational grazing, as a semi-permanent paddock fence, and as a way to fence in an outlet.

### Fixed fence guide

Browse the new AKO fixed fence guide online or request your free copy by e-mail at [info@kerbl.com](mailto:info@kerbl.com)!



# T-Post and Accessories

## Metal Post T-Post

- with solid base plate
- drive into the ground about 40 cm
- perfect for horses, cattle and wild animal fences



Ref. no.	Colour	Total Height			€
441460	green / white	152 cm	1/5	200	
441407	green / white	167 cm	1/5	200	
441461	green / white	182 cm	1/5	200	
441462	green / white	213 cm	1/5	200	
441463	green / white	240 cm	1/5	200	

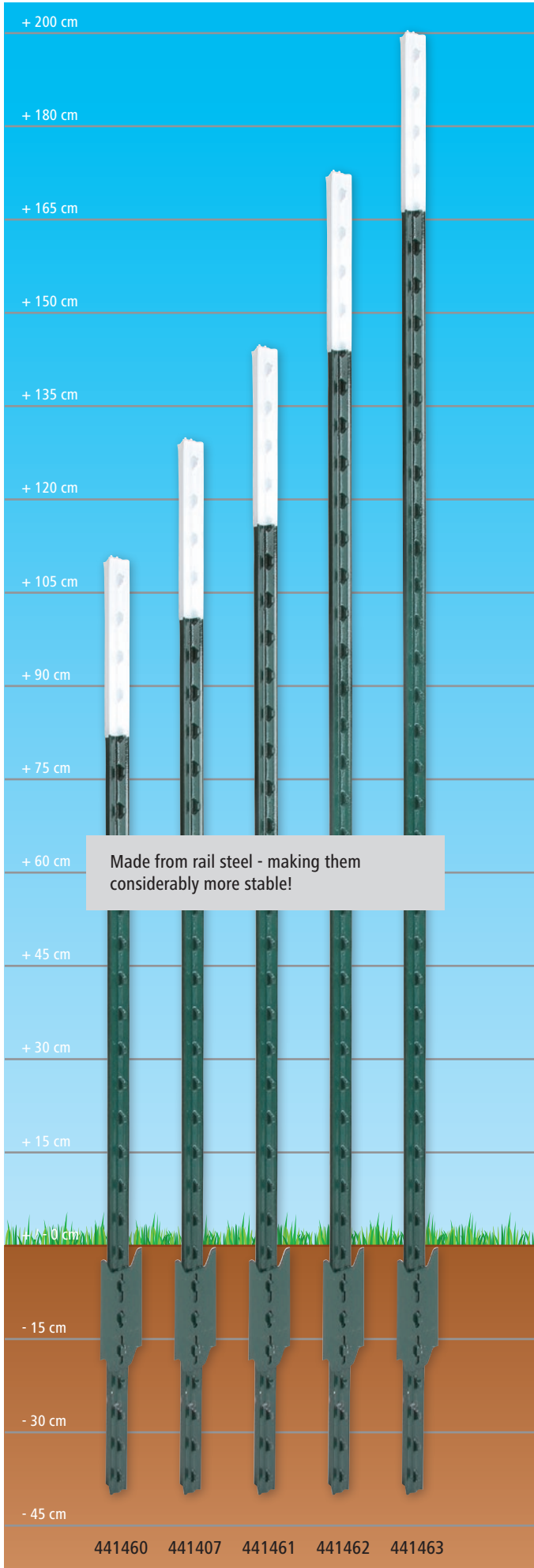



## Fence Starter Set T-Post

The support kit...Installation of a fence starter with T-posts

- Drive the gate or junction post approx. 40 - 50 cm into the ground...
- Drive in the next track post using a spacing of 1.50 m...
- Remove the base plates from the diagonal support post...
- Install the fence starter set on the gate or junction post and on the track post...
- Attach the diagonal support post to the sleeve and align it.

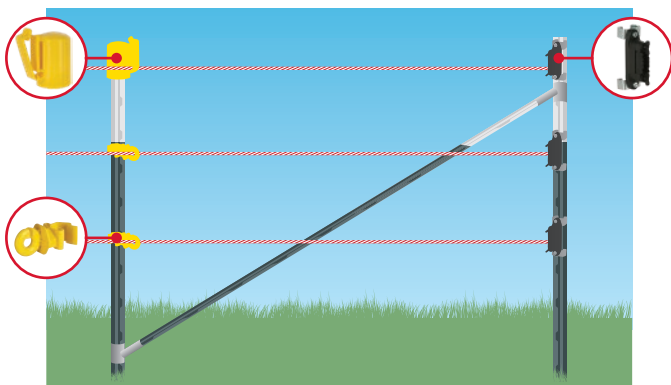

Set includes: 2 x brackets for diagonal strut, incl. fastening screws and protective caps

Ref. no.		€
441178	1/12	

## Variable Corner Solution Set T-Post

The corner in detail...Installation of a corner with T-posts

- Drive the corner post approx. 40 - 50 cm into the ground...
- Drive in both additional corner and stretch posts using a spacing of 1.50 m each...
- Remove the base plates from both diagonal support posts...
- Install the corner solution set on the corner posts...
- Attach the diagonal support posts to the sleeve and align them.

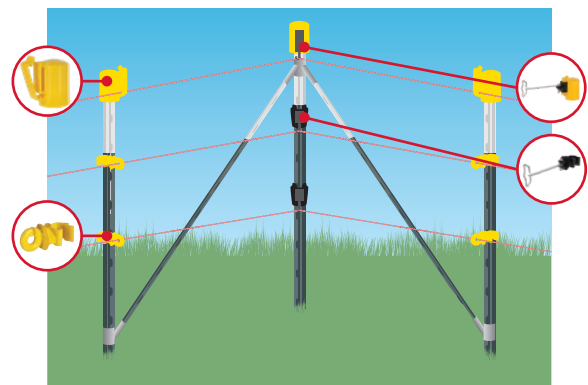

We recommend using our T-Post corner insulators on the corner post to avoid the conductor touching the diagonal support posts.

Set includes: 1 x corner bracket universal, 4 x two brackets for diagonal brace incl. fixing screws and caps, incl. fitting instructions

Ref. no.		€
441177	1/6	

## Head Insulator T-Post

- new design with improved post support
- can be extended with corner solutions for tapes and ropes
- avoids injuries to animals at the post end
- clip-on
- Material: plastic, UV-stabilised
- suitable for: Wire, Poly Wire, Rope, tape up to 40 mm



We always recommend the use of head insulators for T-post fencing systems

Ref. no.	Colour	MOQ	Pieces / unit		€
441252	black	1 pouch	10 / pouch	1/10/200	
441253	yellow	1 pouch	10 / pouch	1/10/200	

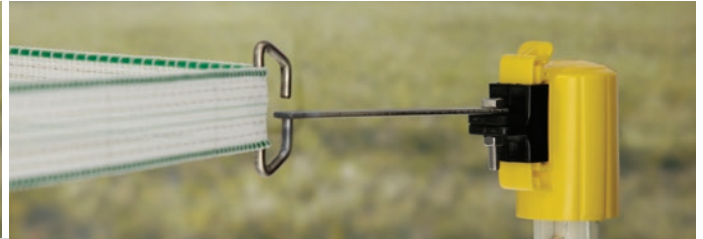
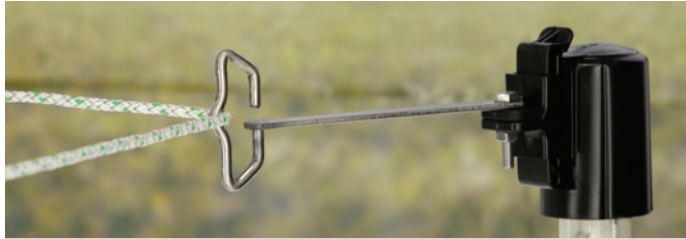

The ideal solution for preventing the conductor material touching the diagonal support posts in the corner structure.

## Head Insulator Tape/Rope Corner Solution T-Post

- the highest quality with a stainless steel frame
- conductor material is protected by rounded edges
- suitable for: Poly Wire, Rope, tape up to 40 mm

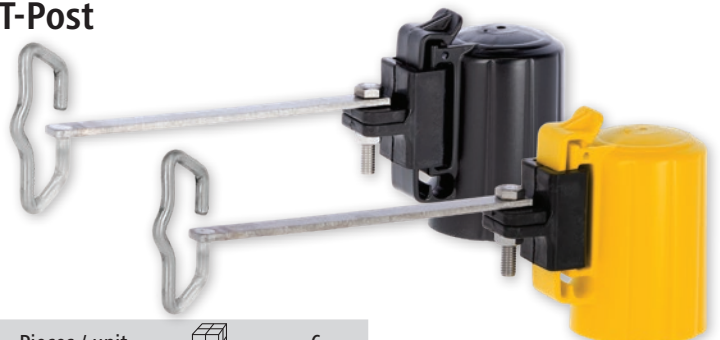

Included in Delivery: 4 x head insulators, 4 x spacers, 4 x clips

Ref. no.	Colour	Support Length	MOQ	Pieces / unit		€
446536	yellow	15 cm	1 pouch	4 / pouch	1/25	
446537	black	15 cm	1 pouch	4 / pouch	1/25	

## Tape Insulator T-Post

- improved clip system - simplifies fastening to the T-post
- Material: Plastic
- suitable for: tape up to 50 mm



Ref. no.	Colour	MOQ	Pieces / unit		€
441183	black	1 pouch	25 / pouch	1/25/200	
441184	yellow	1 pouch	25 / pouch	1/25/200	

## Pinlock Insulator T-Post

- improved clip system - simplifies fastening to the T-post
- Material: Plastic
- suitable for: Rope, Poly Wire, Wire, tape up to 10 mm



Ref. no.	Colour	MOQ	Pieces / unit		€
441186	black	1 pouch	25 / pouch	1/25/200	
441187	yellow	1 pouch	25 / pouch	1/25/200	

## Ring Insulator T-Post

- improved clip system - simplifies fastening to the T-post
- Material: Plastic
- suitable for: Wire, Poly Wire, Rope, tape up to 10 mm

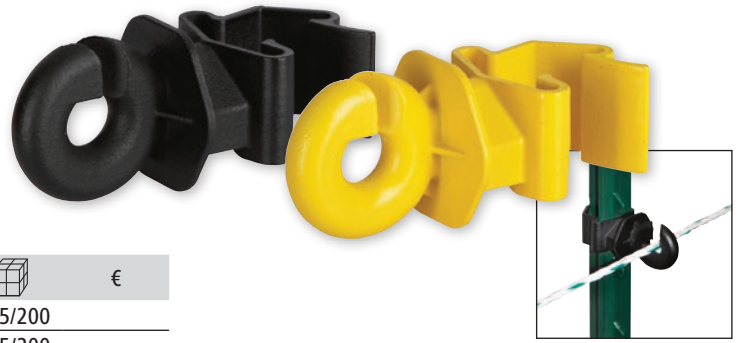

Ref. no.	Colour	MOQ	Pieces / unit		€
441180	black	1 pouch	25 / pouch	1/25/200	
441181	yellow	1 pouch	25 / pouch	1/25/200	

## Rope Insulator T-Post

- extra robust design
- improved clip system - simplifies fastening to the T-post
- Material: Plastic
- suitable for: Wire, Poly Wire, rope up to Ø 8 mm, tape up to 10 mm

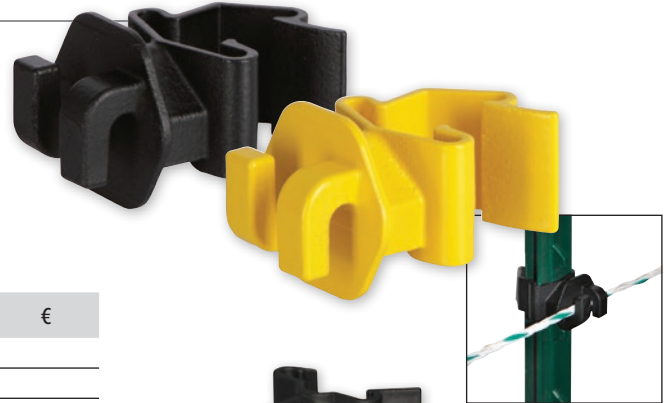

Ref. no.	Colour	MOQ	Pieces / unit		€
441189	black	1 pouch	25 / pouch	1/25/200	
441190	yellow	1 pouch	25 / pouch	1/25/200	

## Distance Insulator T-Post

- distance between wires 12.5 cm
- simplifies fastening to the T-post
- Material: Plastic
- suitable for: Wire, Poly Wire, Rope, tape up to 10 mm

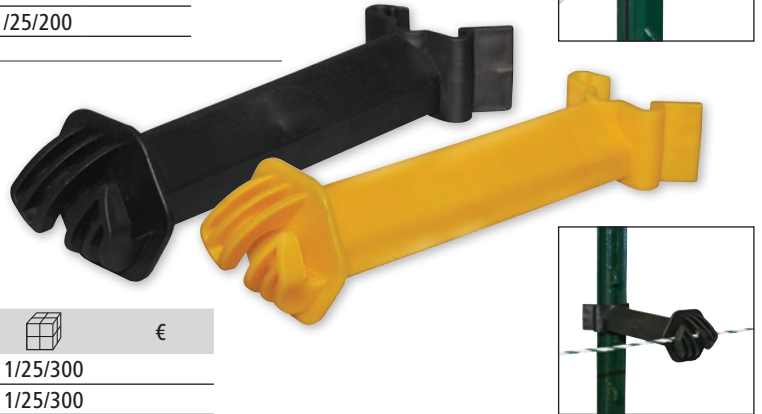

Ref. no.	Colour	MOQ	Pieces / unit		€
442343	black	1 pouch	25 / pouch	1/25/300	
442344	yellow	1 pouch	25 / pouch	1/25/300	

## Rear Side Spacer Insulator T-Post

- easy to attach to the back of the T-Post using the clip system
- enables a second fence line to be drawn on the opposite side to the normal „front“ side
- drawing a second fence line can secure existing fences against intruders such as wolves
- also ideal for separating paddock compartments, as a row of fencing can be erected on both sides of the posts between the compartments
- Material: Plastic
- suitable for: Poly Wire, Rope, tape up to 20 mm



Ref. no.	Colour	Length	MOQ	Pieces / unit		€
442347	black	15 cm	1 pack	25 / pack	1/25/125	
442348	black	7 cm	1 pack	25 / pack	1/25/150	

442347: this insulator allows wolf-detering fence construction with T-posts for horses in accordance with the current VDE standard on herd protection measures

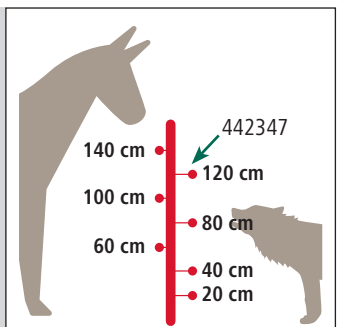

## Tape/Rope Corner Solution T-Post

the ideal solution for T-Post corners for fencing ropes and tapes

- the highest quality with a stainless steel frame
- conductor material is protected by rounded edges
- suitable for: Poly Wire, Rope, tape up to 40 mm



Included in Delivery: 4 x insulators, 4 x spacers

Ref. no.	Support Length	MOQ	Pieces / unit		€
446538	15 cm	1 pack	4 / pack	1	

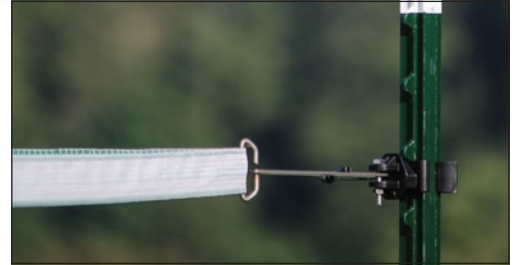

## Gate Insulator T-Post Vario

also ideal for use as a starting insulator  
Stainless steel connecting plate



Set consisting of: 3 x gate insulators, 3 x stainless steel connecting plates each with 3 connection options

Ref. no.	Colour	MOQ	Pieces / unit		€
446516	black	1 pack	3 / pack	1	



## Gate Insulator T-Post

- clip-on with universal clamps



Set consisting of: 4 x gate insulators, 4 x universal clamps

Ref. no.	Colour	MOQ	Pieces / unit		€
441231	black	1 pack	4 / pack	1/50	



## Tape Gate Insulator Set T-Post Premium

- a robust tape insulator with stainless steel connecting plate for gate handle and pasture fence connection
- clip-on with universal clamps
- suitable for: Rope, tape up to 40 mm



also ideal for use as a starting insulator  
Stainless steel connecting plate

Set consisting of: 2 x insulators with stainless steel plate, 4 x T-post Universal Clamp

Ref. no.	Colour	MOQ	Pieces / unit		€
441494	black	1 pair	2 / pack	1	



## Tape, Rope and Corner Insulator T-Post

- clip-on with universal clamps
- suitable for: Poly Wire, Rope, tape up to 40 mm

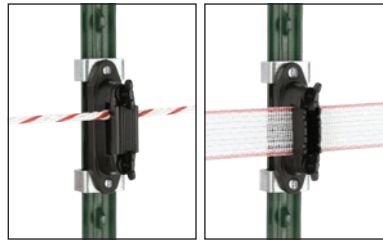

Set consisting of: 4 x prof corner/stretch Insulator, 8 x universal clamps

Ref. no.	Colour	MOQ	Pieces / unit			€
441232	black	1 pack	4 / pack	1	120	

## Rope Corner Insulator T-Post

- clip-on with universal clamps
- suitable for: Poly Wire, Rope, tape up to 10 mm



Set consisting of: 4 x rope insulator, 4 x universal clamps

Ref. no.	Colour	MOQ	Pieces / unit		€
441233	black	1 pack	4 / pack	1/100	

## Corner Insulator Premium

- extra strong finish made from polyamide plastic (PA)
- no slipping of the conductive material on the metal support thanks to the insulator's special shape
- 2 nuts included
- with metric thread
- with continuous galvanised support Ø 8 mm
- suitable for: Rope, Poly Wire, Wire

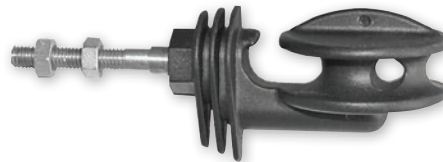

industrial design registered

Ref. no.	Colour	Thread	Thread Length	MOQ	Pieces / unit		€
441360	black	M6	30 mm	1 pouch	10 / pouch	1/10/250	

## Tape Corner Insulator Cavallo

- extra strong finish made from polyamide plastic (PA)
- free-running tape is fed through safely thanks to smooth, rounded surface
- 2 nuts included
- with metric thread
- with continuous galvanised support Ø 8 mm
- suitable for: tape up to 40 mm



Universal clamps (44790) not included.

Ref. no.	Colour	Thread	Thread Length	MOQ	Pieces / unit		€
441377	black	M6	30 mm	1 pouch	10 / pouch	1/10/250	

## Universal Clip Set T-Post

The ideal solution for attaching insulators to the fence start, corner, and gate systems in T-Post systems.

Made in Germany



- simple and quick fixation of wooden screw-in insulators to the T-Post
- insulators are attached to the universal clip by means of screws
- universal clip can be attached or retrofitted to the T-Post quickly at any time, without using a tool, using proven clip system



Set consisting of: 8 x universal clip, 8 x screw

Ref. no.	MOQ	Pieces / unit		€
441176	1 pack	8 / pack	1/50	



## Universal Clamp Set T-Post

- usage on the T-Post enables universal fitting of all insulators with M6 metric thread or with 6 mm diameter hole
- Material: Metal



Set consisting of: 2 x universal clamps, 2 x mounting screws

Ref. no.	MOQ	Pieces / unit		€
44790	1 pouch	2 / pouch	1/2/200	

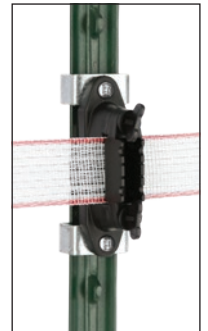

## Fixing Clips for T-posts

- for attaching wire, wild animal fence or knotted mesh to the T-post (cannot be used for electrified wires)
- can be used for all commercially available T-posts
- robust design
- quick and easy installation by placing the clip on the post and then bending the ends over using pliers or a screwdriver
- ideal also for garden and wire mesh fences
- Material: galvanised metal



Ref. no.	MOQ	Pieces / unit		€
441175	1 pack	25 / pack	1/50	



## Ram for T-Post

- makes it easy to drive the t-post into the ground
- extra robust design

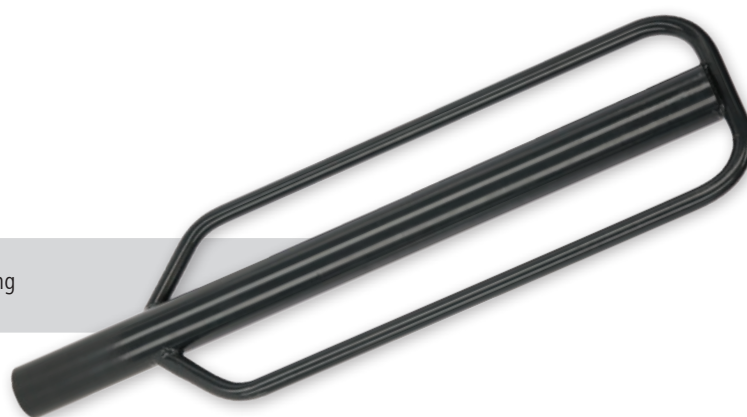

- continuous tubular grip for even more comfortable and safe working

Ref. no.	Colour	Material	Length	Interior diameter	Weight		€
446540	anthracite	metal, varnished	80 cm	5.2 cm	8 kg	1	

## Puller for T-Post

- enables the easy dismantling of your T-post



Ref. no.	Colour	Material		€
441300	red	metal, varnished	1	





## Spring Steel Post Profi

- oval fence post made from high-quality, extra-strong spring steel
- highly visible head insulator is firmly fixed to the post and suitable for wires/ropes up to 6 mm in diameter
- strong, welded tread plate enables quick and easy installation
- ideal for fencing in dairy cows and cattle
- extremely robust and resilient

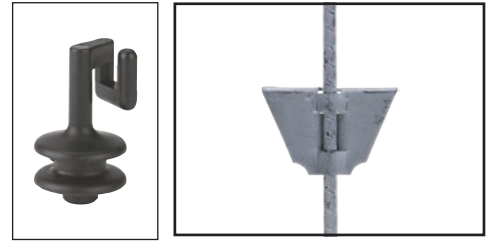

Ref. no.	Description	Colour	Total Height	Post Ø	Length Ground Nail	Material Ground Nail	MOQ	Pieces / unit			€
441475	oval	silver	107 cm	11 x 7 mm	20 cm	Metal	3 pack	30 / box	1/10/30	720	<b>NEW</b>
441403	oval	silver	108 cm	11 x 7 mm	20 cm	Metal	3 pack	30 / box	1/10/30	720	

Ref. no.	Description	Colour	Material	MOQ	Pieces / unit		€
4413151	Spare Insulator for Oval Steel Post	black	Plastic	1 pouch	25 / pouch	1/25/400	
4413170/25	Spare Insulator for oval Steel Post	yellow	Plastic	1 pack	25 / pack	1/20	

## Spring Steel Post

- with large top insulator
- with tread plate



posts for the cattle husbandry, proven for decades

Ref. no.	Description	Colour	Total Height	Post Ø	Length Ground Nail	Material Ground Nail	MOQ	Pieces / unit			€
441458	round	brown	107 cm	8 mm	20 cm	Metal	3 pack	10 / pack	1/10/30	720	
441457	oval	brown	107 cm	11 x 5 mm	20 cm	Metal	3 pack	10 / pack	1/10/30	720	
441455	oval	brown	106 cm	11 x 5 mm	20 cm	Metal	3 pack	10 / pack	1/10/30	720	
441456	oval	brown	106 cm	11 x 5 mm	20 cm	Metal	3 pack	10 / pack	1/10/30	720	



Ref. no.	Description	Colour	Material	MOQ	Pieces / unit		€
441316	Additional Insulator Clip for Round Steel Post	black	Plastic	1 pouch	25 / pouch	1/25/400	
441318	Spare Insulator for Round Steel Post	black	Plastic	1 pouch	25 / pouch	1/25/500	
441315/251	Spare Insulator for Oval Steel Post	black	Plastic	1 pack	25 / pack	1/12	
4413151	Spare Insulator for Oval Steel Post	black	Plastic	1 pouch	25 / pouch	1/25/400	
441317/201	Spare Insulator for oval Steel Post	black	Plastic	1 pack	20 / pack	1/12	
4413171	Spare Insulator for oval Steel Post	black	Plastic	1 pouch	25 / pouch	1/25/500	
441421	Charge Insulator for Oval Steel Post	red	Plastic	1 pouch	50 / pouch	1/50/1800	
44432	Spare Insulator with Metal Eyelet for Oval Steel Post	black	Plastic	1 pouch	25 / pouch	1/25/500	
44433	Spare Ring Insulator for Oval Steel Post	black	Plastic	1 pouch	25 / pouch	1/25/500	



## Eyelet Metal Post

- white post with eye
- HDPE insulation
- Single step with double prong





Ref. no.	Colour	Total Height	Post Ø	Length Ground Nail	Material Ground Nail	MOQ	Pieces / unit			€
44456	white	105 cm	7 mm	15 cm	Metal	1 pack	10 / pack	1/10	1,000	

## Spring Steel Post with Eyelets

- galvanised post with eyelet
- HDPE insulation
- Single step with double prong



Ref. no.	Colour	Total Height	Post Ø	Length Ground Nail	Material Ground Nail	MOQ	Pieces / unit			€
441474	white	109 cm	6.5 mm	17 cm	Metal	1 pack	10 / pack	1/10	1,000	

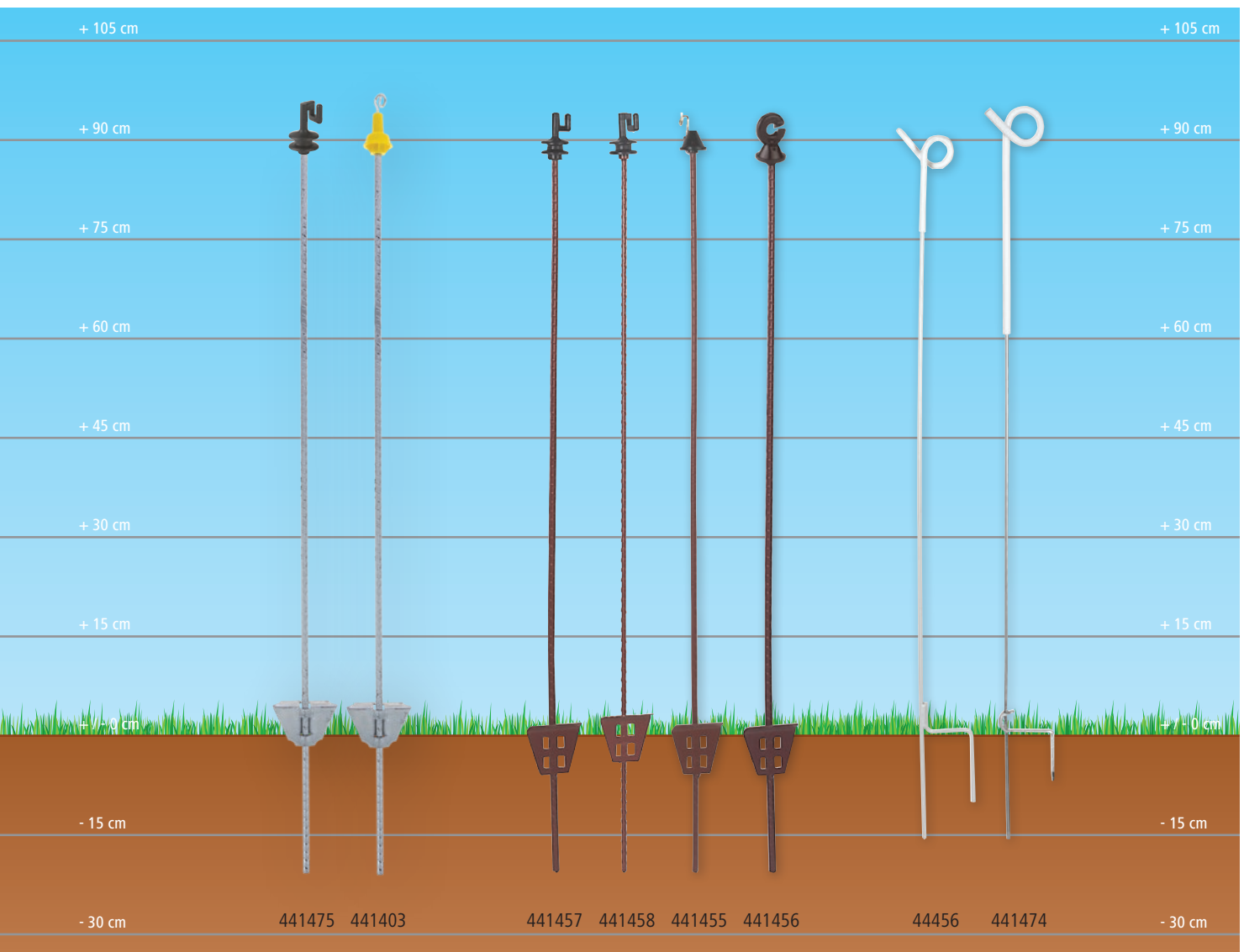

# Metal Posts



## Angular Steel Post

The angled steel posts are suitable for all-year-round use. There is no danger of breaking, even at the lowest temperatures.

- excellent for dry and rocky areas
- powder-coated
- with double step

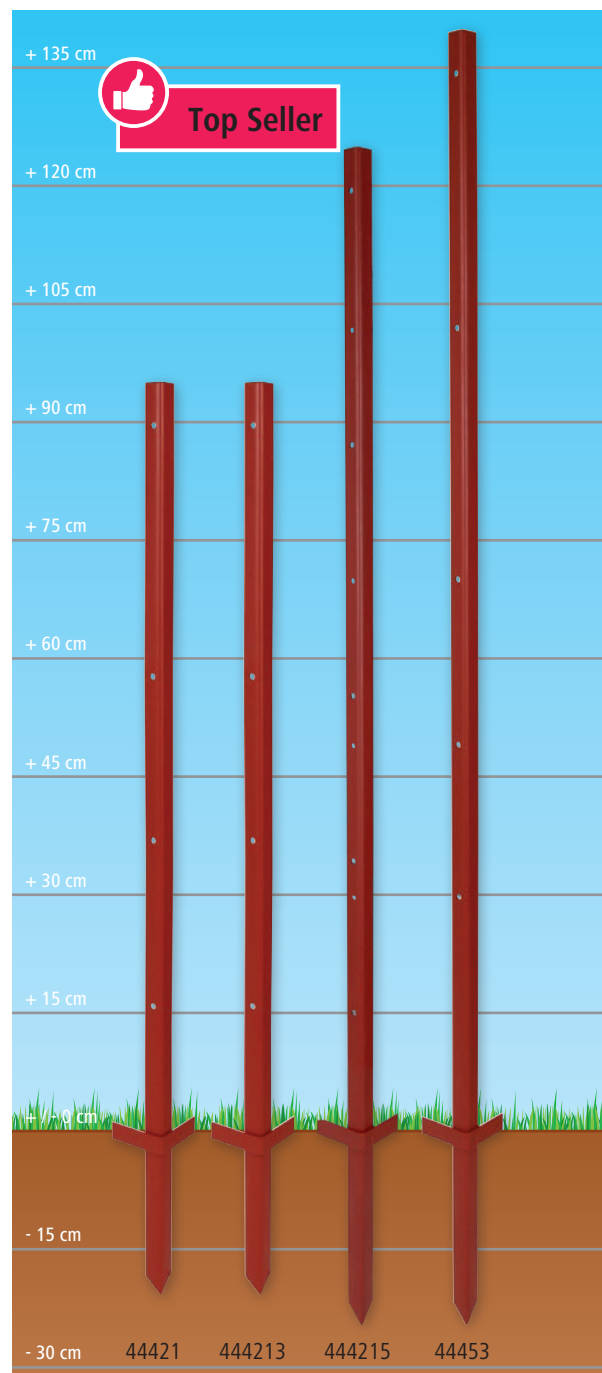
444215: with holes at 20, 40, 60, 90, 120 cm – ideal for 5-row wolf defence fences





Ref. no.	Colour	Total Height	Material Thickness	Length Ground Nail	Holes	MOQ	Pieces / unit			€
44421	red	115 cm	2 mm	18 cm	4	1 pack	10 / pack	1/10	500	
444213	red	115 cm	3 mm	18 cm	4	1 pack	10 / pack	1/10	500	
444215	red	150 cm	3 mm	20 cm	5	1 pack	10 / pack	1/10	500	
44453	red	165 cm	3 mm	20 cm	5	1 pack	10 / pack	1/10	500	

## Splint Insulator for angled Steel Post

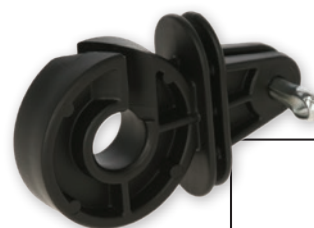
- new improved version – now even more robust
- incl. metal pin
- Material: Polypropylene
- suitable for: Poly Wire, Rope, tape up to 10 mm



Ref. no.	MOQ	Pieces / unit			€
446530	1 pouch	25 / pouch	1/25/500	18,000	
446530/1257	1 bucket	125 / bucket	1	96	

# Fibreglass Posts and Accessories

Special polyester fleece coating gives the pile a visible honeycomb structure on the surface.

### Advantages:

- absolutely smooth surfaces and therefore no unpleasant fibreglass residues on the skin
- significantly increased UV-- resistance compared with standard fibreglass posts

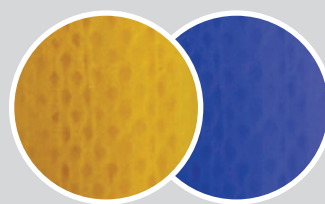

## Oval Fibreglass Post Premium BLUE

- incl. head insulator with plastic eyelet (suitable for wire, stranded wire, rope and tape up to 20 mm)
- very easy to insert and remove the conductor material by turning
- height-adjustable spare insulator available separately (444289)
- with single step





5-year UV stability warranty



with polyester fleece coating

444291, 444292 and 444299: additional reinforcement thanks to sturdy metal sleeve at the transition from the post to the ground nail



Ref. no.	Colour	Total Height	Post Ø	Length Ground Nail	Material Ground Nail	MOQ	Pieces / unit			€
444299	blue	110 cm	10 x 8 mm	18 cm	Metal	1 pack	10 / pack	1/10	800	

## Spare Insulator/additional Insulator

for Oval Fibreglass Post Premium BLUE

- variable height of pole insulator
- absolutely secure attachment
- ideal for retrofitting oval fibreglass post 444299

Ref. no.	MOQ	Pieces / unit		€
444289	1 pack	25 / pack	1/25/1000	



# Fibreglass Posts and Accessories

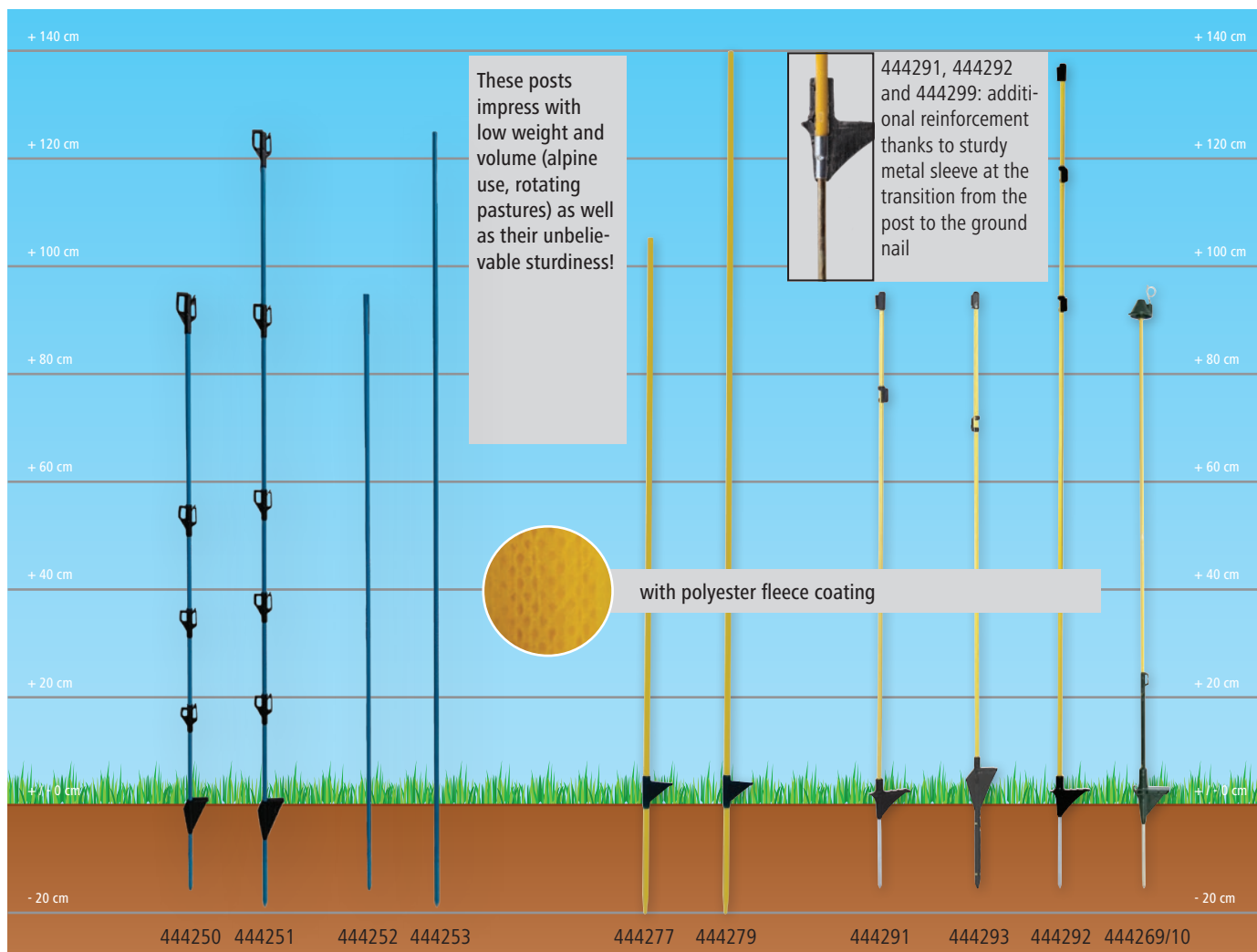

## Round Fibreglass Post

- low weight
- extra robust design
- ideal for cattle, horse and sheep pens
- Insulators not included!
- with polyester fleece coating

5-year UV stability warranty



Ref. no.	Description	Colour	Total Height	Post Ø	Length Ground Nail	Material Ground Nail	MOQ	Pieces / unit			€
444277	with single step	yellow	125 cm	12 mm	20 cm	Fibreglass	1 pack	10 / pack	1/10		1,400
444279	with single step	yellow	160 cm	12 mm	20 cm	Fibreglass	1 pack	10 / pack	1/10		1,400

## Oval Fibreglass Post

- ideal for cattle, horse and sheep pens
- ideal for poly wires, wires and tapes up to 20 mm
- with single step

444269/10: incl. head insulator with metal ring, without polyester fleece coating

444291: incl. head insulator and height-adjustable additional insulator

- with polyester fleece coating

444293: incl. head insulator and height-adjustable additional insulator

- with polyester fleece coating

444292: incl. head insulator and 2 x height-adjustable additional insulators

- with polyester fleece coating

5-year UV stability warranty



Ref. no.	Colour	Total Height	Post Ø	Length Ground Nail	Material Ground Nail	MOQ	Pieces / unit			€
444269/10	yellow / black	106 cm	10 x 6 mm	18 cm	Metal	1 pack	10 / pack	1/10		1,000
444291	yellow / black	110 cm	10 x 8 mm	18 cm	Metal	1 pack	10 / pack	1/10		1,000
444293	yellow / black	110 cm	10 x 8 mm	22 cm	Fibreglass	1 pack	10 / pack	1/10		1,400
444292	yellow / black	152 cm	10 x 8 mm	18 cm	Metal	1 pack	10 / pack	1/10		1,000

## Round Fibreglass Post compact+

- ideal for mobile fencing systems - single footstep enables quick and effortless erection
- high flexibility and break resistance thanks to robust fibreglass - reliable in all weather conditions
- Spacers between the permanently installed insulators comply with official herd protection requirements
- Insulators are suitable for all common stranded wires, ropes and wide strips up to 20 mm
- signal blue colour ensures good visibility for people and animals

New product

NEW



Ref. no.	Colour	Total Height	Post Ø	MOQ	Pieces /			€
444250	blue	117 cm	9.5 mm	1 pack	10 / pack	1/10/50	800	
444251	blue	147 cm	9.5 mm	1 pack	10 / pack	1/10/50	800	

available from: April 2026



## Round Fibreglass Post compact

- ideal for mobile fencing systems - also suitable for keeping wild animals at bay and herd protection (with longer versions)
- high flexibility and break resistance thanks to robust fibreglass - reliable in all weather conditions
- signal blue colour ensures good visibility for people and animals
- ideal for cattle, horse and sheep pens
- Supplied without insulators and foot step

New product

NEW



Ref. no.	Colour	Total Height	Post Ø	MOQ	Pieces / unit			€
444252	blue	117 cm	9.5 mm	1 pack	10 / pack	1/10/80	4,480	
444253	blue	147 cm	9.5 mm	1 pack	10 / pack	1/10	4,480	

available from: April 2026

## Spare Spring

for round fibreglass post

- variable adjustment of pole eyelet • clip-on • Material: Stainless Steel • suitable for: Wire, Poly Wire, Rope

Ref. no.	Description	MOQ	Pieces / unit		€
444265/30	for fibreglass rods of diameter 10 mm	1 pouch	30 / pouch	1/30/1500	

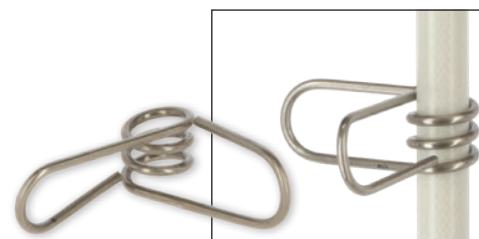

## Plastic Eyelets

for round fibreglass post

- variable adjustment of pole eyelet • clip-on • suitable for: Wire, Poly Wire, Rope, tape up to 10 mm

Ref. no.	Description	Colour	MOQ	Pieces / unit			€
444011	for fibreglass rods of diameter 10 mm	white	1 pouch	50 / pouch	1/50/1000	18,000	
444012	for fibreglass rods of diameter 12 mm	white	1 pouch	50 / pouch	1/50/1000	25,000	

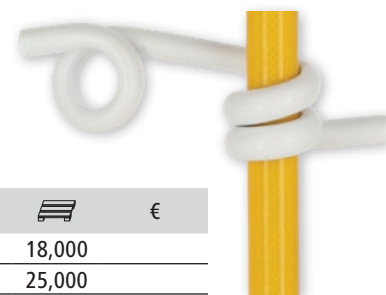

## Additional Insulator for Oval Fibreglass Post

- variable height of pole insulator • absolutely secure attachment • clip-on • Material: Plastic
- suitable for: Poly Wire, Rope, tape up to 10 mm
- suitable for oval fibreglass post 444291, 444292, 444293

Ref. no.	Colour	MOQ	Pieces / unit		€
444263	black	1 pack	25 / pack	1/25/1000	





## Plastic Post with Stirrup Step

- stable stand thanks to fibreglass-reinforced plastic - no bending or breaking
- durable and weatherproof, even after years of outdoor use
- very robust stirrup tread for optimum treading - unbreakable even on hard floors
- can be used for all common tapes, ropes, strands or wires
- corrosion-protected nail for permanent rust protection and secure hold

44417: incl. head insulator for stranded wire, wire and 10 mm tape - also for twisting the stranded wire

444170: incl. head insulator for stranded wire, wire and 10 mm tape - also for twisting the stranded wire



Ref. no.	Colour	Total Height	Length Ground Nail	Material Ground Nail	Eyelets	MOQ	Pieces / unit			€
44417	green	114.5 cm	19 cm	galvanised metal	1 x Poly Wire, 2 x Rope, 4 x tape (20 mm), 2 x tape (40 mm)	1 pack	5 / pack	1/5		390
44418	green	158 cm	19 cm	galvanised metal	4 x Rope, 4 x tape (20 mm), 4 x tape (40 mm)	4 pack	5 / pack	1/5/20		360
444170	white	114.5 cm	19 cm	galvanised metal	1 x Poly Wire, 2 x Rope, 4 x tape (20 mm), 2 x tape (40 mm)	1 pack	5 / pack	1/5		390
444180	white	158 cm	19 cm	galvanised metal	4 x Rope, 4 x tape (20 mm), 4 x tape (40 mm)	4 pack	5 / pack	1/5/20		360

## Plastic Post Premium

- made from sturdy, impact resistant plastic
- nearly indestructible single tread bar
- with an especially long and reinforced 9 mm thick ground nail
- for all conventional tapes, poly wires, ropes and wires
- vertically reinforced for increased stability

441813: incl. head insulator for poly wire, wire and 10 mm tape - also for twisting the poly wire



Ref. no.	Colour	Total Height	Length Ground Nail	Material Ground Nail	Eyelets	MOQ	Pieces / unit			€
441813	white	107 cm	20 cm	galvanised metal	1 x Poly Wire, 2 x Rope, 5 x tape (20 mm), 2 x tape (40 mm)	1 pack	5 / pack	1/5		675
441814	white	147 cm	20 cm	galvanised metal	4 x rope (6 mm), 5 x tape (20 mm), 4 x tape (40 mm)	4 pack	5 / pack	1/5/20		660

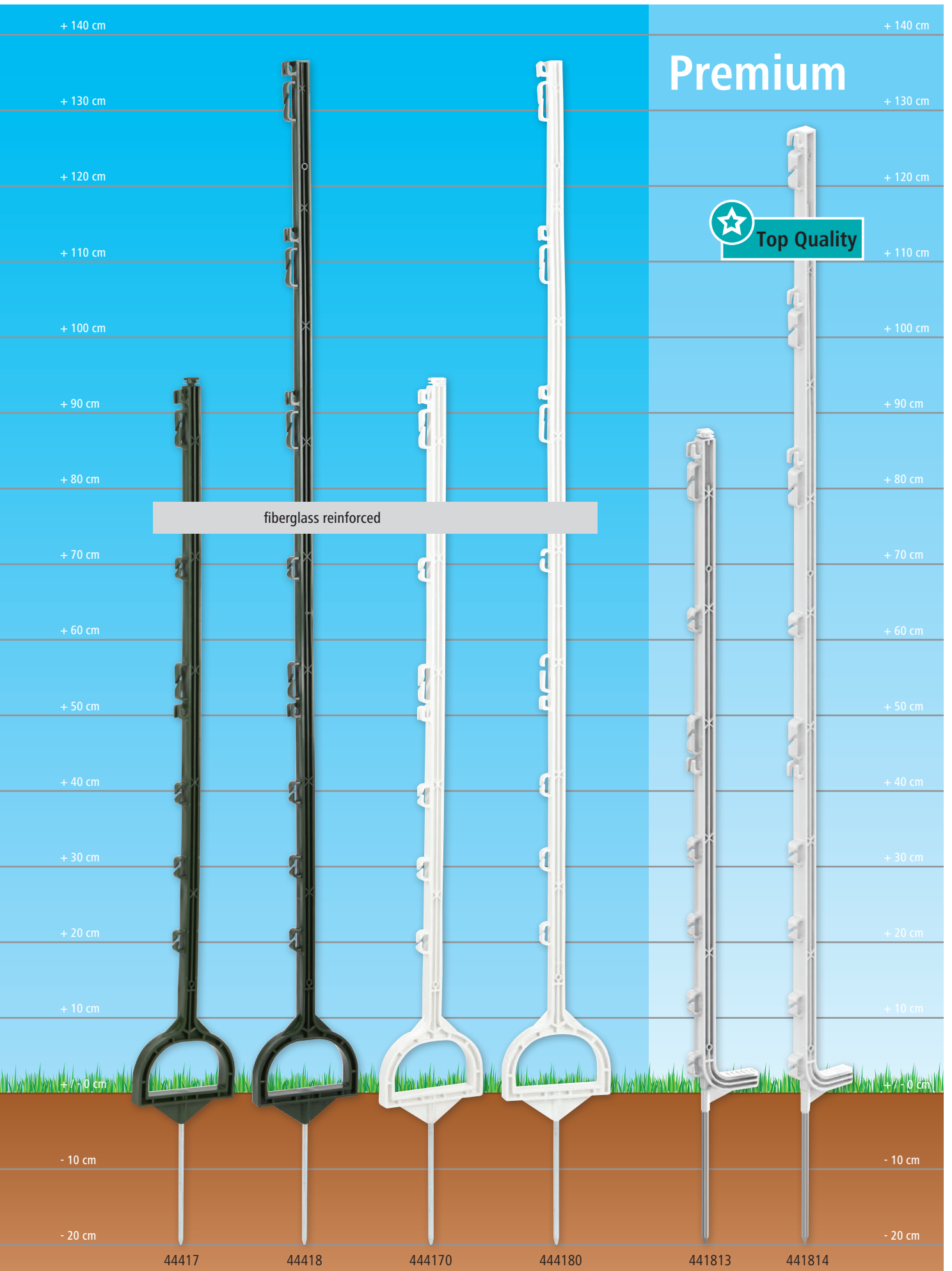

with special honey-comb structure



## Plastic Post Titan Plus

- highly impact-resistant, high-grade plastic, virtually unbreakable
- also suited for sub-zero temperatures
- for all conventional tapes, poly wires, ropes and wires
- vertically reinforced for increased stability
- with galvanised ground nail
- with single step



3-year UV stability warranty



metal step-in reinforcement provides extremely high stability

Ref. no.	Colour	Total Height	Length Ground Nail	Material Ground Nail	Eyelets	MOQ	Pieces / unit			€
4418083	blue	110 cm	16 cm	galvanised metal	5 x Rope, 1 x tape (20 mm), 2 x tape (40 mm)	1 pack	5 / pack	1/5	490	
441808	white	110 cm	16 cm	galvanised metal	5 x Rope, 1 x tape (20 mm), 2 x tape (40 mm)	1 pack	5 / pack	1/5	490	
441809	white	157 cm	19 cm	galvanised metal	7 x Rope, 1 x tape (20 mm), 4 x tape (40 mm)	4 pack	5 / pack	1/5/20	500	
441807	white	157 cm	20 cm	galvanised metal	7 x Rope, 1 x tape (20 mm), 4 x tape (40 mm)	4 pack	5 / pack	1/5/20	500	NEW

## Plastic Post Titan

- highly impact-resistant, high-grade plastic, virtually unbreakable
- also suited for sub-zero temperatures
- for all conventional tapes, poly wires, ropes and wires
- vertically reinforced for increased stability
- with galvanised ground nail
- with single step



3-year UV stability warranty



Ref. no.	Colour	Total Height	Length Ground Nail	Material Ground Nail	Eyelets	MOQ	Pieces / unit			€
441802	white	110 cm	18 cm	galvanised metal	5 x Rope, 1 x tape (20 mm), 2 x tape (40 mm)	1 pack	5 / pack	1/5	490	

## Plastic Post Titan

- highly impact-resistant, high-grade plastic, virtually unbreakable
- also suited for sub-zero temperatures
- for all conventional tapes, poly wires, ropes and wires
- vertically reinforced for increased stability
- with galvanised ground nail
- with double step



3-year UV stability warranty



Ref. no.	Colour	Total Height	Length Ground Nail	Material Ground Nail	Eyelets	MOQ	Pieces / unit			€
441800	white	110 cm	18 cm	galvanised metal	5 x Rope, 1 x tape (20 mm), 2 x tape (40 mm)	1 pack	5 / pack	1/5	350	
441801	white	157 cm	21 cm	galvanised metal	7 x Rope, 1 x tape (20 mm), 4 x tape (40 mm)	4 pack	5 / pack	1/5/20	500	

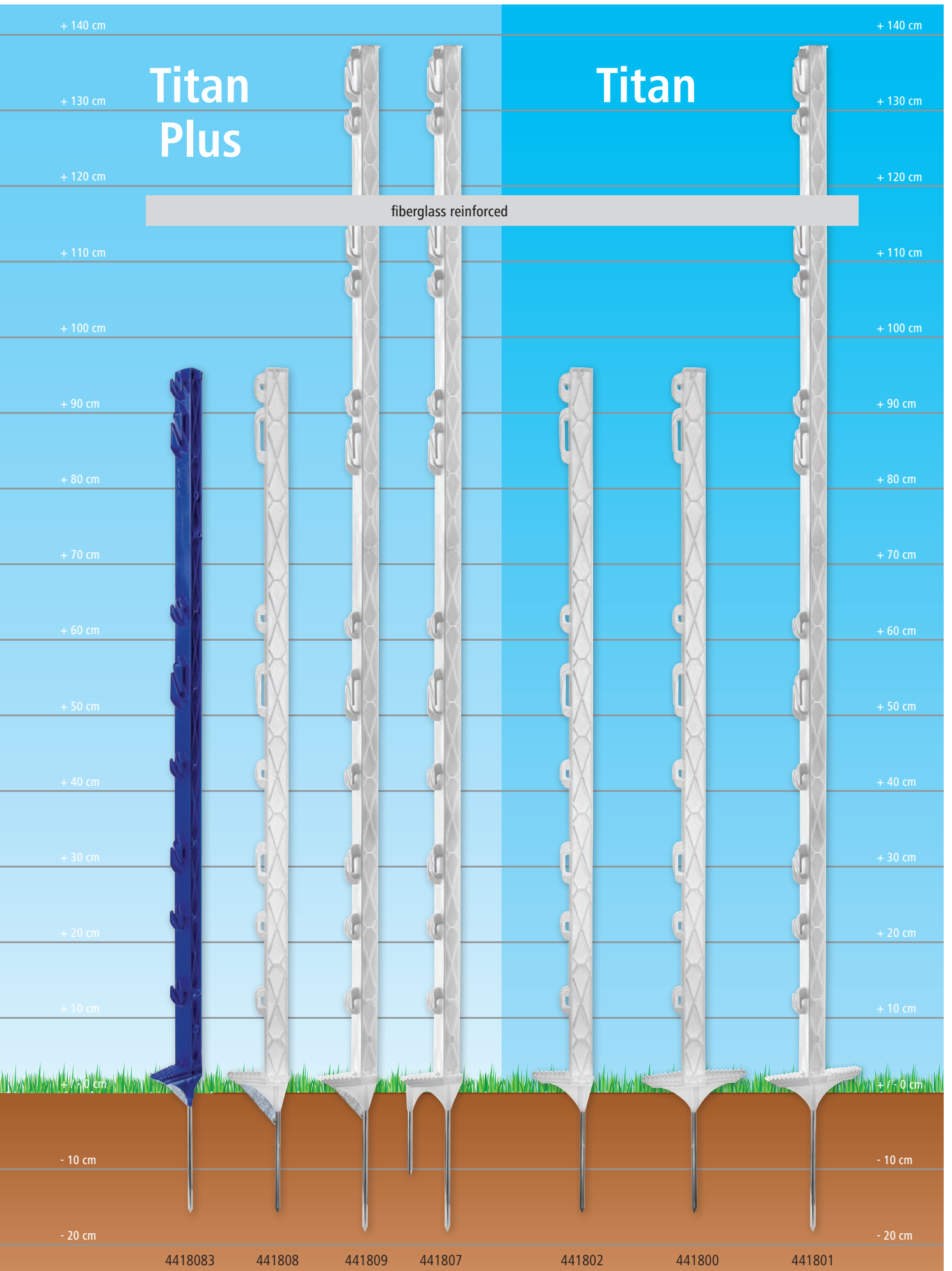





## Plastic Post Expert

- for all conventional tapes, poly wires, ropes and wires
- vertically reinforced for increased stability
- with galvanised ground nail
- with single step



3-year UV stability warranty



Ref. no.	Colour	Total Height	Length Ground Nail	Material Ground Nail	Eyelets	MOQ	Pieces / unit			€
443421	white	105 cm	18 cm	galvanised metal	2 x Rope, 3 x tape (20 mm), 2 x tape (40 mm)	1 pack	5 / pack	1/5		630
443412	white	156 cm	21 cm	galvanised metal	4 x Rope, 3 x tape (20 mm), 4 x tape (40 mm)	6 pack	5 / pack	1/5/30		750

## Plastic Post Expert

- for all conventional tapes, poly wires, ropes and wires
- vertically reinforced for increased stability
- with galvanised ground nail
- with double step













443422-RE:

- Our top seller made from sustainable material at a promotional price!



3-year UV stability warranty



Ref. no.	Colour	Total Height	Length Ground Nail	Material Ground Nail	Eyelets	MOQ	Pieces / unit			€
443422	white	105 cm	18 cm	galvanised metal	2 x Rope, 3 x tape (20 mm), 2 x tape (40 mm)	1 pack	5 / pack	1/5		485
443422/1120	white	105 cm	18 cm	galvanised metal	2 x Rope, 3 x tape (20 mm), 2 x tape (40 mm)	112 pack	10 / pack	1/10		1,120
443422-RE	anthracite	105 cm	18 cm	galvanised metal	2 x Rope, 3 x tape (20 mm), 2 x tape (40 mm)	1 pack	5 / pack	1/5		485
443423	blue	105 cm	18 cm	galvanised metal	2 x Rope, 3 x tape (20 mm), 2 x tape (40 mm)	1 pack	5 / pack	1/5		485
443492	white	125 cm	21 cm	galvanised metal	3 x Rope, 3 x tape (20 mm), 3 x tape (40 mm)	4 pack	5 / pack	1/5/20		500
443493	white	156 cm	21 cm	galvanised metal	4 x Rope, 3 x tape (20 mm), 4 x tape (40 mm)	4 pack	5 / pack	1/5/20		500
443493/40	white	156 cm	21 cm	galvanised metal	4 x Rope, 3 x tape (20 mm), 4 x tape (40 mm)	1 box	40 / box	1		9
443493/1050	white	156 cm	21 cm	galvanised metal	4 x Rope, 3 x tape (20 mm), 4 x tape (40 mm)	105 pack	10 / pack	1/10		1,050
4434932	green	156 cm	21 cm	galvanised metal	4 x Rope, 3 x tape (20 mm), 4 x tape (40 mm)	4 pack	5 / pack	1/5/20		500
4434937	petrol	156 cm	21 cm	galvanised metal	4 x Rope, 3 x tape (20 mm), 4 x tape (40 mm)	4 pack	5 / pack	1/5/20		500
4434938	pink	156 cm	21 cm	galvanised metal	4 x Rope, 3 x tape (20 mm), 4 x tape (40 mm)	4 pack	5 / pack	1/5/20		500

## Expert

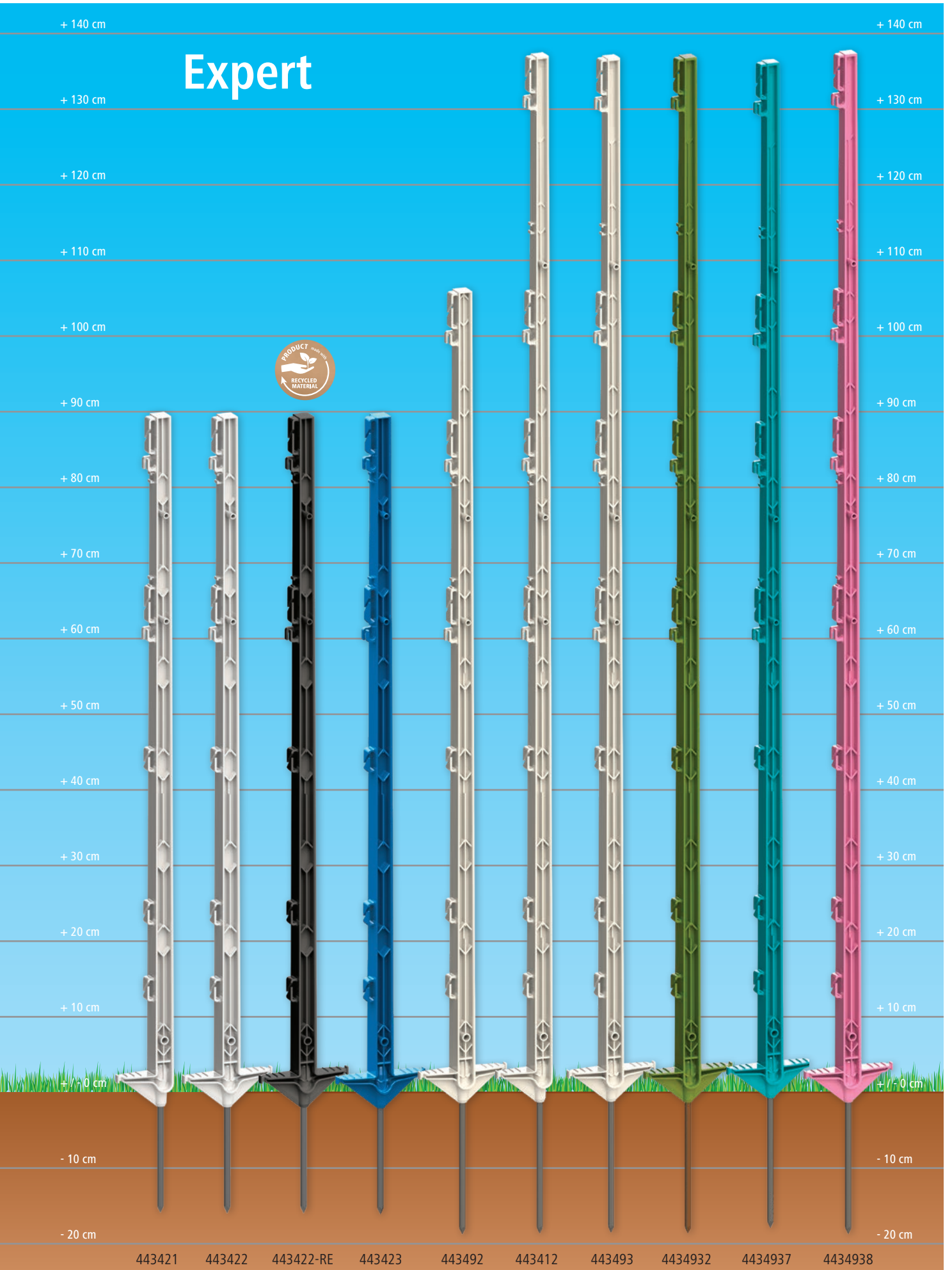

## Plastic Post Basic

- for all conventional tapes, poly wires, ropes and wires
- vertically reinforced for increased stability
- with galvanised ground nail



3-year UV stability warranty



Ref. no.	Description	Colour	Total Height	Length Ground Nail	Material Ground Nail	Eyelets	MOQ	Pieces / unit			€
44491	with double step	white	105 cm	17 cm	galvanised metal	5 x Rope, 2 x tape (20 mm), 1 x tape (40 mm)	1 pack	5 / pack	1/5		560
444912	with double step	green	105 cm	17 cm	galvanised metal	5 x Rope, 2 x tape (20 mm), 1 x tape (40 mm)	1 pack	5 / pack	1/5		560 <span style="color: blue;">NEW</span>

## Plastic Post Eco

- for all conventional tapes, poly wires, ropes and wires
- vertically reinforced for increased stability
- with galvanised ground nail
- with single step



Ref. no.	Colour	Total Height	Length Ground Nail	Material Ground Nail	Eyelets	MOQ	Pieces / unit			€
441810	white	70 cm	18 cm	galvanised metal	5 x tape (20 mm)	1 pack	5 / pack	1/5		1,200
4418102	green	70 cm	18 cm	galvanised metal	5 x tape (20 mm)	1 pack	5 / pack	1/5		1,200
441812	white	105 cm	18 cm	galvanised metal	7 x tape (20 mm), 1 x tape (40 mm)	1 pack	5 / pack	1/5		1,000

## Plastic Post

- with galvanised ground nail



5-year UV stability warranty



Ref. no.	Description	Colour	Total Height	Post Ø	Length Ground Nail	Material Ground Nail	MOQ	Pieces / unit			€
44400	no tread	white	108 cm	19 mm	23 cm	galvanised metal	1 pack	10 / pack	1/10		1,000
44405	with single step	white	108 cm	19 mm	26 cm	galvanised metal	1 pack	10 / pack	1/10		1,000
44499	with single step	white	158 cm	19 mm	26 cm	galvanised metal	1 pack	10 / pack	1/10		

Ref. no.	Description	Colour	Material	Ø	MOQ	Pieces / unit		€
44403	Additional Eyelet for Plastic Post for wire, poly wire, rope and 10 mm tape	white	PVC	19 mm	1 pouch	25 / pouch	1/25/1000	
44404	Additional Eyelet for Plastic Post tape up to 40 mm	white	PVC	19 mm	1 pouch	25 / pouch	1/25/750	

# Plastic Posts and Accessories

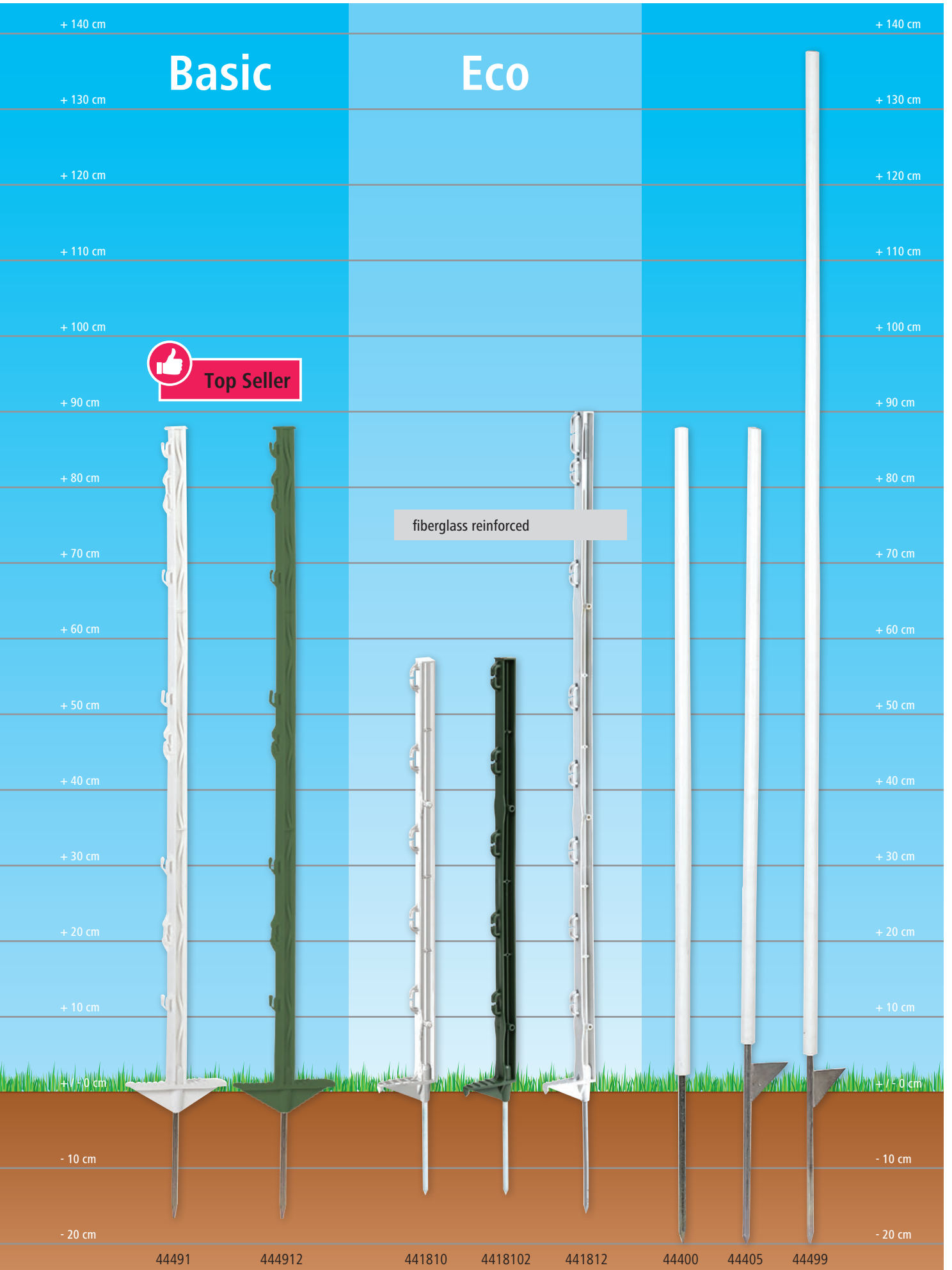

# Insulators



Insulators separate the conductor material from the post and prevent unwanted discharge into the ground. There are insulators for each area of application, specially developed for each conductor material or the various types of post. For most insulators, the following applies: the larger the insulator, the better its insulating properties. For corners and junctions, extra robust insulators should be used because there are high tensile forces here that put high stress on the material. Along with their insulating properties, our insulators also make it easier to work with the various conductor materials. For example, with the right insulator, you can re-tension sagging conductor material with just a few actions or take care of partially torn tapes for re-electrification.

We divide our insulators into the following types of applications:

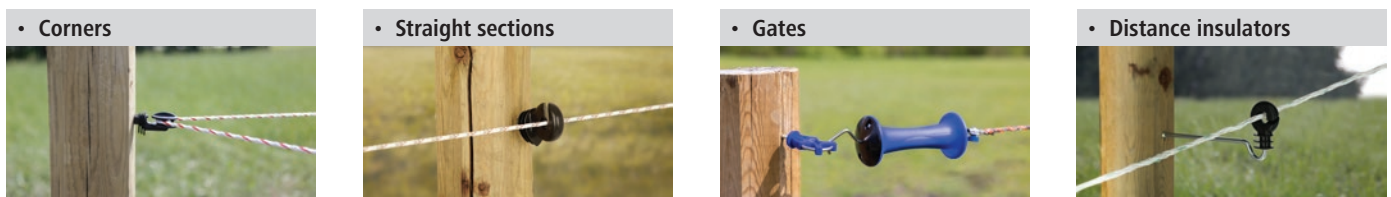

## Wood Screw

- hexagon round head
- for securing insulators
- including bit insert TX20
- 4.5 x 35 mm galvanised
- with wood thread

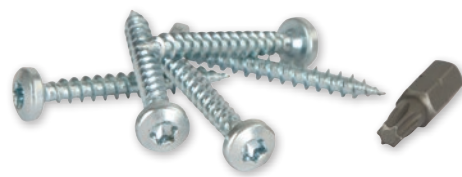

Ref. no.	Length	MOQ	Pieces / unit		€
442610/1001	35 mm	1 pack	100 / pack	1	

## Screwdriver for Ring and Clip Insulator

- for drills and battery screwdrivers
- easily screwed in due to its round shape
- Material: Plastic

also suitable for Maxi Tape insulator 441390 and Allgäu 441381 as well as ring insulators

Ref. no.	Pieces / unit		€
441363/011	1 / pack	1	

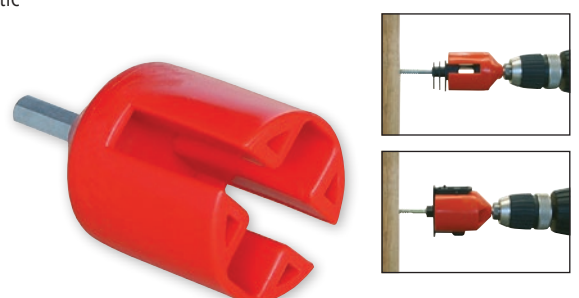

# Ring Insulators with continuous Support

## Ring Insulator 2K EDX

- ideal insulator for increased fence safety: the contrasting coloured ring shows at a glance whether the insulator is still sufficiently thick to fulfil its function or whether it must be replaced
- loss of the required fence voltage due to dissipation by the conductor material on the robust metal core in the insulator is prevented, because the insulator can be replaced in good time
- pronounced drip noses reliably prevent loss of voltage on the conductor material caused by flashover to paddock post, even during rain and high moisture levels
- impact-resistant, robust plastic body with fibreglass reinforcement; provides excellent insulation properties thanks to its large volume
- self-cutting EDX thread for wood can be screwed in twice as easily as standard posts – the wood is ‘cut’ not ‘displaced’
- no need for pre-drilling, even for hard wood
- far less fracturing in wood when screwed in
- ideal for use with screwdriver 441363/011
- Material: glass-fibre reinforced, UV-stabilised plastic
- with continuous galvanised support
- suitable for: Wire, Poly Wire, Rope, tape up to 10 mm



New product

NEW

Made in the EU



10-year UV stability warranty

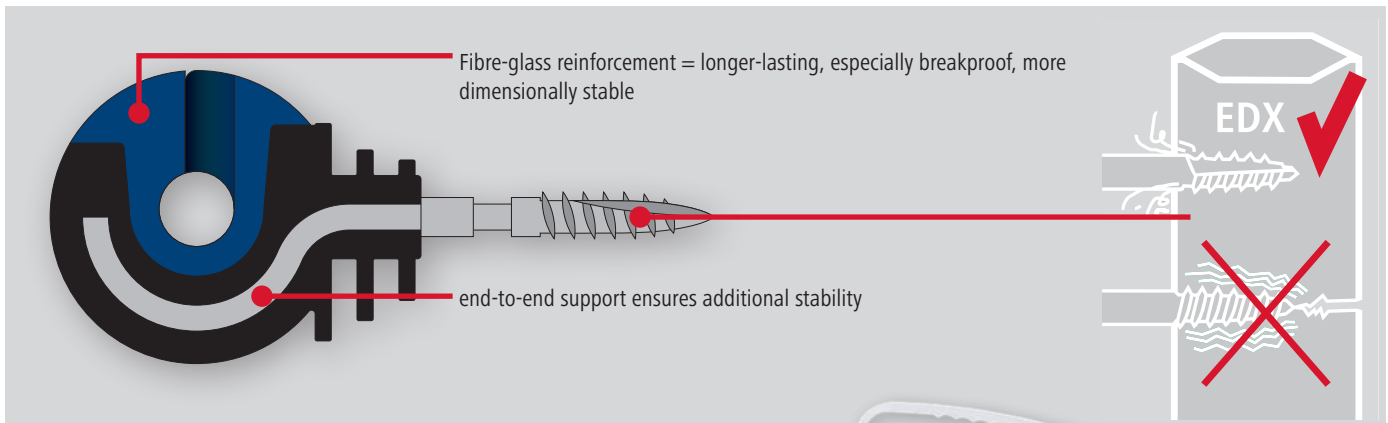

Ref. no.	MOQ	Pieces / unit		€
446599	1 pouch	25 / pouch	1/25/500	
446599/251	1 pack	25 / pack	1/14	
446599/1253	1 bucket	125 / bucket	1	



available from: March 2026

# Ring Insulators with continuous Support

The long support runs through the insulating plastic body, which makes these insulators particularly robust.

## EDX - the self-cutting thread

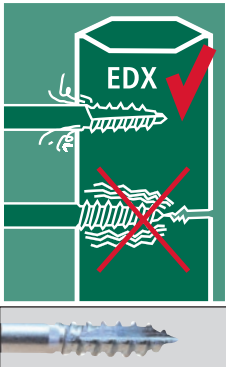

## Ring Insulator Easy Drill EDX with continuous support

- 2 x as easy to screw in as standard supports – the wood is 'cut' not 'displaced'
- no need for pre-drilling for hard wood
- far less fracturing in wood when screwed in
- best possible insulation properties
- ideal for use with screwdriver 441363/011
- with self-cutting wooden thread EDX
- Material: impact-resistant plastic
- with continuous galvanised support  $\varnothing$  6 mm
- suitable for: Wire, Poly Wire, Rope, tape up to 10 mm

443269/753E: with free screwdriver

Ref. no.	Colour	MOQ	Pieces / unit		€
443269	black	1 pouch	25 / pouch	1/25/500	
443269/201	black	1 pack	20 / pack	1/14	
443269/753E	black	1 bucket	75 / bucket	1	



## Ring Insulator

- with wide wire support
- ideal for use with screwdriver 441363/011
- with wood thread
- Material: Plastic
- with continuous galvanised support  $\varnothing$  5,3 mm
- suitable for: Poly Wire, Rope, tape up to 10 mm

44314/1003E: with free screwdriver

44314/2503E: with free screwdriver

44314/3003E: with free screwdriver



44314/2503E

incl. long-lasting and robust 12-litre stable/construction bucket with transparent lid



44314/100-RE  
made from recycled material  
with same quality standard



Ref. no.	Colour	MOQ	Pieces / unit		€
44314	black	1 pouch	25 / pouch	1/25/500	
44314/251	black	1 pack	25 / pack	1/14	
449314	black	1 pouch	50 / pouch	1/50/500	
44314/100-RE	anthracite	1 pack	100 / pack	1	
44314/1003E	black	1 bucket	100 / bucket	1	
44314/2503E	black	1 bucket	250 / bucket	1	
44314/3003E	black	1 bucket	300 / bucket	1	



# Ring Insulators with short Support

The short support allows generous use of plastic material and therefore offers very good insulating properties.

## EDX - the self-cutting thread

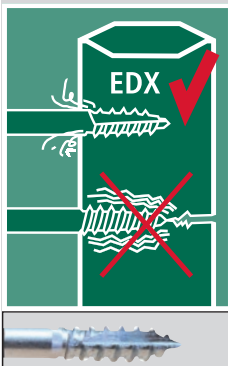

## Ring Insulator Easy Drill EDX

- 2 x as easy to screw in as standard supports – the wood is 'cut' not 'displaced'
- no need for pre-drilling for hard wood
- far less fracturing in wood when screwed in
- best possible insulation properties
- ideal for use with screwdriver 441363/011
- with wood thread
- Material: impact-resistant plastic
- with short galvanised support Ø 6 mm
- suitable for: Wire, Poly Wire, Rope, tape up to 10 mm

443279/903E: with free screwdriver



Ref. no.	Colour	MOQ	Pieces / unit		€
443279	black	1 pouch	25 / pouch	1/25/500	
443279/201	black	1 pack	20 / pack	1/14	
443279/903E	black	1 bucket	90 / bucket	1	

## Ring Insulator Premium BIG

- with wide slit for rope
- with wood thread
- Material: Plastic
- with short galvanised support Ø 6 mm
- suitable for: Wire, Poly Wire, Rope, tape up to 10 mm

Ref. no.	Colour	MOQ	Pieces / unit		€
441385	black	1 pack	25 / pack	1/25/500	

## Ring Insulator

- with wide wire support • ideal for use with screwdriver 441363/011 • with wood thread • Material: Plastic • with short galvanised support Ø 6 mm • suitable for: Rope, Poly Wire, tape up to 10 mm

Ref. no.	Colour	MOQ	Pieces / unit		€
44316	black	1 pouch	25 / pouch	1/25/500	
44316/251	black	1 pack	25 / pack	1/14	
44316/903	black	1 bucket	90 / bucket	1	

## Ring Insulator Compact

- with wide wire support
- ideal for use with screwdriver 441363/011
- with wood thread
- Material: Plastic
- with short galvanised support Ø 5 mm
- suitable for: Rope, Poly Wire, tape up to 10 mm

Ref. no.	Colour	MOQ	Pieces / unit		€
44306	black	1 pouch	25 / pouch	1/25/500	
44306/251	black	1 pack	25 / pack	1/14	
44306/903	black	1 bucket	90 / bucket	1	
44318	red	1 pouch	50 / pouch	1/50/500	
441342	yellow	1 pouch	25 / pouch	1/25/500	

EDX - the self-cutting thread



## Slit Insulators Easy Drill EDX

- extra-stable slit insulator made from breakproof polycarbonate
- suitable for extreme temperature and weather conditions
- best insulating properties thanks to large plastic body
- includes matching screw-in tool (441379)
- with self-cutting wooden thread EDX
- with galvanised support  $\varnothing$  7 mm
- suitable for: Poly Wire, Wire

polycarbonate = highly break-proof and durable!



Free screwdriver!

Ref. no.	Colour	MOQ	Pieces / unit		€
441373/503E	red	1 bucket	50 / bucket	1	



## Slit Insulators Premium

- excellent insulation qualities
- with wood thread
- with continuous galvanised support  $\varnothing$  6 mm
- suitable for: Poly Wire, Wire

polycarbonate = highly break-proof and durable!

Ref. no.	Colour	MOQ	Pieces / unit		€
44302	red	1 pouch	25 / pouch	1/25/500	
44302/251	red	1 pack	25 / pack	1/14	



## Slit Insulators

- excellent insulation qualities
- with wood thread
- Material: Plastic
- with continuous galvanised support  $\varnothing$  5,3 mm
- suitable for: Poly Wire, Wire



Ref. no.	Colour	MOQ	Pieces / unit		€
44300	black	1 pouch	25 / pouch	1/25/500	
44300/301	black	1 pack	30 / pack	1/14	
44305	red	1 pouch	100 / pouch	1/100/1000	22,99



## Combi Insulator Premium

- combines various uses of conductor materials in ONE insulator
- excellent insulation characteristics due to large, wide drip-zones emphasise the high quality of this insulator
- ideal for use with screwdriver 441363/011
- with wood thread
- Material: Plastic
- with short galvanised support  $\varnothing$  6 mm
- suitable for: Poly Wire, Rope, tape up to 20 mm

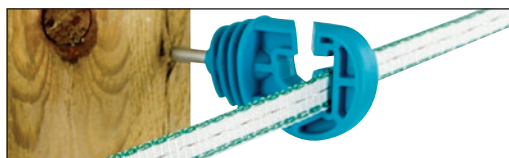

proven a hundred thousand times over!

Ref. no.	Colour	Support Length	MOQ	Pieces / unit		€
441370	red	37 mm	1 pouch	25 / pouch	1/25/500	
441380	black	37 mm	1 pouch	25 / pouch	1/25/500	
441380/351	black	37 mm	1 pack	35 / pack	1/12	
441371	pink	37 mm	1 pouch	25 / pouch	1/25/500	
441372	petrol	37 mm	1 pouch	25 / pouch	1/25/500	

## Ring Insulator Easy Drill SX green

- insulator made of sustainable bio-based plastic - from 100 % renewable raw materials
- wood look thanks to small natural wood chips in the bio-plastic
- extremely robust and impact-resistant
- best possible insulation properties
- high-quality wood screw (5 x 80 mm) is enclosed separately and enables quick and easy mounting of the insulator using a cordless screwdriver (no separate screwdriver required)
- 100 % recyclable - at the end of the product's life, the bio-plastic insulator and screw can be separated and recycled separately
- packaging made from 100 % recycled cardboard
- suitable for: Poly Wire, Rope, tape up to 10 mm

Made in Germany

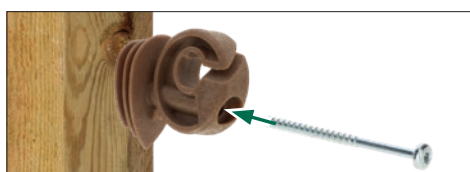

Ref. no.	Colour	MOQ	Pieces / unit		€
44377/502	brown	1 pack	50 / pack	1/10	

## Winder Insulator Allgäu

- easy to tighten / fix in place by winding the conductor material around the insulator
- with wood thread
- Material: impact-resistant plastic, UV-stabilised
- with short galvanised support
- suitable for: Poly Wire, Wire



Ref. no.	Colour	Support Length	MOQ	Pieces / unit		€
441381	black	37 mm	1 pouch	25 / pouch	1/25/500	

## Corner/Stretch Insulator Premium

- electrically conductive rubber inlays through carbon fibres (patented) secure the tape very gently but reliably
- anti-slip by alternating rubber pad structure
- end or strain insulator, also excellent for corners
- mounts easily and strains tapes without fatigue
- screw-on fastening
- Material: Plastic
- suitable for: Poly Wire, Rope, tape up to 40 mm

Made in Germany



Individual interrupted / broken conductor wires are re-electrified by the electricity-conducting rubber.

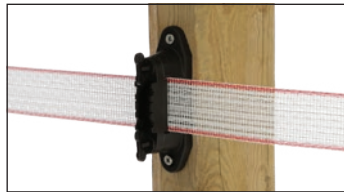
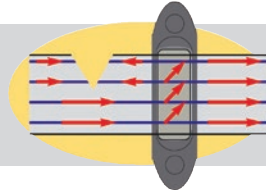

patented

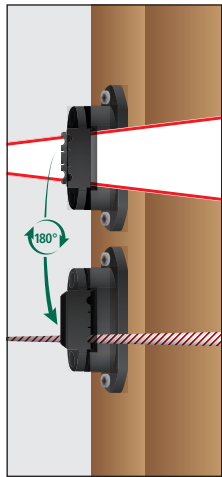

suitable wood screws  
442610/1001



Professional tip:  
very popular for  
horse fences!

• Because of the logical further development of our proven Profi corner/stretch insulator, by turning the upper clamping element through 180 degrees it is now also possible to ensure even more secure fastening, especially for fence ropes and wires. • Our Profi is therefore insulator the universal start/corner/stretch insulator, which makes it simple to tighten all conductor materials.

Ref. no.	Colour	MOQ	Pieces / unit		€
443501	black	1 pouch	10 / pouch	1/10/200	
44350/061	black	1 pack	6 / pack	1/20	

## Tape Corner Insulator Cavallo

- extra strong finish, made from very durable polyamide plastic
- free-running tape is fed through safely thanks to smooth, rounded surface
- with wood thread
- with continuous galvanised support Ø 8 mm
- suitable for: tape up to 40 mm

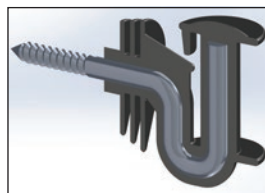

Ref. no.	Colour	MOQ	Pieces / unit		€
441376	black	1 pouch	10 / pouch	1/10/250	
441376/081	black	1 pack	8 / pack	1/50	

## Tape/Rope Tensioner Premium

- easy tape/cable loosening
- simple to add on to existing fence systems
- simple, secure tensioning by hand without tools - thanks to ratchet function
- screw-on fastening
- Material: polyamide glass-fibre reinforced
- suitable for: rope up to Ø 8 mm, tape up to 40 mm



suitable  
wood screws  
442610/1001



Ref. no.	Colour	MOQ	Pieces / unit		€
44578	black	1 pouch	10 / pouch	1/10/100	
44578/041	black	1 pack	4 / pack	1/14	

## Clip Insulator Premium

- ideal as a stretch insulator and tape tensioner
- screw-on fastening
- Material: plastic, UV-stabilised
- suitable for: tape up to 40 mm

Made in Germany



Top Seller

- The double-sided, ribbed rubber inlay provides a reliable and protective hold for the tape along with the patented „clip“ functional principle.
- The inlay prevents the tape from slipping and protects against damage. The tothing above the rubber inlay prevents the tape from slipping out.



patented

suitable  
wood screws  
442610/1001



Ref. no.	Colour	MOQ	Pieces / unit		€
441290	black	1 pouch	10 / pouch	1/10/200	
441290/141	black	1 pack	14 / pack	1/14	
441290/603	black	1 bucket	60 / bucket	1	



## Clip Insulator Maxi Tape

- improved clip mechanism thanks to 2 locking points
- with wood thread
- with galvanised support Ø 6 mm
- suitable for: rope up to Ø 6 mm, tape up to 40 mm



Top Seller

441390/50-RE: plastic made from recycled material with same quality standard

patented

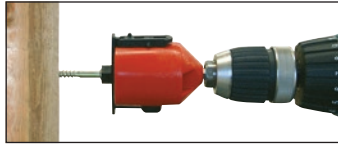

suitable screwdriver  
441363/011



Ref. no.	Colour	Support Length	MOQ	Pieces / unit		€
441390	black	37 mm	1 pouch	25 / pouch	1/25/500	
441390/301	black	37 mm	1 pack	30 / pack	1/12	
441390/803	black	37 mm	1 bucket	80 / bucket	1	
441390/50-RE	anthracite	37 mm	1 pack	50 / pack	1	



## Clip Insulator Easy Tape

- improved clip mechanism thanks to 2 locking points
- reinforced screw-on plate
- ideal fence line insulator
- screw-on fastening
- suitable for: rope up to Ø 6 mm, tape up to 40 mm

441391/50-RE: plastic made from recycled material with same quality standard

suitable  
wood screws  
442610/1001



patented

Ref. no.	Colour	MOQ	Pieces / unit		€
441391	black	1 pouch	25 / pouch	1/25/500	
441391/251	black	1 pack	25 / pack	1/12	
441391/753	black	1 bucket	75 / bucket	1	
441391/50-RE	anthracite	1 pack	50 / pack	1	



## Corner Insulator

- screw in or nail on

44347: for tapes 40 - 60 mm

44348: for forking fences off in different directions for 40 mm tapes

suitable  
wood screws  
442610/1001



44348



**Important: Not suitable for tapes with copper wires!**

Ref. no.	Description	Colour	MOQ	Pieces / unit		€
44347	without additional bracket	black	1 pouch	10 / pouch	1/10/100	
44348	with spare bracket	black	1 pouch	10 / pouch	1/10/100	

## Insulator Euro Tape

- easy tape installation possible
- with wood thread
- Material: Plastic
- with galvanised support Ø 6 mm
- suitable for: tape up to 40 mm

Ref. no.	Colour	MOQ	Pieces / unit		€
44380	black	1 pouch	25 / pouch	1/25/500	

## Wide Tape Ring Insulator

- with wood thread • Material: Plastic • with galvanised support Ø 6 mm
- suitable for: tape up to 20 mm

Our most popular wide tape ring insulator for 20 mm tapes!

Ref. no.	Colour	MOQ	Pieces / unit		€
44309	black	1 pouch	25 / pouch	1/25/500	
44309/151	black	1 pack	15 / pack	1/14	

## Wide Tape Insulator

- solid and durable type • tape passes through – thus easy straining of hot tape over longer runs of fence • screw in or nail on • Material: Plastic • suitable for: tape up to 40 mm

ideal in combination with corner/stretch insulator

suitable wood screws  
442610/1001

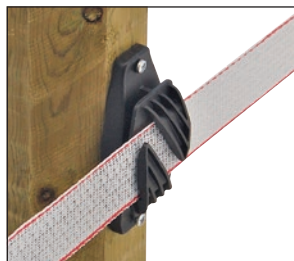

Ref. no.	Colour	MOQ	Pieces / unit		€
44340	black	1 pouch	10 / pouch	1/10/200	
44340/121	black	1 pack	12 / pack	1/12	

## Wide Tape Insulator Compact

- solid and durable type • tape passes through – thus easy straining of hot tape over longer runs of fence • screw in or nail on • Material: Plastic • suitable for: tape up to 20 mm

ideal in combination with corner/stretch insulator

suitable wood screws  
442610/1001

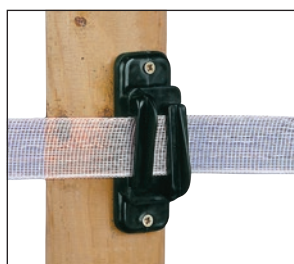

Ref. no.	Colour	MOQ	Pieces / unit		€
44343	black	1 pouch	10 / pouch	1/10/200	



## Rope Insulator Easy Cord

- with wood thread
- Material: impact-resistant plastic
- with galvanised support Ø 6 mm
- suitable for: rope up to Ø 8 mm, Poly Wire

441382/703E: Screw-in Tool Set (item no. 441384) is included with the promotional bucket



10-year UV stability warranty



Ref. no.	Colour	Support Length	MOQ	Pieces / unit		€
441382	black	38 mm	1 pouch	25 / pouch	1/25/500	
441382/301	schwarz	38 mm	1 pack	30 / Blister	1/12	
441382/703E	black	38 mm	1 bucket	70 / bucket	1	

## Rope Insulator Euro Cord

- extremely robust insulator made from break-proof plastic
- screw in or nail on
- for secure fastening of the conductor material
- ideal for fixed fences in combination with TopLine Horse Wire, Premium Horse Wire
- suitable for: Poly Wire, rope up to Ø 8 mm, tape up to 10 mm, TopLine Horse Wire, Premium Horse Wire

ideal for Premium Horse Wire and TopLine Horse Wire

suitable wood screws  
442610/1001

10-year UV stability warranty



Ref. no.	Colour	MOQ	Pieces / unit		€
441396	black	1 pouch	10 / pouch	1/10/200	
441396/200	black	1 pack	200 / pack	1	NEW
441396/201	black	1 pack	20 / pack	1/12	
441396/503	black	1 bucket	50 / bucket	1	



## Permanent Fencing Insulator Highland

- professional insulator for permanent fencing
- ideal for steel wires
- screw in or nail on
- Material: Plastic
- suitable for: Wire, poly wire up to Ø 2.5 mm

suitable wood screws  
442610/1001

10-year UV stability warranty



Ref. no.	Colour	MOQ	Pieces / unit		€
441398	black	1 pouch	10 / pouch	1/10/200	
441398/200	black	1 pack	200 / pack	1	NEW



## Insulator Pinlock

- heavy-duty insulator
- screw in or nail on
- Material: Plastic
- suitable for: steel wire 1.0 - 2.0 mm, Poly Wire, rope up to Ø 8 mm

suitable wood screws  
442610/1001



Ref. no.	Colour	MOQ	Pieces / unit		€
4414951	black	1 pack	25 / pack	1/25/500	



## Corner Insulator Premium

- extra-strong design, highly robust
- polyamide plastic for high tensile forces
- electrical discharges effectively do not arise, partly through the highly insulated post and partly through the special form of the insulator, which prevents the conductor material slipping on the metal support
- with wood thread
- with continuous galvanised support Ø 8 mm
- suitable for: Rope, Poly Wire, Wire, tape up to 10 mm

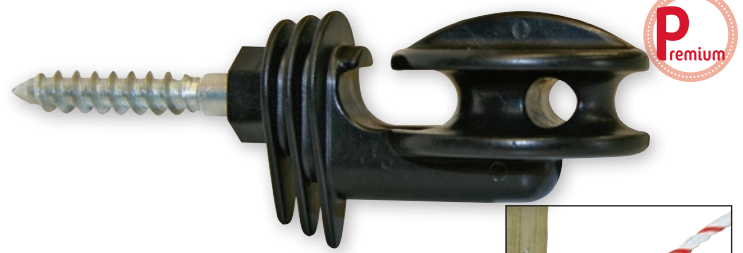

The perfect corner solution

Ref. no.	Colour	MOQ	Pieces / unit		€
441330	black	1 pouch	10 / pouch	1/10/250	
441330/061	black	1 pack	6 / pack	1	

industrial design registered

## Polyamide De-tensioning Insulator for Steel Wire

- suitable as corner and strain insulator in permanent fencing (plain wire)
- Material: polyamide glass-fibre reinforced
- suitable for: Steel Wire, Poly Wire, Rope, Premium Horse Wire, TopLine Horse Wire

resists especially high strains

Ref. no.	Colour	MOQ	Pieces / unit		€
443581	white	1 pouch	10 / pouch	1/10/250	



## De-tensioning Isolator for Electric Rope

- important aid in fence construction
- Material: Polycarbonate
- suitable for: Wire, Poly Wire, Rope

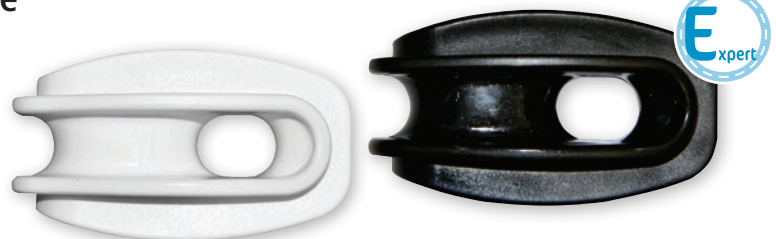

Ref. no.	Colour	MOQ	Pieces / unit		€
443341	white	1 pouch	25 / pouch	1/25/250	
44334/061	white	1 pack	6 / pack	1/50	
443351	black	1 pouch	25 / pouch	1/25/250	



## Corner Insulator for Wire and Rope

- reinforced design
- fully rotatable roll
- with wood thread
- Material: Plastic
- with galvanised support Ø 7 mm
- suitable for: Poly Wire, Rope



Ref. no.	Colour	MOQ	Pieces / unit		€
44330	black	1 pouch	25 / pouch	1/25/250	

# Insulators with metric thread

## Corner Insulator Premium

- extra strong finish made from polyamide plastic (PA)
- no slipping of the conductive material on the metal support thanks to the insulator's special shape
- 2 nuts included
- with metric thread
- with continuous galvanised support  $\varnothing$  8 mm
- suitable for: Rope, Poly Wire, Wire

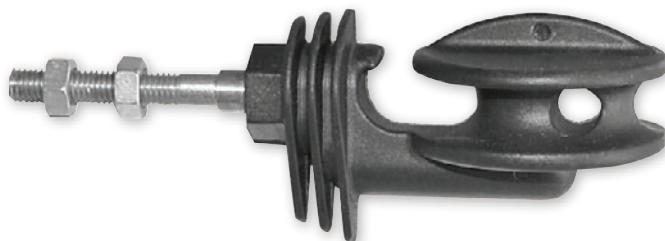

industrial design registered

Ref. no.	Colour	Thread	Thread Length	MOQ	Pieces / unit		€
441360	black	M6	30 mm	1 pouch	10 / pouch	1/10/250	

## Gate Insulator X<sup>3</sup>

- innovative, very robust gate insulator
- galvanised ring with 3 hanging options
- 2 nuts included
- Material: Plastic
- with metric thread
- with galvanised support  $\varnothing$  6 mm



New product

NEW

industrial design registered

Ref. no.	Colour	MOQ	Pieces / unit		€
446561	black	1 pouch	10 / pouch	1/10/250	



## Offset Ring Insulator

- suitable as a spacer
- 2 nuts included
- Material: Plastic
- with metric thread
- with galvanised support  $\varnothing$  6 mm
- suitable for: Poly Wire, Rope, tape up to 10 mm

with short support



Ref. no.	Colour	Support Length	Thread	Thread Length	MOQ	Pieces / unit		€
442376	black	200 mm	M6	100 mm	1 pack	10 / pack	1/10/300	

## Ring Insulator

- 2 nuts included
- Material: Plastic
- with metric thread
- with short galvanised support  $\varnothing$  6 mm
- suitable for: Poly Wire, Rope, tape up to 10 mm



with short support



Ref. no.	Description	Colour	Thread	Thread Length	MOQ	Pieces / unit		€
44324	for Metal Post	black	M6	35 mm	1 pouch	25 / pouch	1/25/500	
44324/201	for Metal Post	black	M6	35 mm	1 pack	20 / pack	1/14	
44391	for tubular pole	black	M6	80 mm	1 pouch	25 / pouch	1/25/500	

## Tape Corner Insulator Cavallo

- extra strong finish made from polyamide plastic (PA)
- free-running tape is fed through safely thanks to smooth, rounded surface
- 2 nuts included
- with metric thread
- with continuous galvanised support  $\varnothing$  8 mm
- suitable for: tape up to 40 mm

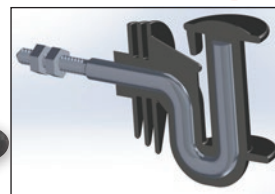
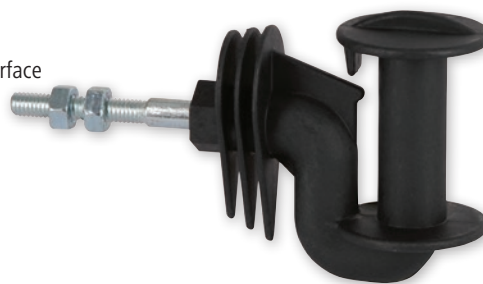

Ref. no.	Colour	Thread	Thread Length	MOQ	Pieces / unit		€
441377	black	M6	30 mm	1 pouch	10 / pouch	1/10/250	

## Gate / Start Insulator

- for attaching gate handles on both sides
- 2 nuts included
- Material: Plastic
- with metric thread
- with galvanised support  $\varnothing$  6 mm



Ref. no.	Colour	Thread	Thread Length	MOQ	Pieces / unit		€
441344	black	M6	25 mm	1 pouch	10 / pouch	1/10/250	

## Clip Insulator

- 2 nuts included
- Material: Plastic
- with metric thread
- with short galvanised support  $\varnothing$  6 mm
- suitable for: rope up to  $\varnothing$  6 mm, tape up to 40 mm

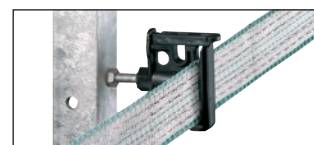
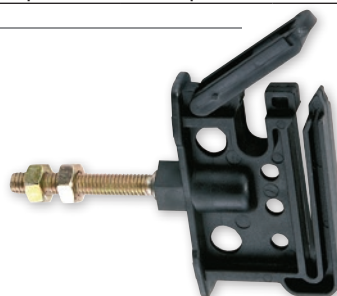

Ref. no.	Colour	Thread	Thread Length	MOQ	Pieces / unit		€
441392	black	M6	35 mm	1 Beutel	25 / pouch	1/25/500	

## Long-handle Clip Insulator

- suitable as a spacer
- 2 nuts included
- Material: Plastic
- with metric thread
- with short galvanised support  $\varnothing$  6 mm
- suitable for: Poly Wire, Rope, tape up to 40 mm

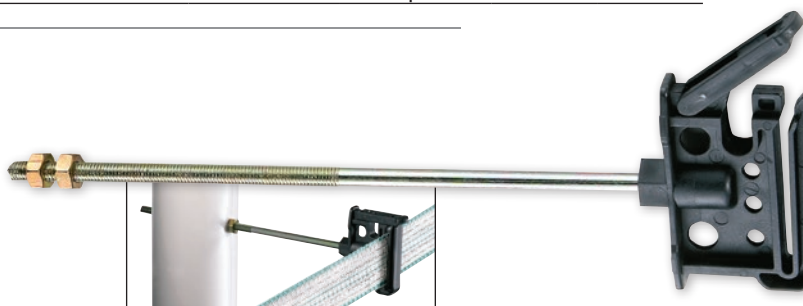

Ref. no.	Colour	Support Length	Thread	Thread Length	MOQ	Pieces / unit		€
441393	black	200 mm	M6	100 mm	1 pouch	10 / pouch	1/10/300	

## Mounting Clamp for round Posts

- for 35 - 70 mm round posts
- incl. rubber inlay to protect the posts
- to fasten insulators with metric thread M6

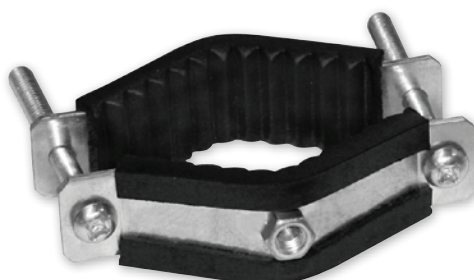

Art. Nr.		€
441276	1/20/120	



## Screw Insulator Vario Plus

- for metal or plastic posts up to  $\varnothing$  17 mm
- mounted on side of post and easily tightened
- heavy-duty quality
- Material: impact-resistant plastic



441386

441387

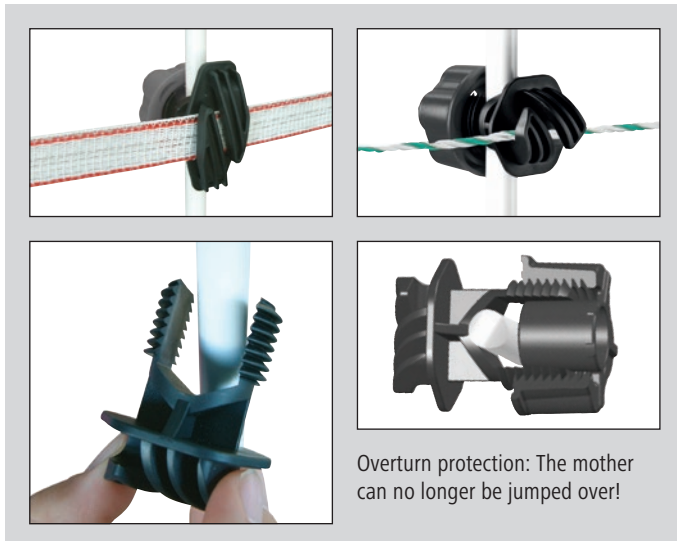

Overturn protection: The mother can no longer be jumped over!

Ref. no.	Description	Colour	MOQ	Pieces / unit		€
441386	for tapes up to 40 mm	black	1 pouch	10 / pouch	1/10/200	
441386/151	for tapes up to 40 mm	black	1 pack	15 / pack	1/22	
441387	for wire, poly wire, rope and 10 mm tape	black	1 pouch	10 / pouch	1/10/200	
441387/201	for wire, poly wire, rope and 10 mm tape	black	1 pack	20 / pack	1/12	

## Ring Insulator Vario Classic

- for metal or plastic posts from 7 to 19 mm diameter
- fast and tool-free installation
- easy to tighten / fix in place by winding the conductor material around the insulator
- Material: impact-resistant plastic
- suitable for: Poly Wire, Rope, tape up to 10 mm





Ref. no.	Colour	MOQ	Pieces / unit		€
445595	black	1 pouch	10 / pouch	1/10/200	
445595/141	black	1 pack	14 / pack	1/22	

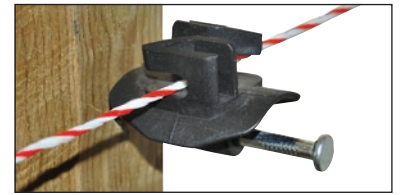
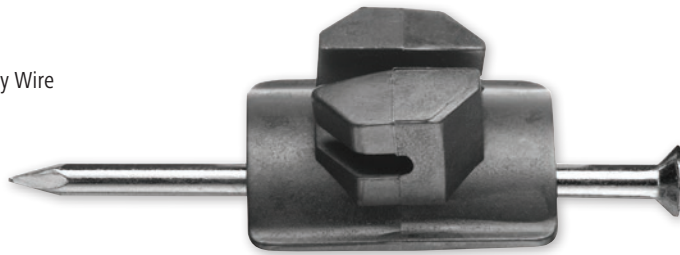

## Nail Insulator

- nail-in
- delivery with nails
- Material: Plastic
- suitable for: Wire, Poly Wire



Ref. no.	Description	Colour	MOQ	Pieces / unit		€
44367	with 7 cm nails	black	1 pouch	50 / pouch	1/50/700	
44368	with 10 cm nails	black	1 pack	50 / pack	1/50/400	

## Nail Insulator

- button shape
- nail-in
- delivery without nail
- Material: Plastic
- suitable for: Wire, Poly Wire

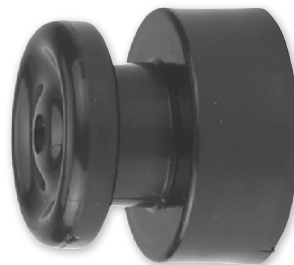

Ref. no.	Colour	MOQ	Pieces / unit		€
44360	black	1 pack	100 / pack	1/100/1800	

## Nail Insulator

- nail-in
- delivery without nail
- Material: Plastic
- suitable for: Wire, Poly Wire

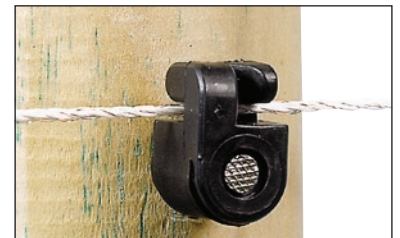

Ref. no.	Colour	MOQ	Pieces / unit		€
44361	black	1 pack	100 / pack	1/100/1800	

## Charge Insulator for round and oval Steel Posts

- simply hammer onto metal/fibreglass poles or structural steel poles (round or oval with a diameter of 6-12 mm) to the desired height and pull in the conductor material
- especially robust and versatile in use
- for hammering
- Material: impact-resistant plastic, UV-stabilised
- suitable for: Poly Wire, Rope, tape up to 20 mm



Ref. no.	Colour	MOQ	Pieces / unit		€
442391	black	1 pack	25 / pack	1/25/200	

## Offset Ring Insulator

- suitable as a spacer
- with wood thread
- Material: Plastic
- with galvanised support  $\varnothing$  6 mm
- suitable for: Poly Wire, Rope, tape up to 10 mm

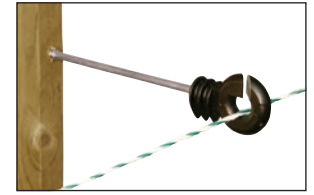

suitable screwdriver 441363/011



Ref. no.	Colour	Support Length	MOQ	Pieces / unit		€
441480	black	22 cm	1 pouch	10 / pouch	1/10/300	

## Offset Ring Insulator

- suitable as a spacer
- with wood thread
- Material: Plastic
- with galvanised support  $\varnothing$  6 mm
- suitable for: Poly Wire, rope up to  $\varnothing$  8 mm, tape up to 10 mm

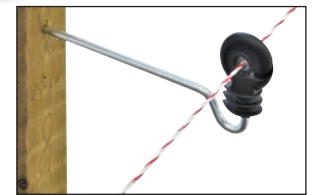

Ref. no.	Colour	Support Length	MOQ	Pieces / unit		€
44310	black	22 cm	1 pouch	10 / pouch	1/10/300	
44310/151	black	22 cm	1 pack	15 / pack	1/12	

## Offset Rope Insulator

- suitable as a spacer
- with wood thread
- Material: Plastic
- with short galvanised support  $\varnothing$  6 mm
- suitable for: Poly Wire, rope up to  $\varnothing$  8 mm, tape up to 10 mm



Ref. no.	Colour	Support Length	MOQ	Pieces / unit		€
44385	black	22 cm	1 pouch	10 / pouch	1/10/200	

## Offset Tape Insulator

- suitable as a spacer
- with wood thread
- Material: Plastic
- with short galvanised support  $\varnothing$  6 mm
- suitable for: tape up to 20 mm

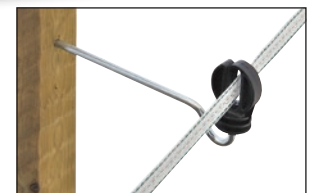

Ref. no.	Colour	Support Length	MOQ	Pieces / unit		€
44312	black	22 cm	1 pouch	10 / pouch	1/10/300	
44312/151	black	22 cm	1 pack	15 / pack	1/12	

## Long-handle Clip Insulator

- suitable as a spacer
- with wood thread
- Material: Plastic
- with galvanised support  $\varnothing$  6 mm
- suitable for: Poly Wire, rope up to  $\varnothing$  6 mm, tape up to 40 mm



suitable screwdriver 441363/011



Ref. no.	Colour	Support Length	MOQ	Pieces / unit		€
441395	black	20 cm	1 pouch	10 / pouch	1/10/300	
441395/151	black	20 cm	1 pack	15 / pack	1/12	

## Insulator for double Wire Mesh Fence

- for the stem electrification of a wire mesh fence
- for deterring unwanted intruders such as martens, raccoons, cats, etc.
- easy and tool-free mounting
- made from weather-resistant plastic
- suitable for: Poly Wire, Rope, tape up to 10 mm



Ref. no.	Colour	Length	Width	Height	MOQ	Pieces / unit		€
442389	black	11.5 cm	7 cm	2.5 cm	1 pack	10 / pack	1/14	

## Distance Insulator

- for the stem electrification of mesh wire or knotted wire fences
- simply fit onto the round fence posts
- for deterring unwanted intruders such as wolves, wild boar
- made from weather-resistant plastic
- Support Length: 25 cm
- suitable for: Poly Wire, Rope, tape up to 10 mm

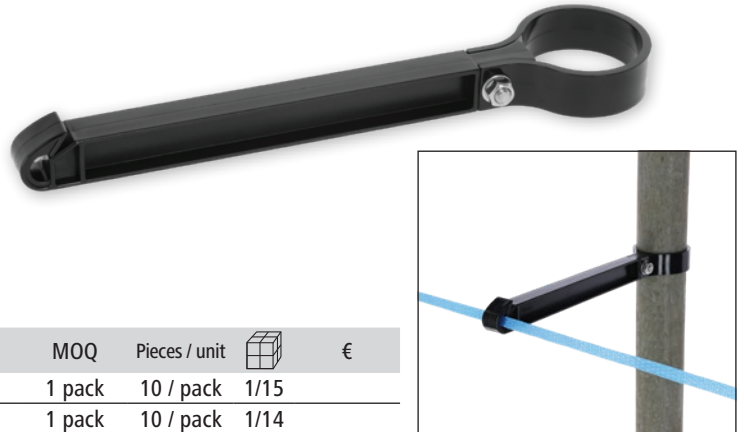

Ref. no.	Description	Colour	MOQ	Pieces / unit		€
442379	for round posts $\varnothing$ 48 mm	black	1 pack	10 / pack	1/15	
442388	for round posts $\varnothing$ 60 mm	black	1 pack	10 / pack	1/14	

## Stem Eyelet Insulator

- plastic  $\varnothing$  12 mm, support  $\varnothing$  6 mm
- nail on with staples 44394 (not included)
- Material: metal, plastic-coated
- suitable for: Poly Wire, Rope, tape up to 40 mm

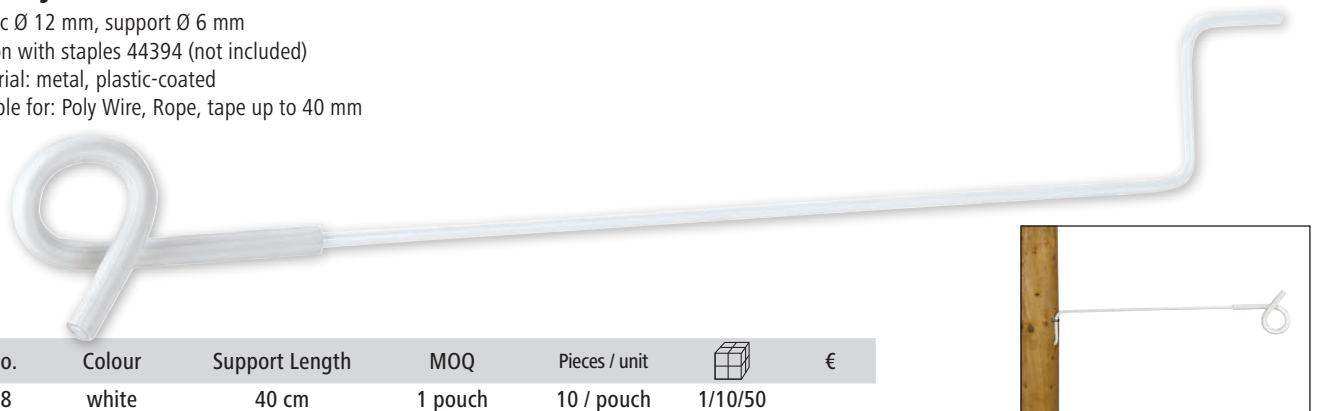

Ref. no.	Colour	Support Length	MOQ	Pieces / unit		€
44448	white	40 cm	1 pouch	10 / pouch	1/10/50	

## Offset Pigtail Insulator

- suitable as a spacer
- plastic  $\varnothing$  12 mm, galvanised support  $\varnothing$  7 mm
- with wood thread
- suitable for: Poly Wire, Rope, tape up to 40 mm

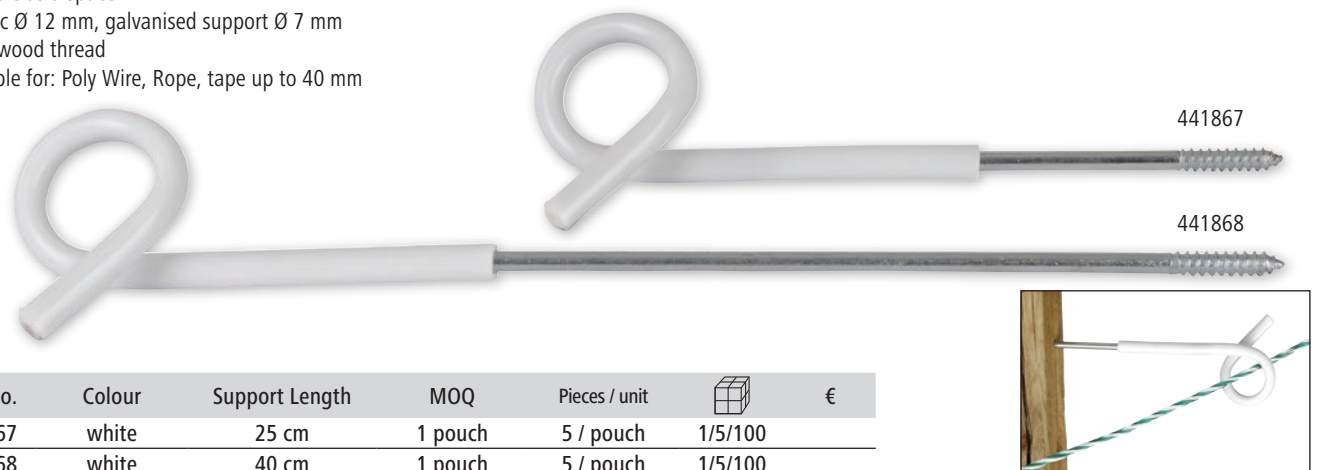

Ref. no.	Colour	Support Length	MOQ	Pieces / unit		€
441867	white	25 cm	1 pouch	5 / pouch	1/5/100	
441868	white	40 cm	1 pouch	5 / pouch	1/5/100	



## Gate Insulator X<sup>3</sup> Premium

- innovative, very robust Premium Gate Insulator
- Stainless steel ring with 3 hanging options
- with wood thread
- Material: Plastic
- with galvanised support Ø 6 mm



industrial design registered  
Stainless Steel Ring



Ref. no.	Colour	MOQ	Pieces / unit		€
446550	blue	1 pouch	10 / pouch	1/10/250	
446550/061	blue	1 pack	6 / pack	1/50	

## Gate / Start Insulator Premium Vario

- incl. connecting plate made of stainless steel
- with 3 connection options for the gate handle
- ideal as starting insulator, e.g. after a gate
- screw-on fastening

5-year UV stability warranty



professional version larger and made from extremely robust polycarbonate

Stainless steel connecting plate



Ref. no.	Colour	Hole spacing	MOQ	Pieces / unit		€
446545/041	blue	94 mm	1 pack	4 / pack	1/14	

## Gate / Start Insulator Vario

- incl. connecting plate made of stainless steel
- fiberglass reinforced
- connecting plates each with 3 connection options for gate handles
- ideal as starting insulator, e.g. after a gate
- screw-on fastening
- Material: polyamide glass-fibre reinforced

also ideal for use as a starting insulator  
Stainless steel connecting plate



Ref. no.	Colour	Lochabstand	MOQ	Pieces / unit		€
44237/021	black	70 mm	1 pair	2 / pack	1/50	

suitable wood screws 442610/1001



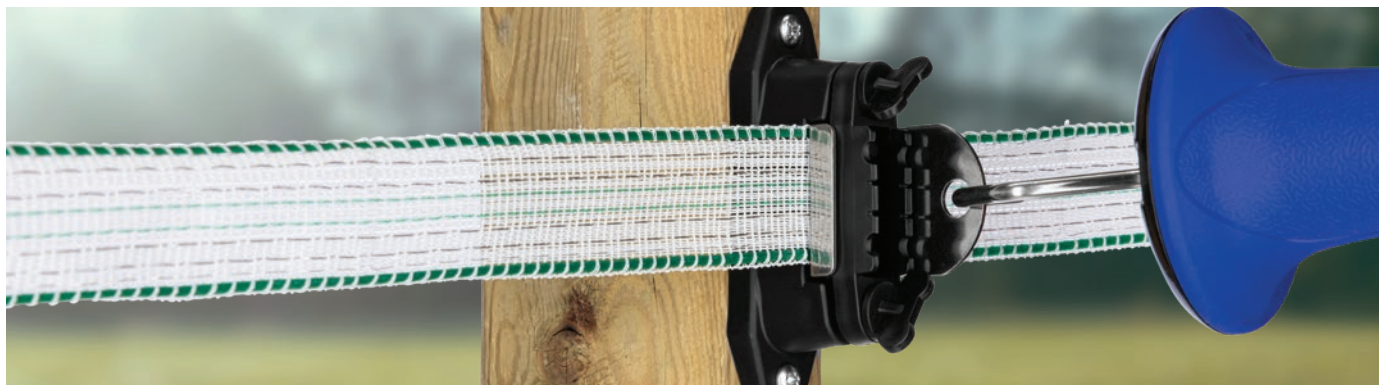



## Combi Insulator Premium

for gates at corners and T-separations

- with robust stainless steel connection plate for mounting gate handles
- enables the simple creation of T-separations on the line post -> the conductor material can continue to run behind the stainless steel plate and does not have to be interrupted
- excellent electrical contact guarantees maximum conductivity between the conductor material and the gate handle
- can also be used ideally as a corner insulator with subsequent gate
- universally applicable for tape, rope and wire
- conductor material can be retensioned very easily
- screw in or nail on

also ideal for use as a starting insulator  
Stainless steel connecting plate

Ref. no.	Colour	MOQ	Pieces / unit		€
446555/031	black	1 pack	3 / pack	1/20	

Ref. no.	Description	Material	MOQ	Pieces / unit		€
443456	Replacement Connection Plate	Stainless Steel	10 pieces	10 / pouch	1/10/400	





## Gate / start Insulator for Tapes Premium

- a robust tape insulator with stainless steel connecting plate for gate handle and pasture fence connection
- ideal as starting insulator, e.g. after a gate
- Material: Plastic
- suitable for: tape up to 40 mm

also ideal for use as a starting insulator

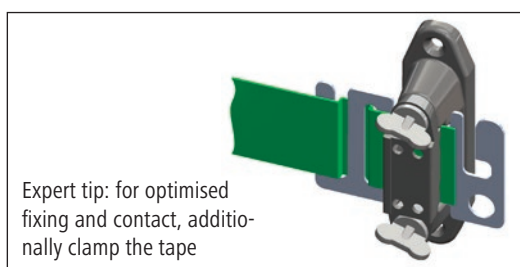
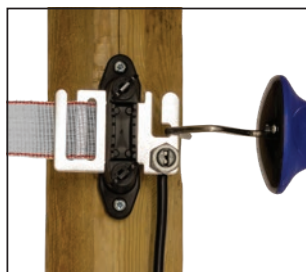
Stainless steel connecting plate



Ref. no.	Colour	MOQ	Pieces / unit		€
44355/041	black	1 pack	4 / pack	1/22	

Ref. no.	Description	Material	MOQ	Pieces / unit		€
443453	Replacement Connection Plate for Start Tape Insulator Premium	Stainless Steel	10 pieces	10 / pouch	1/10/360	

suitable wood screws 442610/1001





## Gate Insulator X<sup>3</sup>

- innovative, very robust gate insulator
- galvanised ring with 3 hanging options
- with wood thread
- Material: Plastic
- with galvanised support Ø 6 mm



Geschmacksmuster eingetragen

Ref. no.	Colour	MOQ	Pieces / unit		€
446560	black	1 pouch	10 / pouch	1/10/250	
446560/061	black	1 pack	6 / pack	1/50	

## Gate Insulator

- for attaching gate handles on both sides
- practical and secure
- 360° rotatable hanging loop
- with wood thread
- with galvanised support

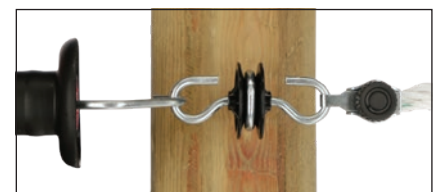

**Important: Not suitable for conductor material with copper wires!**

Ref. no.	Colour	MOQ	Pieces / unit		€
44248	black	1 pouch	10 / pouch	1/10/250	

## Quick Rope/Poly Wire Connector

- allows ropes, wires and tapes of up to 10 mm to be connected to gate insulators and handles quickly and easily, resulting in a connection with optimal electrical conductivity
- can be mounted without tools



patented



For secure fixing of stranded wires, we recommend wrapping the conductor material around the screw several times to prevent it from slipping out.

The benefits: No need for tools, easy to create an optimum electrical connection using fixing screws. Also ideally suitable for retightening.



Ref. no.	Material	can be used for	MOQ	Pieces / unit		€
441209/041	galvanised metal	Poly Wire, rope up to Ø 8 mm, tape up to 10 mm	1 pack	4 / pack	1	



## Gate / Tensioning Isolator TITAN

for gate use and the simultaneous tensioning of the conductor material

- flexibly usable insulator with stainless steel connection plate for mounting gate handles
- ideal initial/final insulator for gates - gate handle is hooked in and directly electrically contacted
- extremely robust thanks to glass fibre-reinforced polyamide
- conductor material can be retensioned very easily and safely by hand using the snap-in function
- screw-on fastening
- suitable for: tape up to 40 mm



also ideal for use as a starting insulator  
Stainless steel connecting plate

Set includes: 3 x premium insulator TITAN, 3 x stainless steel connecting plate

Ref. no.	Colour	MOQ	Pieces / unit		€
446578/031	black	1 pack	3 / pack	1/25	

## Quick Rope/Poly Wire Connector

- allows ropes, wires and tapes of up to 10 mm to be connected to gate insulators and handles quickly and easily, resulting in a connection with optimal electrical conductivity
- made from stainless steel, guaranteeing excellent corrosion resistance
- can be mounted without tools



For secure fixing of stranded wires, we recommend wrapping the conductor material around the screw several times to prevent it from slipping out.

patented

Stainless Steel

The benefits: No need for tools, easy to create an optimum electrical connection using fixing screws. Also ideally suitable for retightening.



Ref. no.	Material	can be used for	MOQ	Pieces / unit		€
441285/041	Stainless Steel	Poly Wire, rope up to Ø 8 mm, tape up to 10 mm	1 pack	4 / pack	1	

# Gate Handles with Tension Limiter

- with tension limiter to prevent over-stretching of the spring
- Heavy-duty quality
- UV-stabilised plastic
- excellent insulation
- Tension limiter

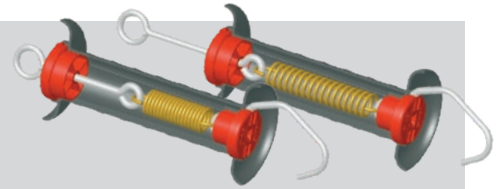



## Gate Handle Premium

- very robust and durable gate handle, thanks to screwed sealing cap
- hook and eyelet made from non-rusting stainless steel – ensures excellent corrosion resistance
- special surface structure and very large grip surface give the gate handle an innovative look and pleasant feel
- Material: plastic, UV-stabilised
- with tension limiter

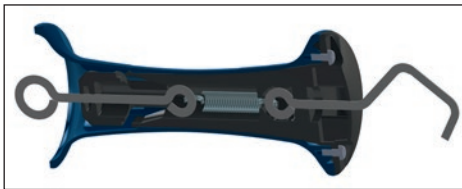

Hook and eyelet made from non-rusting stainless steel



Ref. no.	Colour	MOQ	Pieces / unit		€
44991	blue	5 pieces	5 / pouch	1/5/50	

## Gate Handle Soft Grip

- very resistant and flexible plastic
- break-proof, even during frost
- galvanised hook and eyelet
- Material: plastic, UV-stabilised
- with tension limiter



Ref. no.	Colour	MOQ	Pieces / unit		€
44973	black	1 pouch	5 / pouch	1/5/100	

## Gate Handle

- hanging hook closed
- galvanised hook and eyelet
- Material: plastic, UV-stabilised
- with tension limiter



Ref. no.	Colour	MOQ	Pieces / unit		€
44940	black	1 pack	5 / pack	1/5/100	

## Gate Handle

- galvanised hook and eyelet
- Material: plastic, UV-stabilised
- with tension limiter



**Top Seller**

Ref. no.	Colour	MOQ	Pieces / unit		€
44941	black	1 pack	5 / pack	1/5/100	

## Gate Handle Premium BIG green

- gate handle made of sustainable bio-based plastic - from 100 % renewable raw materials
- wood look thanks to small natural wood chips in the bio-plastic
- tapered grip surface for a pleasant feel
- packaging made from 100 % recycled cardboard
- galvanised hook and spring



Made in Germany



Ref. no.	Colour	MOQ	Pieces / unit		€
44977	brown	1 box	20 / box	1/20	

## Gate Handle

- plastic made from recycled material with same quality standard
- galvanised hook and spring
- with simple tension spring



Ref. no.	Colour	MOQ	Pieces / unit		€
44981-RE	anthracite	1 box	20 / box	1/20	

## Gate Handle

- galvanised hook and spring
- Material: plastic, UV-stabilised
- with simple tension spring



Ref. no.	Colour	MOQ	Pieces / unit		€
44951	black	1 pack	5 / pack	1/5/100	
44957	pink	1 pack	5 / pack	1/5/100	
44958	neon purple	1 pack	5 / pack	1/5/100	
44959	neon green	1 pack	5 / pack	1/5/100	
44960	neon orange	1 pack	5 / pack	1/5/100	
44953	yellow	1 pack	5 / pack	1/5/100	
44961	petrol	1 pack	5 / pack	1/5/100	

## Gate Handle Premium with Litzclip® Tape Connector

- high-quality, premium class gate handle in combination with the Litzclip® tape connection
- hook and eyelet made from non-rusting stainless steel – ensures excellent corrosion resistance
- Material: plastic, UV-stabilised
- with tension limiter



Ref. no.	Colour	Connector	Pieces / unit		€
4499120	blue	20 mm	5 / pouch	1/5/50	
4499140	blue	40 mm	5 / pouch	1/5/50	

## Gate Handle with Litzclip® Tape Connector

- with Litzclip® stainless steel tape connector
- galvanised hook and eyelet
- Material: plastic, UV-stabilised
- with tension limiter

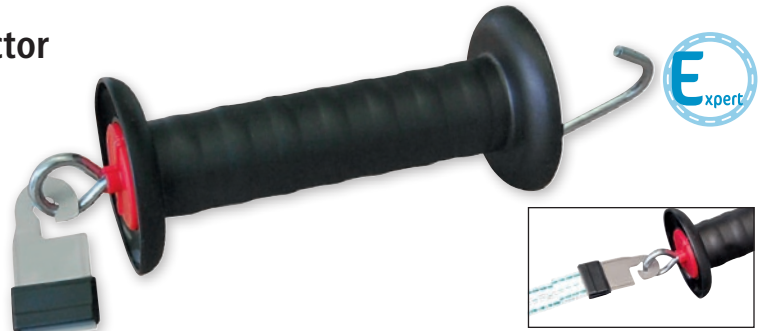

Ref. no.	Colour	Connector	MOQ	Pieces / unit		€
4494120	black	with Litzclip® stainless steel tape connector 20 mm	1 pack	5 / pack	1/5/100	
4494140	black	with Litzclip® stainless steel tape connector 40 mm	1 pack	5 / pack	1/5/100	

## Gate Handle with Litzclip® Connector

- with Litzclip® stainless steel rope connector
- galvanised hook and eyelet
- Material: plastic, UV-stabilised
- with tension limiter



Ref. no.	Colour	Connector	MOQ	Pieces / unit		€
44969	black	with Litzclip® stainless steel rope connector 6 mm	1 pack	5 / pack	1/5/100	
44972	black	with Litzclip® stainless steel poly wire connector 3 mm	1 pack	5 / pack	1/5/100	

## Tape Gate Handle Connector Litzclip®

- The tool-free gate handle connectors for 10, 20 and 40 mm fence tapes extend our patented, successful Litzclip® range.
- The connectors are self-evident in their function and can be very easily and quickly fitted to any gate handle or gate insulator.



Made in Germany



patented

Ref. no.	Material	can be used for	MOQ	Pieces / unit		€
442006/041	Stainless Steel	tape up to 20 mm	1 pack	4 / pack	1/100	
442007/041	Stainless Steel	tape up to 40 mm	1 pack	4 / pack	1/100	



## Gate Handle Premium with Rope and Wire Connector

- high-quality, premium class gate handle in combination with the matching rope / wire quick connector
- hook and eyelet made from non-rusting stainless steel – ensures excellent corrosion resistance
- also suitable for tapes from 10 to 20 mm
- with tension limiter

The benefits: No need for tools, easy to create an optimum electrical connection using fixing screws. Also ideally suitable for retightening.



Ref. no.	Colour	Pieces / unit		€
4499185	blue	5 / pouch	1/5/50	

Ref. no.	Description	Material	MOQ	Pieces / unit		€
441285/041	Quick Rope/Poly Wire Connector	Stainless Steel	1 pack	4 / pack	1	

## Gate Handle with Rope and Wire Connector

- Gate handle incl. rope and polywire connector (already fixed to the gate handle)
- also suitable for tapes from 10 to 20 mm
- galvanised hook and eyelet
- Material: plastic, UV-stabilised
- with tension limiter



The benefits: No need for tools, easy to create an optimum electrical connection using fixing screws. Also ideally suitable for retightening.

Ref. no.	Colour	MOQ	Pieces / unit		€
44948	black	1 pack	5 / pack	1/5/100	



Ref. no.	Description	Material	MOQ	Pieces / unit		€
441209/041	Quick Rope/Poly Wire Connector	galvanised metal	1 pack	4 / pack	1	

## Gate Handle with Tape Connector

- with tape connector
- galvanised hook and eyelet
- Material: plastic, UV-stabilised
- with tension limiter



**Important: Not suitable for tapes with copper wires!**

Ref. no.	Colour	Connector	MOQ	Pieces / unit		€
44947	black	with tape connector 40 mm	1 pack	5 / pack	1/5/100	

## Fence Clip

- for attaching gate handles when gate is open
- avoids dangerous trip hazards and contamination of conductor material and gate handle
- no power leakage any more from conductor material lying on the ground
- suitable for fencing tape to max. 40 mm width, ropes to 8 mm diameter, and wires
- Material: Plastic

Made in Germany

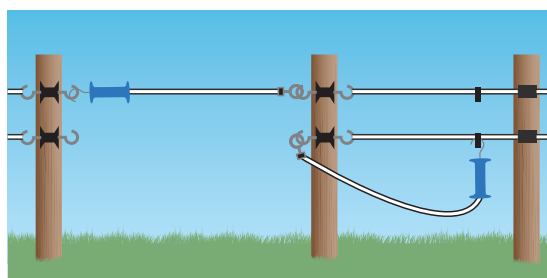

Ref. no.	MOQ	Pieces / unit		€
442371	1 pack	8 / pack	1	



Especially suitable for horse paddocks! End-to-end electrical contact!  
integrated retraction brake ensures controlled retraction of the conductor material and prevents injuries and damage

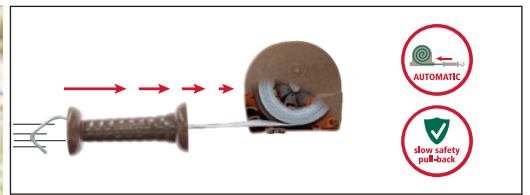

## Gate Set Premium FLEXIGATE green

Innovative technology, sustainable material and a new look - our new flexible gate system for paddock entrances up to 6 m wide

- housing and gate handle made of sustainable bio-based plastic - from 100 % renewable raw materials
- wood look thanks to small natural wood chips in the bio-plastic
- robust housing in a compact and modern design
- connection cable included in the scope of delivery enables ideal contacting and continuous electrification of the gate
- easy and quick mounting on the post by means of enclosed wood screws
- high-quality conductor material with our proven TriCond wires ensures maximum conductivity throughout - available with 40 mm wide tape or 6 mm rope
- the orientation of the 40 mm wide tape can be rotated by 90 degrees in the gate handle and can thus be individually adapted to the hanging direction of the gate handle -> wide tape is always upright and can thus be perceived better
- extendable up to 6 m in length
- can be mounted on both sides (opening to the left or right)



Scan the QR code for the video and discover the advantages of the Flexi-Gate Premium green!

Made in Germany



patented

Included in Delivery: 1 x FLEXIGATE green, 1 x connection cable (40 cm) with ribbon or cable connector for optional electrification, 2 x wood screws for mounting on the post

Ref. no.	Description	Colour		€
442398	with 40 mm tape	brown	1	
442399	with 6 mm rope	brown	1	

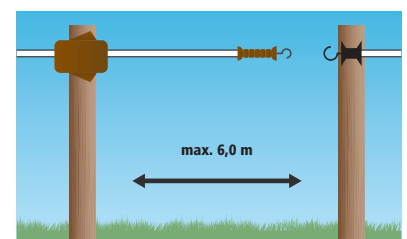



## FlexiGate 19 m

### The flexible barrier system

This system provides you with easy subdivision, closing of individual paddocks, and the guided herding of your animals (e.g. from the stable to the pasture).

- conductor material: optimal current output via 9 strong stainless steel conductors ensures the highest tending safety at the gate
- high quality workmanship
- increased fracture load thanks to strong monofilament wires
- fastening 1: with 2 included wooden screws directly to the wooden post or wall
- fastening 2: with the included hinge

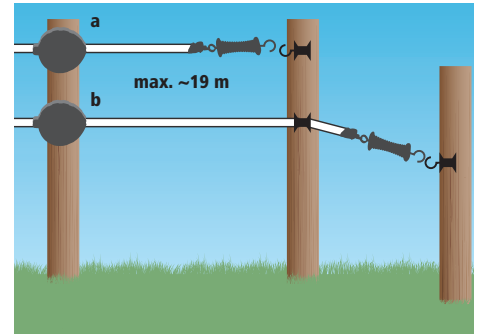

Ref. no.	Description	Colour	max. passage width	MOQ	Pieces / unit		€
441294	with 20 mm tape	black	19 m	1 pack	1 / pack	1/5	

## FlexiGate

### the Flexible Gate System

Flexigate makes it easy for you to electrify paddock entrances. On opening the conductor material will be reeled up automatically by a steel spring.

- secured with 2 included wooden screws DIRECTLY to the wooden post
- no sagging of tapes or ropes
- no stumbling for humans and animals
- no catching of mane or tail hair
- no soiling of conductor material
- end-to-end electrical contact
- connecting cable not included



Especially suitable for horse paddocks! End-to-end electrical contact!

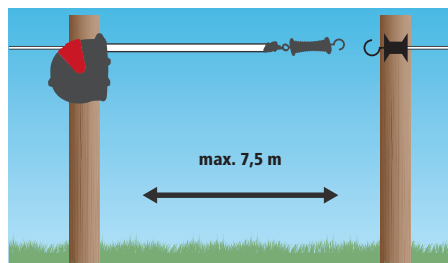

Ref. no.	Description	Colour	max. passage width	MOQ	Pieces / unit		€
441298/011	with 40 mm tape	black / red	- 7.5 m	1 pack	1 / pack	1/9	
441299/011	with 6 mm rope	black / red	- 7.5 m	1 pack	1 / pack	1/9	

Ref. no.	Description	Colour	MOQ	Pieces / unit		€
44617/011	Tape Connecting Cable	red	1 pack	1 / pack	1/90	
44627/011	Rope Connecting Cable	red	1 pack	1 / pack	1/90	

## Gate Lock

### the lockable gate system

Hook the gate handle into the connector plate – push the safety cover to – lock the padlock – done! This firmly anchors the gate handle in the locked safety housing and only authorised persons can enter the pasture.

Set consisting of: 1 x safety waistcoat, two-part: Wall or post attachment + safety cover, 1 x gate insulator with strong plastic and stainless steel mounting plate, 1 x gate handle with spring tension limiter, 2 x mounting screws, 1 x brass padlock with 2 keys

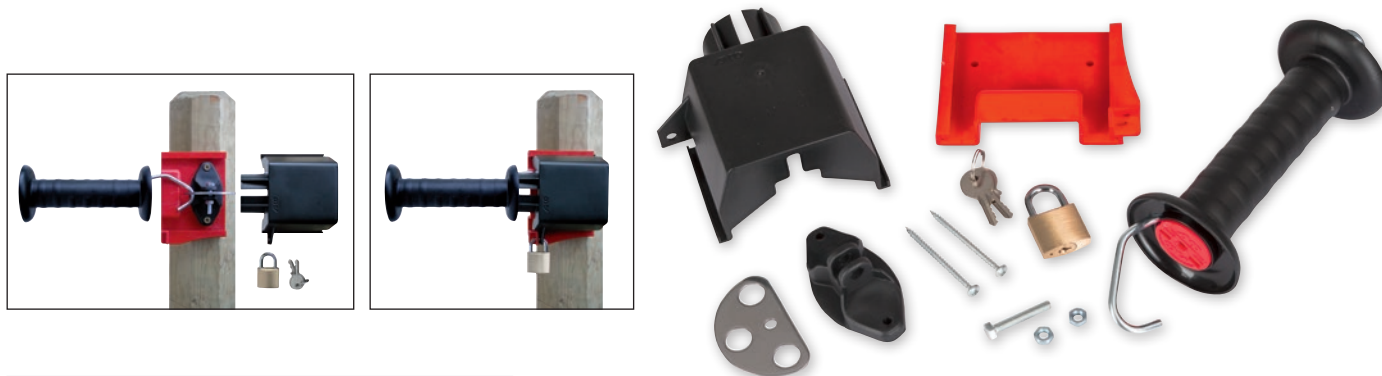

Ref. no.	Farbe		€
441235	black	1	

## Gate Spring Kit

- stretchable up to 5 metres

Set consisting of: 1 x gate handle with hook, 1 x galvanised special spring, 2 x insulators

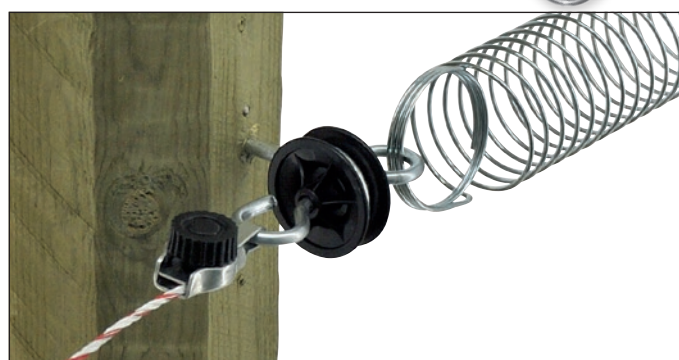
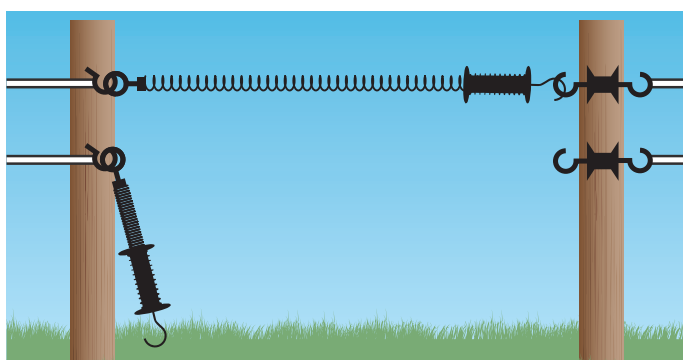
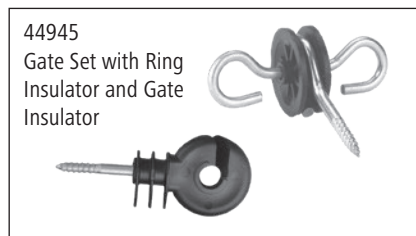
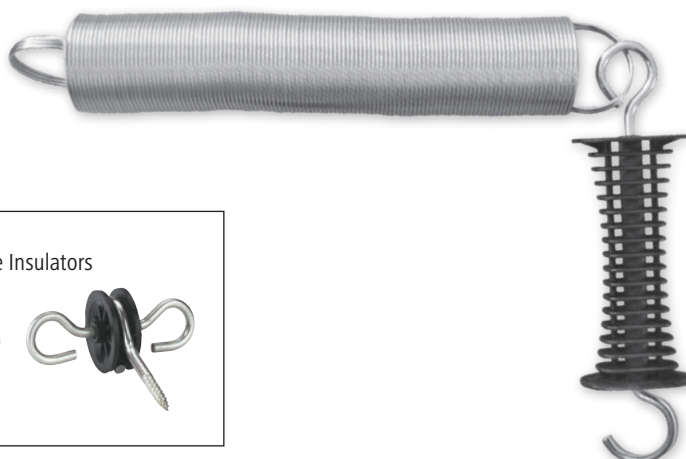

Not suitable for horse fencing!

Ref. no.	Description	Colour	Elasticity	Pieces / unit		€
44945/011	incl. 2 gate insulators	black	5 m	1 / pack	1/12	
44945	incl. ring and gate insulator	black	5 m		1/15	

Ref. no.	Description	Material	MOQ	Pieces / unit		€
44246	Spare Spring for Gate Spring Kit	galvanised metal			1/20	
441209/041	Quick Rope/Poly Wire Connector	galvanised metal	1 pack	4 / pack	1	

## Gate System E-Line

The original E-Line System 'Made in the EU' for maximum quality requirements

- with conducting elastic rope
- very practical and handy electric fence door for fence openings
- no catching of mane or tail hair
- with stainless steel hook
- correct assembly of the gate system through the use of 3 gate posts
- can be extended to around twice the length

Set consisting of: 1 x Ø 7 mm electric fencing rope (3 years warranty), with 4 x 0.25 mm stainless steel conductors, with connector hook, 1 x sturdy gate handle, 1 x ring insulator, 1 x gate insulator

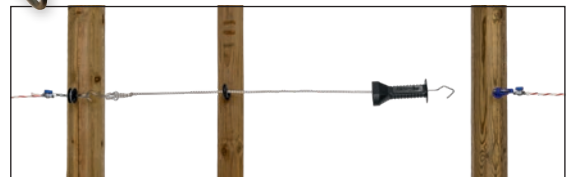

Especially suitable for horse paddocks!

Ref. no.	Elasticity	MOQ	Pieces / unit		€
44255/011	3 - 6 m	1 pack	1 / pack	1/14	
442551/011	4.5 - 9 m	1 pack	1 / pack	1/14	

## Gate System Eco

inexpensive FlexiRope Gate Handle Set

- with conducting elastic rope
- can be extended to around twice the length
- no catching of mane or tail hair

Set consisting of: 1 x gate handle, 1 x current-carrying, 7 mm elastic rope with 3 x 0.30 mm stainless steel conductors, 2 x rope connectors, 1 x ring insulator, 2 x gate insulators



Ref. no.	Colour	Elasticity		€
4418651	white / black	3 - 6 m	1/15	
4418661	white / black	4.5 - 9 m	1/15	

Ref. no.	Description	Length		€
441890	Rubber Electric Rope	25 m	1/12	
441891	Rubber Electric Rope	50 m	1/6	









## Electric Cattle Gate Electro Gate

- powered by fences and easy to integrate in already installed fence systems
- the flexible fibre-glass sticks are covered with electrically conductive rubber
- insulated gate handles for pedestrians
- the physical law of the Faraday cage protects the driver against electric shocks
- opens in both directions and self-closing behind
- lockable in open position

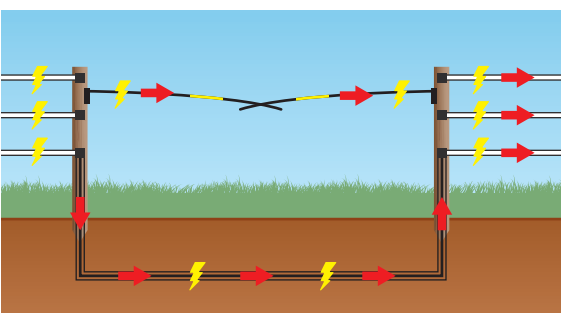
44283: 1 rod, 1 hinge, 1 x insulated ground cable

Set consisting of: 2 x stick, 2 x hinges, 1 x insulated ground cable



Ref. no.	Colour	max. passage width		€	
441287	black	6 m	1		
44282	black	5 m	1		
44281	black	3.6 m	1		
44283	black	1.2 m	1		

Ref. no.	Description	Colour	Material	Length		€
441288	Spare Rod Electro Gate	black	Fibreglass	3 m	1	
44285	Spare Rod Electro Gate	black	Fibreglass	2.5 m	1/50	
44284	Spare Rod Electro Gate	black	Fibreglass	1.8 m	1/50	
44286	Spare Hinge Electro Gate				1/125	

## Pasture Gate adjustable

- stable galvanised steel pasture gate

Included in Delivery: 1 x Pasture Gate, 2 x hinges, 1 x locking facility, 6 x wood screws (12 x 80 mm)



The hinge installation set can be compensated by adjusting the threaded hinge bolts.



Can be extended with an adjustable set screw



Closing option available (without lock)  
• optional padlock for locking

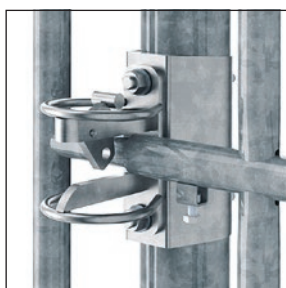
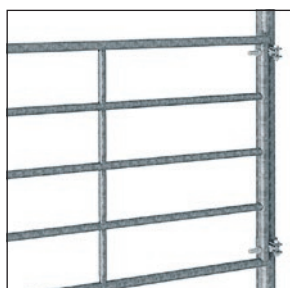
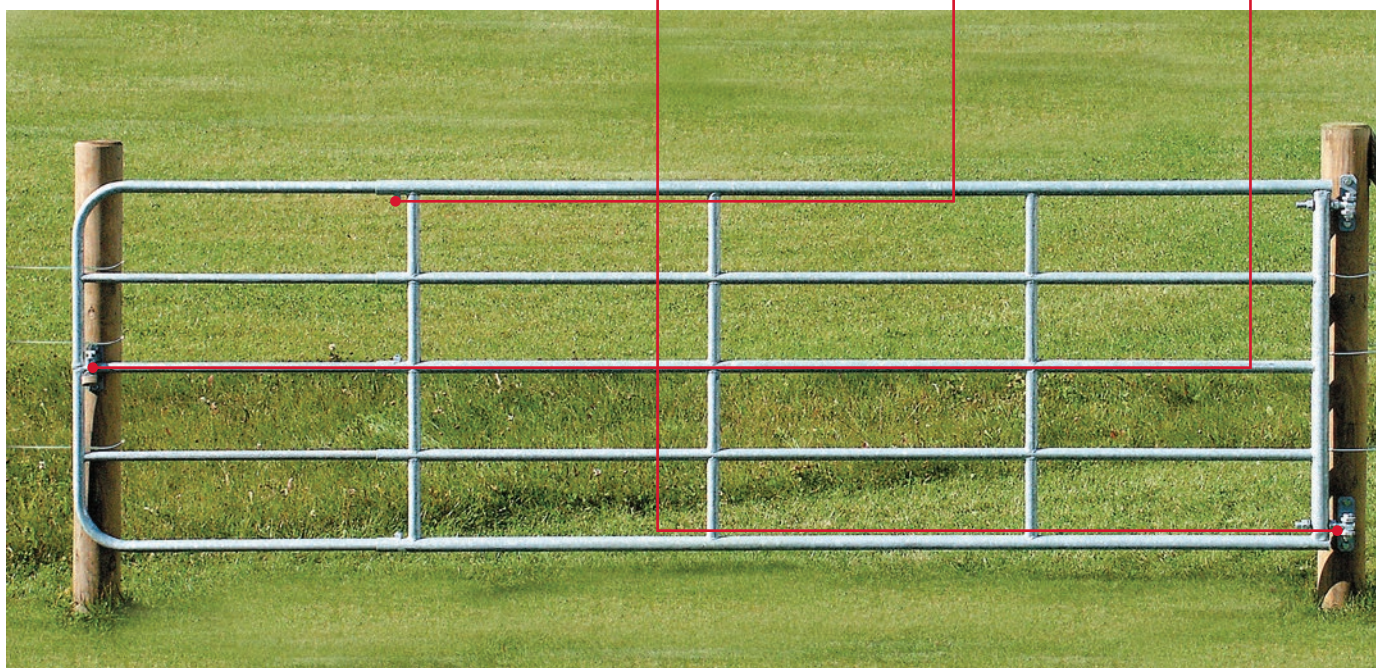

The hinge installation set can be compensated by adjusting the threaded hinge bolts (freely height-adjustable).

Closing option available (without lock)



442578



442579

Ref. no.	Description	Adjustability	Height	Material		€	
44893	Pasture Gate adjustable	1 - 1.7 m	110 cm	steel, hot-dip galvanised	1		
44892	Pasture Gate adjustable	2 - 3 m	110 cm	steel, hot-dip galvanised	1		
44891	Pasture Gate adjustable	3 - 4 m	110 cm	steel, hot-dip galvanised	1		
44895	Pasture Gate adjustable	4 - 5 m	110 cm	steel, hot-dip galvanised	1		
442557	Pasture Gate adjustable	5 - 6 m	110 cm	steel, hot-dip galvanised	1		

Ref. no.	Description	Material	Length	Ø		€	
442577	Gate Post for Pasture Gate with plastic cap	hot-dip galvanised metal	2 m	88 mm	1		
442578	Lock Catch for Gate Post	hot-dip galvanised metal			1		
442579	Hinge Pin Bracket (in pairs) for Gate Post	hot-dip galvanised metal			1		
442940	Locking Bar for Pasture Gate	hot-dip galvanised metal			1		

Please note separate freight costs.



## Pasture Gate adjustable

- stable galvanised steel pasture gate

442904:

- NEW: our tried-and-tested, 90-cm-high adjustable pasture gates are also available as a compact version with a flexible width from 1.0 - 1.7 m

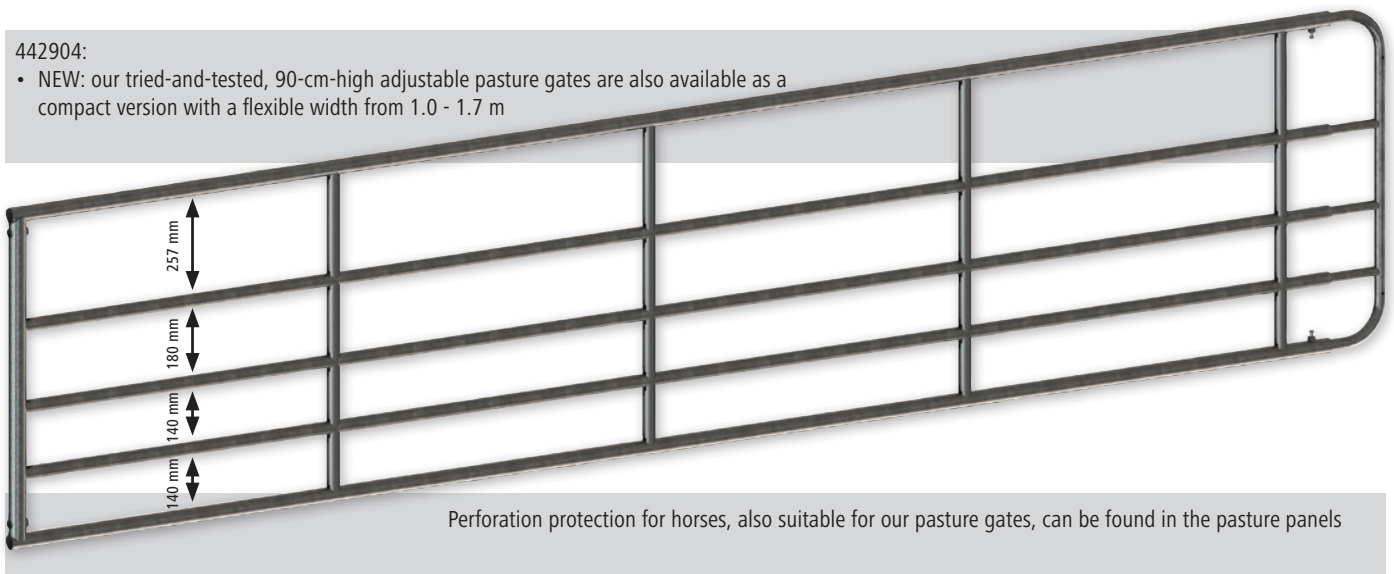





Perforation protection for horses, also suitable for our pasture gates, can be found in the pasture panels



Included in Delivery: 1 x Pasture Gate,  
2 x hinges, 1 x locking facility, 6 x  
wood screws (12 x 80 mm)

Please note separate freight costs.

442940



Ref. no.	Description	Adjustability	Height	Material	 	€
442904	Pasture Gate adjustable	1 - 1.7 m	90 cm	steel, hot-dip galvanised	1 40	
442900	Pasture Gate adjustable	2 - 3 m	90 cm	steel, hot-dip galvanised	1 50	
442901	Pasture Gate adjustable	3 - 4 m	90 cm	steel, hot-dip galvanised	1 23	
442902	Pasture Gate adjustable	4 - 5 m	90 cm	steel, hot-dip galvanised	1 23	

Ref. no.	Description	Material	Length	Ø		€
442577	Gate Post for Pasture Gate with plastic cap	hot-dip galvanised metal	2 m	88 mm	1	
442578	Lock Catch for Gate Post	hot-dip galvanised metal			1	
442579	Hinge Pin Bracket (in pairs) for Gate Post	hot-dip galvanised metal			1	
442940	Locking Bar for Pasture Gate	hot-dip galvanised metal			1	



## Pasture Gate adjustable for Horse Owners

- robust and durable safety for your horses at gates and passageways
- especially stable design that complies with the relevant horse care directives with its product dimensions
- the clear widths between the tubes are configured in such a way that horses cannot become dangerously trapped in the gate and then no longer be able to free themselves
- the supplied spacer tube and spacer bar prevent horses from getting into the dangerously narrow space between the gate and suspension or jumping up and injuring themselves
- Hexagon socket screws in the clamping brackets further reduce the risk of injury
- stable, hot-dip galvanised steel pasture gate

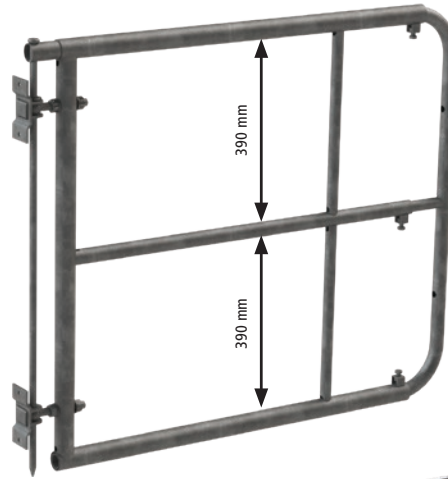

Complies with the applicable directives for horse husbandry

Included in Delivery: 1 x Pasture Gate, 1 x spacer pipe, 1 x intermediate space rod, 2 x hinges, 1 x locking facility, 6 x wood screws (12 x 80 mm)

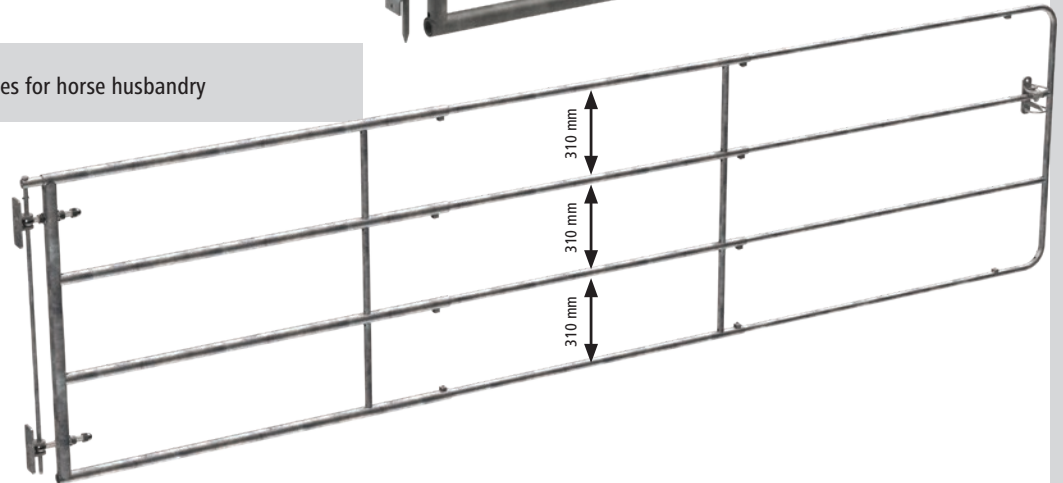

Ref. no.	Description	Adjustability	Height	Material		€
442910	Pasture Gate adjustable for Horse Owners	1 - 1.7 m	90 cm	steel, hot-dip galvanised	1	40
442916	Pasture Gate adjustable for Horse Owners	2 - 4 m	110 cm	steel, hot-dip galvanised	1	<b>NEW</b>

available from: March 2026

## Multi-adjustable pasture gate

**New product**

- robust pasture gate for daily use
- made from hot-dip galvanised steel, weatherproof and durable
- multi-adjustable for flexible adaptation to different passageways
- versatile use for cattle, sheep, goats and other animals
- quick and easy attachment to fence posts using the mounting set supplied

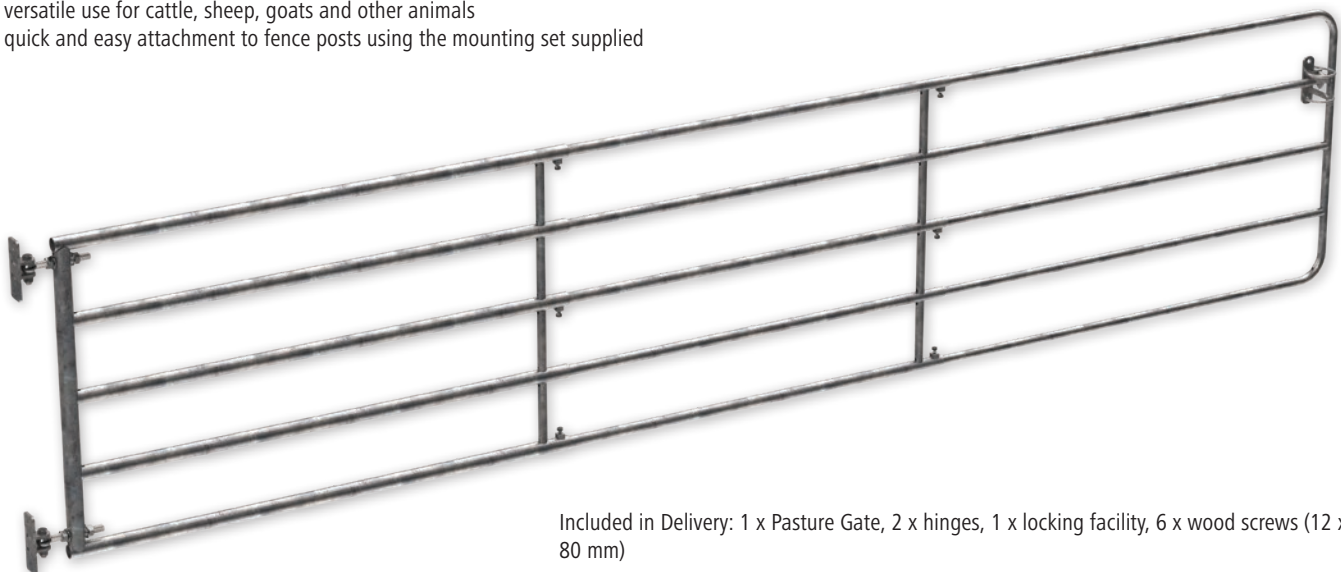

Included in Delivery: 1 x Pasture Gate, 2 x hinges, 1 x locking facility, 6 x wood screws (12 x 80 mm)

Ref. no.	Description	Adjustability	Height	Material		€
442905	Multi-adjustable pasture gate	1.7 - 4 m	90 cm	steel, hot-dip galvanised	1	
442926	Multi-adjustable pasture gate	3.5 - 6 m	110 cm	steel, hot-dip galvanised	1	

available from: March 2026



## Mounting Set for Pasture Gates

- for easy mounting of your pasture gate to the post
- material: hot galvanised metal

Set consisting of: 2 x hinges, 1 x closure option (442558), 6 x wood screws



hot-dip galvanised

Ref. no.		€
44890	1	



## Closing Option for Pasture Gate Mounting Set

- enables you to lock your pasture gate via the brass padlock
- padlock not included
- Material: hot-dip galvanised metal



hot-dip galvanised

Ref. no.		€
442558	1	



## Swing-Through Lock for Fence Gates

- the swing-through lock allows the gate to be opened in both directions
- the lock is fitted to the post and gate using the screws supplied
- can be used on all fence gates
- Material: Metal



Ref. no.	Colour		€
441025	black	1/6	

## Cover for Pasture Gates

- enables the assembly or safe connection of double-leaf gates
- secure locking mechanism with latching function, optionally lockable with padlock (not included)
- suitable for all rigid and extendable pasture gates
- Material: hot-dip galvanised metal

recommended accessories: Locking Spike for Pasture Gates (442572)



Ref. no.		€
442571	1	

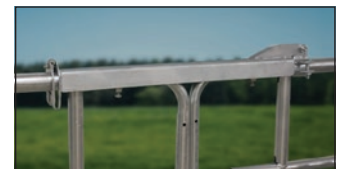

## Two-way lock for pasture gates

- enables the gate to be opened in both directions
- quick and easy installation using the supplied screws and round steel brackets on the post and gate
- can be used for all commercially available pasture gates - without drilling
- secure locking mechanism with latching function, optionally lockable with padlock (not included)
- Material: hot-dip galvanised metal

Ref. no.		€
442942	1/4	

Set consisting of: 1 x two-way lock, 1 x closing plate for gate, 2 x round steel shackle M8 x 26, 2 x round steel shackle M8 x 42, 8 x washers, 8 x self-locking nuts, 2 x wood screw 8 x 50

**New product** 

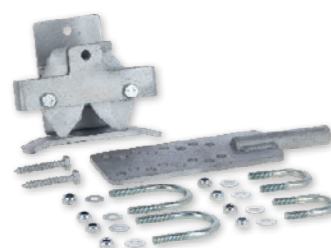

## Stabiliser for adjustable Pasture Gates

- Solid Rubber Wheel Ø 200 mm
- all steel parts are hot dip galvanised
- can be height-adjusted



Ref. no.		€
442559	1	

## Locking Spike for Pasture Gates

- enables open pasture gates to be fixed in any position
- ideal when setting up double-leaf pasture gates to lock the other half of the gate when one leaf is opened - recommended accessory: Cover for Pasture Gate (442571)
- suitable for all rigid and extendable pasture gates
- very simple and quick assembly, all screws and brackets are included
- height can be flexibly adjusted by means of slotted holes, so that pasture gates with larger floor distances can also be fixed in place
- Material: hot-dip galvanised metal



Ref. no.		€
442572	1	





## Electrics Kit for Fence Gates

- kit for additional electrification of your fencing system around fence gates
- fence gate can continue to be opened by hand

441224 Set consisting of: 6 x ring clamp, 6 x ring insulator with short support and metric thread, 1 x rope/tape coupling, 14 m rope Ø 6 mm (Top Line Plus)

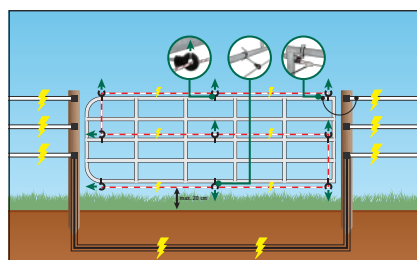
442941 Set consisting of: 9 x ring clamp, 9 x ring insulator with 80 mm metric thread, 1 x rope/tape coupling, 20 m rope Ø 6 mm (Top Line Plus)



Ref. no.	Description	Pieces / unit		€
441224	Set of 6	1 / pack	1/16	
442941	set of 9 especially for wolf defence		1	

## Sheep Hurdle

- practical connecting system for easy and tool-free installation of hoardings
- suitable for the creation of pre-gathering spaces, pens, individual and group boxes or stall dividers
- 7 cross tubes with increasing spacing from bottom to top, tube diameter: 25.0 or 21.3 mm

442603: door with lock latch and reinforced frame, width of 57 cm

442604: door with lock latch and reinforced frame, width of 57 cm

442611 : with two centrally located lamb slips with adjustable slip width (17.5 cm / 24.5 cm)

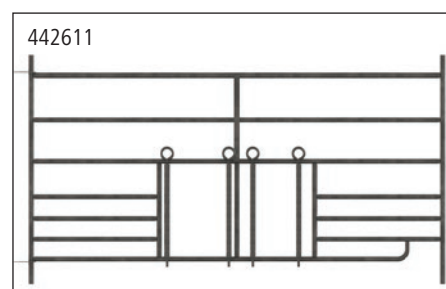
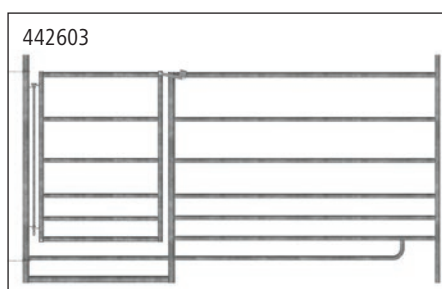
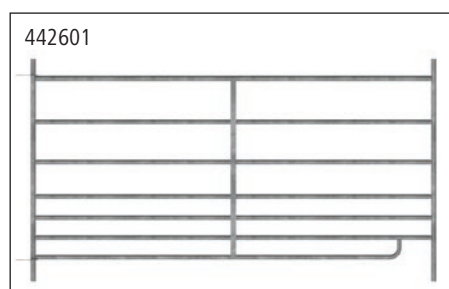

Please note separate freight costs.

Ref. no.	Description	Material	Width	Height			€
442600	Sheep Hurdle	steel, hot-dip galvanised	137 cm	92 cm	1	80	
442601	Sheep Hurdle	steel, hot-dip galvanised	183 cm	92 cm	1	80	
442602	Sheep Hurdle	steel, hot-dip galvanised	275 cm	92 cm	1	80	
442603	Sheep Hurdle with door	steel, hot-dip galvanised	183 cm	92 cm	1	68	
442604	Sheep Hurdle with door	steel, hot-dip galvanised	275 cm	92 cm	1	60	
442611	Sheep Hurdle with 2 lamb slips	steel, hot-dip galvanised	183 cm	92 cm	1	60	

Ref. no.	Description	Material	Length	Width	Height	Ø		€
442606	Spare Strut for connecting hoardings with shafts	steel, hot-dip galvanised			92 cm		1	
442607	Bucket Holder	steel, hot-dip galvanised				30 cm	1	
32702	Double Hay Rack	steel, hot-dip galvanised	61.5 cm	50 cm	48 cm		1	
32704	Double Hay Rack	steel, hot-dip galvanised	62.5 cm	51 cm	48 cm		1	
442612	Connecting Rod for Plug Trays	steel, hot-dip galvanised			95 cm		1/10	
442617	Replacement Hand Clasp for modular hoarding with door (442603)	steel, hot-dip galvanised	12 cm	6 cm	4.5 cm		1/20	
442618	Spare Shaft for modular hoarding with 2 lamb slips	steel, hot-dip galvanised	50 cm				1/20	



## Pasture Shelter Complete Set for Sheep and Goats

- for setting up a mobile shelter or grazing tent for sheep and goats (protection against rain, wind and sun)
- Shelter dimensions: 2.75 m x 2.75 m
- tool-free and easy assembly using plug connections and wing nuts
- extremely durable and UV-stable truck tarpaulin, stitched at the corners
- the tarpaulin is fastened to the roof structure using leather straps or using the supplied cable ties with the portable pens

442614 Set consisting of:



- 1 x roof structure including screws and tarpaulin with eyelets and leather straps (442615)
- 3 x portable pen, 275 x 92 cm, galvanised metal (442602)
- 1 x portable pen with door, 275 x 92 cm, galvanised metal (442604)
- 4 x ground anchor for portable pen shelter, 60 cm, galvanised metal (442616)

(442616)

442615 Set consisting of:

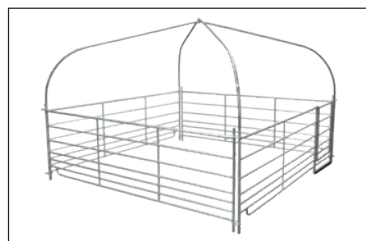
- 1 x roof structure including screws and tarpaulin with eyelets and leather straps (442615)



Ref. no.	Description		€
442614	Portable pen set incl. door and matching canopy with tarpaulin and poles	1 	
442615	Roofing (tarpaulin and poles) without portable pens	1	

Ref. no.	Description	Material	Length	Ø	MOQ	Pieces / unit		€
442616	Ground Anchor for Portable Pen Shelter	galvanised metal	60 cm	10 mm	1 pack	4 / pack	1/10	









## Pasture Panel

- perfect for erecting mobile and flexible fencing as well as temporary horse boxes
- also commonly used to fence off riding and training areas
- also suitable for constructing trap systems and gangways
- height of upper tube 1.6 m
- safety mounting bracket prevents animals from being injured. When landing on the panel, the animal does not fall between two panels if it slips
- made from flat oval pipe 50 x 30 mm
- clear distance between tubes 20 cm
- rapid chain fastening makes it quicker and easier to connect several panels
- very stable at light loads
- curved feet ensure excellent stability



Liability for any injuries to the horses is excluded, as horses can exhibit unpredictable behaviour.

Ref. no.	Description	Material	Length	Height			€	
442591	Pasture Panel without gate	steel, hot-dip galvanised	240 cm	170 cm	1	35		
442592	Pasture Panel without gate	steel, hot-dip galvanised	300 cm	170 cm	1	36		
442593	Pasture Panel without gate	steel, hot-dip galvanised	360 cm	170 cm	1	18		

Please note separate freight costs.

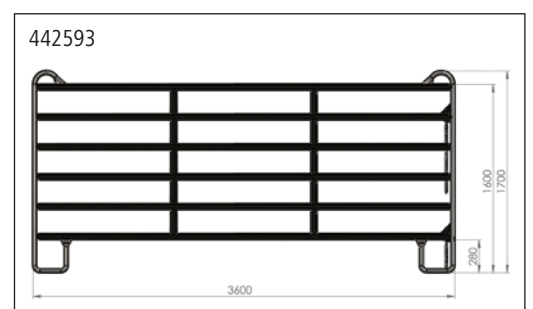
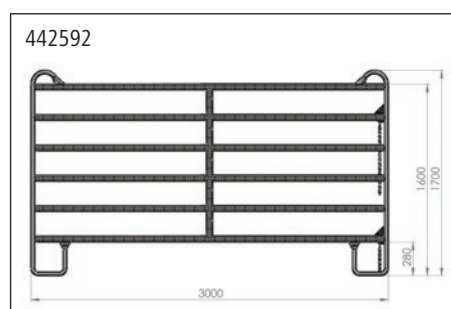
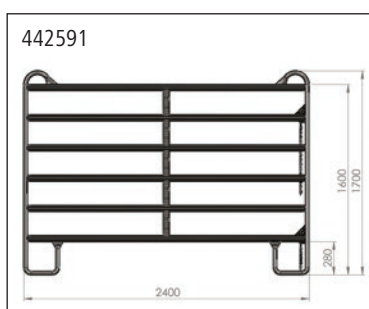



Rapid chain fastening, hot-dip galvanised



Safety Mounting Bracket



curved feet ensure excellent stability



## Fence Panel with Gate

- allows an opening to be created in the fencing
- gate width 1 m
- lock for opening and closing the fenced area

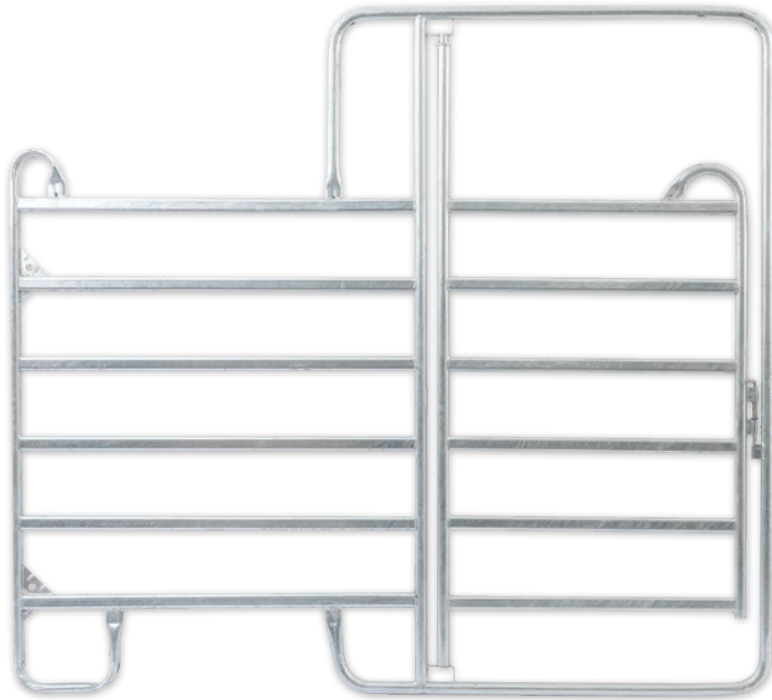







Example for mounting



Locking Bolt

Please note separate freight costs.

Ref. no.	Description	Material	Length	Height			€	
442594	Fence Panel with Gate	steel, hot-dip galvanised	240 cm	220 cm	1	18		
442595	Fence Panel with Gate	steel, hot-dip galvanised	300 cm	220 cm	1	18		
442596	Fence Panel with Gate	steel, hot-dip galvanised	360 cm	220 cm	1	18		

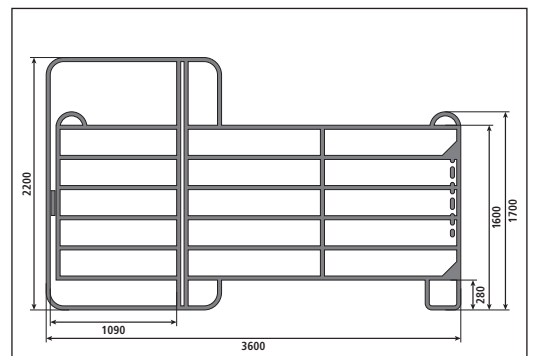
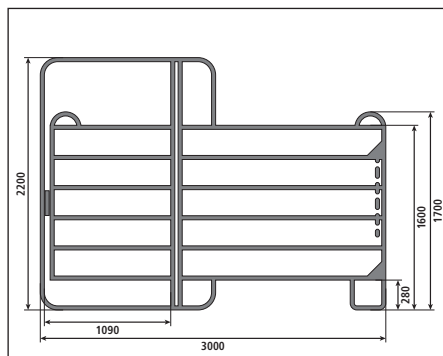
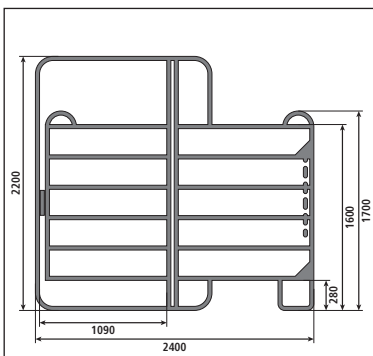

## Longitudinal connector for pasture panels

- secures pasture panels reliably and stably in the longitudinal direction
- corrosion-resistant and weatherproof for long-term outdoor use
- suitable for standard pasture panels with 50 x 30 mm profiles
- including screws and nuts for quick and secure fastening
- Material: hot-dip galvanised metal

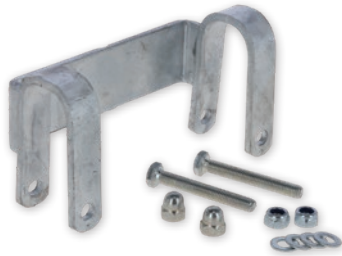

**New product** NEW



Ref. no.		€
442622	1/10	

Included in Delivery: 1 x longitudinal connector, 2 x screws, 4 x washers, 2 x self-locking nuts, 2 x cap nut

## Corner connector for pasture panels

- connects two pasture panels securely at a 90° angle for stable fence corners
- corrosion-resistant and weatherproof for long-term outdoor use
- suitable for standard pasture panels with 50 x 30 mm profiles
- including screws and nuts for quick and secure fastening
- Material: hot-dip galvanised metal



**New product** NEW



Ref. no.		€
442623	1/10	

Included in Delivery: 1 x corner connector, 2 x screws, 4 x washers, 2 x self-locking nuts, 2 x cap nut

## Gate connector for pasture panels

- Gate connector for secure and stable connection of pasture panel gates
- corrosion-resistant and weatherproof for long-term outdoor use
- suitable for standard pasture panels with 50 x 30 mm profiles
- including screws and nuts for quick and secure fastening
- Material: hot-dip galvanised metal



**New product** NEW

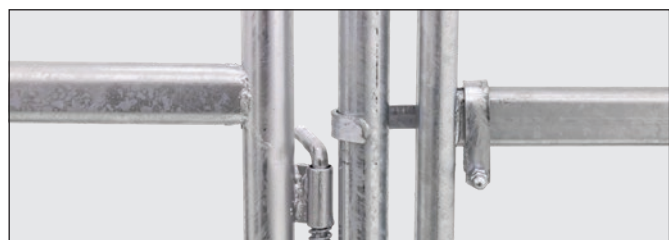

Ref. no.		€
442629	1/10	

Included in Delivery: 1 x gate connector, 1 x screw, 2 x washers, 1 x self-locking nut, 1 x cap nut

## T-connector for pasture panels

- robust T-connector for secure connection of three T-shaped pasture panels
- corrosion-resistant and weatherproof for long-term outdoor use
- suitable for standard pasture panels with 50 x 30 mm profiles
- including screws and nuts for quick and secure fastening
- Material: hot-dip galvanised metal



**New product** NEW

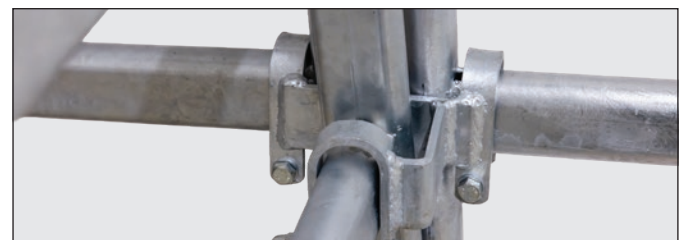

Ref. no.		€
442627	1/10	

Included in Delivery: 1 x T-connector, 3 x screws, 6 x washers, 3 x self-locking nuts, 3 x cap nut

## Wall/floor Bracket for Pasture Panels

- for fixing pasture panels or modular hoardings to the wall or ground
- by omitting the screw close to the wall, panels can also be fixed at a slight angle to compensate for small slopes or inclines in the terrain
- Material: hot-dip galvanised metal



Ref. no.		€
442573	1/10	

## Connector for Pasture Panels

- ideal for connecting two pasture panels (flat oval tubes)
- we always recommend the use of two connectors for a secure connection of two pasture panels
- also enables the connection of pasture panels across corners
- suitable for all pasture panels with/without gate
- Material: hot-dip galvanised metal



Ref. no.		€
442574	1/20	

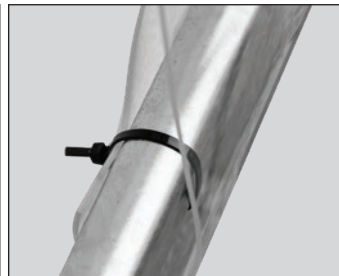

## Panel Cover Penetration Protection

- innovative and robust solution as step protection for pasture gates and panels: eliminates the risk of horses getting their heads or legs caught between the steel tubes and getting stuck
- protection against wind and draughts for horse and bedding or feed without darkening the area behind it
- ideal for mobile stables, paddocks and partitions, exclusively for outdoor use in agriculture or industry
- compatible with all commercially available pasture gates and panels
- suitable for various sizes and breeds of horse
- by combining several panel covers, any size of pasture gate or panel can be covered, size customisable
- easy and problem-free to install thanks to low product weight and delivery including necessary mounting parts and pre-drilled holes
- Material: PVC, UV-stabilised

can be used for panels and pasture gates



Included in Delivery: 1 x PVC tarpaulin 1.5 m x 1 m x 2.5 mm, 7 x cable tie, 7 x screws, 14 x washer, 7 x cap nut, 1 x setup instructions

Ref. no.	Colour	Length	Width	Material Thickness			€
442628	transparent	1.5 m	1 m	2.5 mm	1	48	



Three point attachment (with safety guard)



Circumferential roof edge protection



2 square tubular supports for even more stability

When used with feeds that may attack the galvanised surface (e.g. silage), apply a protective coat of paint first.

## Four-sided Manger for Palisade Feeding Grid

- universal hay rack for horses and cattle
- suitable for round and rectangular bales up to 1.8 m in length or diameter
- extremely stable design, high material thickness, 2 square pipe beams
- 2 sides can easily be opened for filling
- height-adjustable runners (adjustable to the animal's size)
- Three-point Attachment
- very little food loss
- supplied as a construction kit including circumferential roof edge protection, three-point safety clip
- Internal trough dimensions: approx. 2.0 x 2.0 m
- Material: hot-dip galvanised metal



Please note separate freight costs.

Ref. no.	Length	Width	Height	Feed Areas			€	
291255	212 cm	212 cm	250 cm	12	1	6		

## Square Hay Rack for Horses with Safety Feeding Barrier

- Feed Rack for Horses with 12 feeding places
- suitable for round and rectangular bales up to 1.8 m in length or diameter
- extremely stable design, high material thickness, 2 square pipe beams
- 2 sides can easily be opened for filling
- height-adjustable runners (adjustable to the animal's size)
- Three-point Attachment
- very little food loss
- supplied as a construction kit including circumferential roof edge protection, three-point safety clip
- Internal trough dimensions: approx. 2.0 x 2.0 m
- Material: hot-dip galvanised metal



Please note separate freight costs.

Ref. no.	Length	Width	Height	Feed Areas			€	
291256	212 cm	212 cm	250 cm	12	1	6		

## Slow Feeding Net

The net is placed over the food/bales so that the animals eat more slowly and thoroughly, helping to improve their digestion.

- reduced dust formation • appropriate feeding • little food is wasted • with rubber cord • Material: Polypropylene

art. 291344 galvanised frame

- for easier fastening of the slow feeding net • convenient and quick to fold up and down • suitable for parcel shipping

Ref. no.	Colour	Length	Width	Mesh Size		€
291260	green	3.6 m	2.4 m	45 x 45 mm	1/3	
291261	green	3.6 m	2.4 m	100 x 100 mm	1/10	
291262	green	2.8 m	2.8 m	45 x 45 mm	1/3	
291263	green	2.8 m	2.8 m	100 x 100 mm	1/6	



Ref. no.	Description	Material	Length	Width	suitable for		€
291344	Frame for Slow Feeding Net	galvanised metal	181 cm	181 cm	291255, 291256, 291289	1	

## Standard four-sided Rack with Palisade Feeding Grid

- suitable for round and rectangular bales up to 1.8 m in length or diameter
- ground tub reinforced with 2 additional pipes
- 2 sides can easily be opened for filling
- newly developed three-point linkage with foldable mountings for the tractor drawbar
- very little food loss
- Internal trough dimensions: approx. 1.9 x 1.9 m
- supplied as a construction kit including circumferential roof edge protection
- height-adjustable runners (adjustable to the animals' size)
- Material: hot-dip galvanised metal



Ref. no.	Length	Width	Height	Feed Areas			€	
291289	230 cm	230 cm	250 cm	12	1	6		



Please note separate freight costs.



## Square Hay Rack Hobby

- suitable for round and rectangular bales up to 1.4 m in length or diameter
- ground tub reinforced with 2 additional pipes
- 2 sides can easily be opened for filling
- newly developed three-point linkage with foldable mountings for the tractor drawbar
- very little food loss
- Internal trough dimensions: approx. 1.45 x 1.45 m
- height-adjustable runners (adjustable to the animal's size)
- supplied as a construction kit including circumferential roof edge protection
- Material: hot-dip galvanised metal



Ref. no.	Length	Width	Height	Feed Areas			€	
291300	150 cm	150 cm	240 cm	8	1	6		

Please note separate freight costs.



## Square runner with safety feeding grille Hobby

- suitable for round and rectangular bales up to 1.4 m in length or diameter
- with safety feed fence ideal for horses and ponies
- Base tray additionally reinforced
- can be opened from one side for filling
- newly developed three-point linkage with foldable mountings for the tractor drawbar
- very little food loss
- Internal trough dimensions: approx. 1.45 x 1.45 m
- height-adjustable runners (adjustable to the animal's size)
- supplied as a construction kit including circumferential roof edge protection
- Material: galvanised metal

When used with feeds that may attack the galvanised surface (e.g. silage), apply a protective coat of paint first.

Ref. no.			€	
291348	1	6		

Please note separate freight costs.

**New product** 



## Round Rack with 8 Feeding Slots

for loose feed or small high-pressure bales

- palisade feeding grid
- supplied as a kit
- 4-part, can be transported in an estate car
- outdoors or in play pens, the segments can also be used to set up wall or corner mangers
- no three-point hitch
- Material: hot-dip galvanised metal

Technical Data	291257
Height	116 cm
Exterior Diameter	150 cm
Interior diameter	132.5 cm
Feed Areas	8

Ref. no.			€	
291257	1	5		

Please note separate freight costs.



## Round Rack with 12 Feeding Slots

for normal and round bales

- palisade feeding grid
- 3-piece
- Three-point Attachment
- supplied as a kit
- Material: hot-dip galvanised metal

Please note separate freight costs.

Technical Data	291258
Height	116 cm
Exterior Diameter	236 cm
Interior diameter	219 cm
Feed Areas	12



Ref. no.			€	
291258	1	5		



## Fodder Rack

- for sheep, goats, deer or calves
- for small bales and loose hay
- with concentrated feed trough
- supplied disassembled
- Material: hot-dip galvanised metal





Ref. no.	Description	Length	Width	Height	Rod distance			€
291347	with roof	115 cm	81 cm	131.5 cm	78 mm	1	10	
291345	without roof	112.5 cm	68.5 cm	116 cm	78 mm	1	10	

Ref. no.	Description	Material	Length	Width	Height	suitable for		€
291346	Roof for Feed Rack	hot-dip galvanised metal	115 cm	79.5 cm	22 cm	291345	1	

## Hay Net for Round Bales

- feeding net for hay and silage bales for feed-saving roughage supply to horses • hay is no longer dispersed • secure attachment by elastic cord • tear-resistant and durable • soft material, protects the horse's mouth • universal use • Rope thickness: 6 mm • not recommended for horses with horseshoes due to risk of fouling • Material: Polypropylene



Ref. no.	Colour	Height	Ø	Mesh Size	 	€
3227439	green	140 cm	140 cm	4,5 x 4,5 cm	1/2 48	
321603	green	150 cm	150 cm	4,5 x 4,5 cm	1/2 32	
3227440	green	160 cm	160 cm	4,5 x 4,5 cm	1/2 40	
321604	green	180 cm	180 cm	4,5 x 4,5 cm	1/2 30	

## Hay Net for Round Bales

- hay is no longer dispersed • fastening with integrated cable
- tear-resistant and durable • soft material, protects the horse's mouth
- universal use • Rope thickness: 6 mm • Material: Polypropylene



Do not hang up - only for pre-tensioning from above!

Ref. no.	Colour	Height	Ø	Mesh Size		€
321605	green	160 cm	125 cm	4,5 x 4,5 cm	1/2	
321606	green	180 cm	150 cm	4,5 x 4,5 cm	1/2	

## Hay Bell for Round Bales





- for round bales with max. ø 160 x H 125 cm or ø 130 x H 135 cm
- shatter-proof, frost-proof plastic material with built-in UV protection
- sturdy construction
- with animal-friendly and non-damaging food openings
- water-removing rain channels over the food openings
- with integrated carrying handle, suitable for front loader forks
- with integrated fixing eyelets for fixing the base to the hay bell
- base (available separately) for dry storage of the bales – can be locked for transportation with the hay bell



14559



Technical Data	14557	14558
Height	164 cm	164 cm
Exterior Diameter	185 cm	185 cm
Interior diameter	160 cm	160 cm
Feed Areas	5	10

Please note separate freight costs.

Ref. no.	Colour	suitable for			€
14557	olive green	Cattle / Horses	1	6	
14558	olive green	Sheep / Goats / Calves / Ponies	1	6	

Ref. no.	Description	Colour	Material	suitable for		€
14559	Base for Hay Bell	olive green	plastic, UV-stabilised	14557, 14558	1	
14556	Floor Anchor for Hay Bell and Base		Metal	14557, 14558, 14559	1/10	

# Netting

Made in the EU



Fence netting is always the first choice when you want to cordon off an area quickly and easily to hold animals, or even to protect your property from wild animals. Sheep and goats place especially high demands on fence netting: Sheep are robust animals and also protected by their dense wool against electrical shocks. This is why care should be taken to select a powerful fence device (12 V or 230 V) for all netting, in order to achieve the maximum tending safety. Our fence nettings are available in different versions and thus suitable for all types of ground conditions and applications. The combination of robust plastic or fibreglass posts and high-quality conductor materials ensure the highest herding safety, both for professional sheep farmers as well as small animal husbandry in the hobby segment.

Stainless steel connection clip for the rapid connection of several nets!



extremely stable welded knots



Colour-contrasting head insulator on the starting post makes net set-up easy



Vertical: stiff plastic braces = improved footing



## Pasture net summary of sheep / goat and wolf nets

Ref. no.	Model	Page	horizontal colour	vertical colour	Length	Height	Premium	Single Prong	Double Prong	with vertical struts	can be electrified	with separately connectable ground wire	Plus/minus-capable net	sheep	goat	wolf	dog
27840	TitanNet Premium XBraid	222	Blue	Blue	50 m	122 cm	•	•	•	•	•	•	•	•	•	•	•
27841	TitanNet Premium XBraid	222	Blue	Blue	50 m	122 cm	•	•	•	•	•	•	•	•	•	•	•
27811	TitanNet Premium	213	Orange	Blue	50 m	90 cm	•	•	•	•	•	•	•	•	•	•	•
27813	TitanNet Premium	213	Orange	Blue	50 m	108 cm	•	•	•	•	•	•	•	•	•	•	•
27821	TitanNet Premium Plus	223	White	Blue	50 m	90 cm	•	•	•	•	•	•	•	•	•	•	•
27823	TitanNet Premium Plus	223	White	Blue	50 m	108 cm	•	•	•	•	•	•	•	•	•	•	•
27830	TitanNet Premium Vario	224	Blue	White	50 m	108 cm	•	•	•	•	•	•	•	•	•	•	•
27831	TitanNet Premium Vario	224	Blue	White	50 m	108 cm	•	•	•	•	•	•	•	•	•	•	•
27832	TitanNet Premium Vario	224	Blue	White	50 m	122 cm	•	•	•	•	•	•	•	•	•	•	•
27833	TitanNet Premium Vario	224	Blue	White	50 m	122 cm	•	•	•	•	•	•	•	•	•	•	•
27865	Titan LIGHT Premium	226	Blue	White	50 m	90 cm	•	•	•	•	•	•	•	•	•	•	•
27864	Titan LIGHT Premium	226	Blue	White	50 m	90 cm	•	•	•	•	•	•	•	•	•	•	•
27867	Titan LIGHT Premium	226	Blue	White	50 m	108 cm	•	•	•	•	•	•	•	•	•	•	•
27866	Titan LIGHT Premium	226	Blue	White	50 m	108 cm	•	•	•	•	•	•	•	•	•	•	•
27325	Titan Net	214	White	Green	50 m	90 cm	•	•	•	•	•	•	•	•	•	•	•
27326	Titan Net	214	White	Green	50 m	90 cm	•	•	•	•	•	•	•	•	•	•	•
27327	Titan Net	214	White	Green	50 m	108 cm	•	•	•	•	•	•	•	•	•	•	•
27328	Titan Net	214	White	Green	50 m	108 cm	•	•	•	•	•	•	•	•	•	•	•
27351	TitanLight Net	215	Orange	Black	50 m	90 cm	•	•	•	•	•	•	•	•	•	•	•
27352	TitanLight Net	215	Orange	Black	50 m	90 cm	•	•	•	•	•	•	•	•	•	•	•
27353	TitanLight Net	215	Orange	Black	50 m	108 cm	•	•	•	•	•	•	•	•	•	•	•
27354	TitanLight Net	215	Orange	Black	50 m	108 cm	•	•	•	•	•	•	•	•	•	•	•
27200	EasyNet	216	Yellow	Black	50 m	105 cm	•	•	•	•	•	•	•	•	•	•	•
27910	TitanNet 145	227	White	Blue	25 m	145 cm	•	•	•	•	•	•	•	•	•	•	•
27380	TitanNet 145	227	White	Blue	50 m	145 cm	•	•	•	•	•	•	•	•	•	•	•
27852	OviNet Premium	217	Orange	Orange	50 m	90 cm	•	•	•	•	•	•	•	•	•	•	•
27854	OviNet Premium	217	Orange	Orange	50 m	108 cm	•	•	•	•	•	•	•	•	•	•	•
27251	OviNet	218	Orange	Orange	50 m	90 cm	•	•	•	•	•	•	•	•	•	•	•
27252	OviNet	218	Orange	Orange	50 m	90 cm	•	•	•	•	•	•	•	•	•	•	•
27253	OviNet	218	Orange	Orange	50 m	108 cm	•	•	•	•	•	•	•	•	•	•	•
27254	OviNet	218	Orange	Orange	50 m	108 cm	•	•	•	•	•	•	•	•	•	•	•
27266	OviNet	218	Green	Green	50 m	90 cm	•	•	•	•	•	•	•	•	•	•	•
27268	OviNet	218	Green	Green	50 m	108 cm	•	•	•	•	•	•	•	•	•	•	•
27388	OviNet Maxi	228	Blue	White	50 m	122 cm	•	•	•	•	•	•	•	•	•	•	•
27394	OviNet Maxi	228	Blue	White	50 m	122 cm	•	•	•	•	•	•	•	•	•	•	•
27986	OviNet 170	229	Blue	White	25 m	170 cm	•	•	•	•	•	•	•	•	•	•	•
27215	WildNet	230	Blue	Blue	50 m	73 cm	•	•	•	•	•	•	•	•	•	•	•
27900	ClassicNet	219	Orange	Orange	50 m	90 cm	•	•	•	•	•	•	•	•	•	•	•
27901	ClassicNet	219	Orange	Orange	50 m	90 cm	•	•	•	•	•	•	•	•	•	•	•
27902	ClassicNet	219	Orange	Orange	50 m	108 cm	•	•	•	•	•	•	•	•	•	•	•
27903	ClassicNet	219	Orange	Orange	50 m	108 cm	•	•	•	•	•	•	•	•	•	•	•

Length

Height

with PREMIUM Post

Single Prong

Double Prong

with vertical struts

can be electrified

with separately connectable ground wire

Plus/minus-capable net

\* see detailed image above

\*\* for additional earthing along whole net length

# Discover the new generation of posts for pasture nets



The new PREMIUM posts are the latest innovation from AKO. Special attention was paid to the selection of the right materials during the development of these new posts. The combination of a high-strength thermoplastic and long fibreglass fibres provides excellent stability and rigidity. The glass-fibre reinforced material guarantees maximum UV resistance and durability.

Compared to conventional posts, the new PREMIUM posts are significantly stiffer and less susceptible to bending under tensile load (especially at the beginning or end of the net and in the corners). Thus, a reliable and upright stand of the net - even in adverse weather conditions - can be guaranteed.

Special attention was paid to the everyday handling of the nets. Despite retaining the tried-and-tested diameter, it was possible to achieve slight reductions in the weight of the new post, thus enabling even more comfortable working.

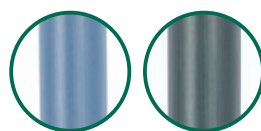
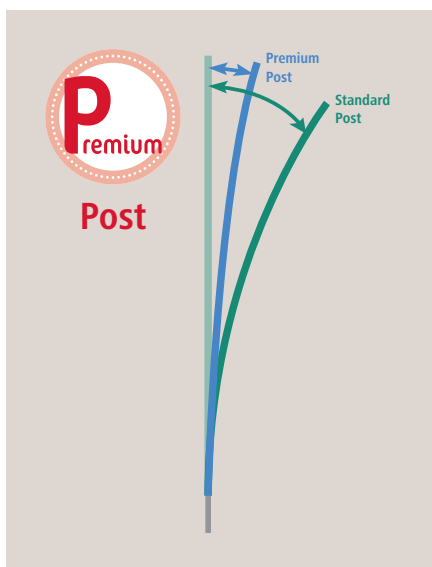

The posts in the following two colour variants are used in the AKO Premium nets:

- blue for sheep/wolf nets for better visibility for humans and animals
- anthracite for poultry nets for discreet colouring in gardens



When designing the new head insulator, we incorporated the years of experience of professionals in the field. This, just like the ground nail, is sprayed inseparably with the post in the production process and guarantees a permanent hold. The new, rounded design of the head insulator prevents the wires from snagging when the nets are rolled up and out.



The galvanised ground nails the post have also been extended and provide even more secure anchorage in the soil - even in damp and soft ground.

Compared to conventional net posts, the nails (single and double prong) are firmly overmoulded at the end of the post and are thus securely and inseparably connected to the post.



## Curious to find out more?

Then see for yourself - all of our PREMIUM nets are already equipped with the new posts to meet the highest demands of professional animal husbandry.

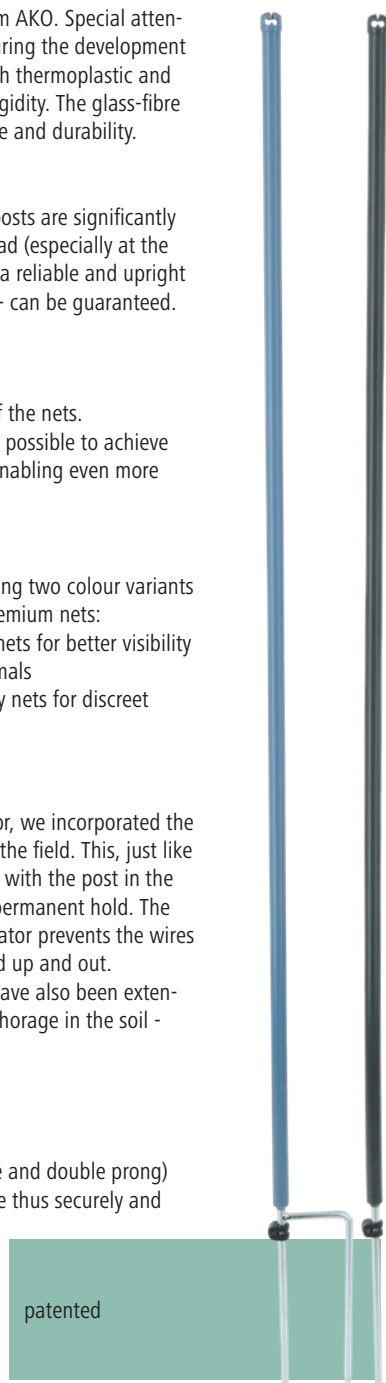

Spare parts for pasture nets can be found at the end of the catalogue!

# AKO as a partner to professional sheep farmers

## ... with the ideal products

As a professional in your field, you need products that:

- Make your everyday life easier
- Are durable and robust
- offer added value
- Are easy and quick to assemble
- Are reliable and conductive!

We offer you the right solutions to support your day-to-day work!



**Premium**

**THE lightest: OviNet Premium**

- 10 % lighter than comparable conventional nets
- especially friendly for small game

Item 27852 (90 cm)  
27854 (108 cm)

**Premium**

**THE most flexible: TitanNet Premium Plus**

- Flexible connectivity
- connectable ground wire prevents wild animal damage

Item 27821 (90 cm)  
27823 (108 cm)

**Premium**

**THE most robust: TitanNet Premium Xbraid**

- wear-protected and long-lasting
- excellent conductivity

Item 27841 (122 cm)  
27840 (122 cm)

## ... with the right quality that's Made in Europe!

Discover many other solutions for sheep farming, from Aesculap clippers to breeding accessories in the Kerbl catalogue...

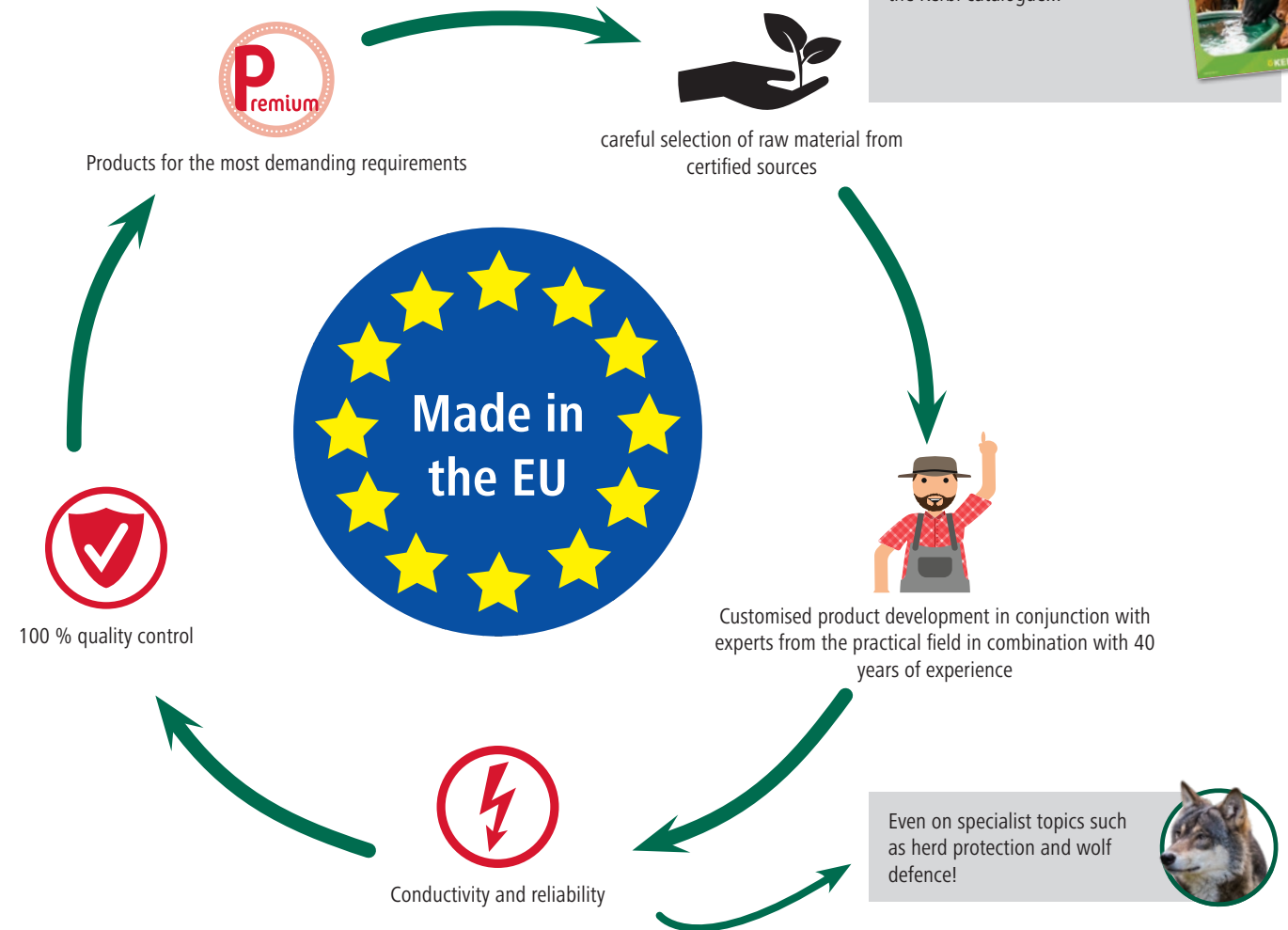

## AKO TitanNet Premium



Easy and fast repairs with our new Litzclip connectors.

### AKO TitanNet Premium

Our „classic“ from the TitanNet series in a new design and with the new patented PREMIUM posts.

- height 90 cm (9 horizontal wires) or 108 cm (10 horizontal wires) available
- extremely durable PREMIUM posts for maximum stability and weather resistance with galvanised double prong
- rigid vertical struts in every mesh of the net provide improved stability and maintain the height of the net, even when the ground is very unlevel
- equipped with a particularly conductive combination of copper and stainless steel wires, this mesh boasts super-low resistance (0.27 or 0.25 Ohm/m) and therefore keep the animals being protected inside the fence, but also attackers from outside away
- reinforced, current-carrying top wire as a lifeline for the entire net - increased conductivity throughout the entire course of the net
- PREMIUM posts are significantly stiffer than conventional net posts, and therefore less susceptible to tensile load
- proven vertical struts ensure that the required net height is achieved even on difficult terrain
- small separation of horizontal wires in the lower part of the net retains even small animals within the net

3-year UV stability warranty



Made in the EU

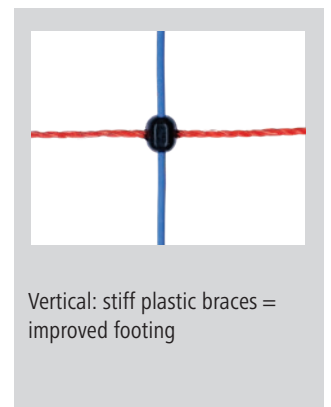
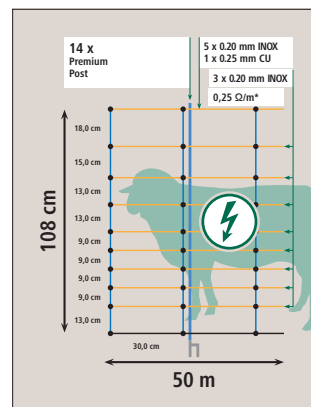
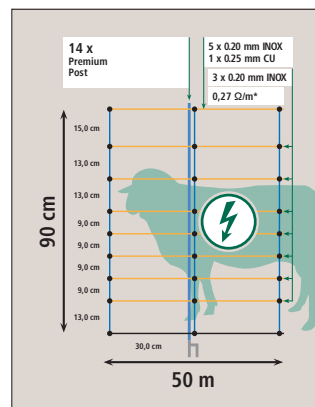
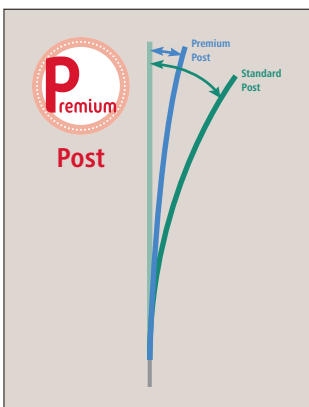

Vertical: stiff plastic braces = improved footing

\* Based on the total conductor cross-section of all live poly wires in the pasture netting

Ref. no.	Ground Spike	Length	Height	Colour	Qty Posts	matching replacement post			€
27811	Double Prong	50 m	90 cm	blue / orange	14	27805	1	24	
27813	Double Prong	50 m	108 cm	blue / orange	14	27807	1	24	

## AKO TitanNet



### AKO TitanNet

- height 90 cm (7 horizontal wires) or 108 cm (8 horizontal wires)
- robust plastic posts with galvanised single or double prong
- rigid vertical struts in every mesh of the net provide improved stability and maintain the height of the net, even when the ground is very unlevel
- reinforced, current-carrying top wire as a lifeline for the entire net - increased conductivity throughout the entire course of the net
- equipped with the particularly conductive combination of copper and stainless steel conductors, this mesh boasts super-low resistance (0.27 or 0.25 Ohm/m) and therefore keeps the protected animals inside the fence, and external attackers away

Easy and fast repairs with our new Litzclip connectors.

3-year UV stability warranty

Made in the EU

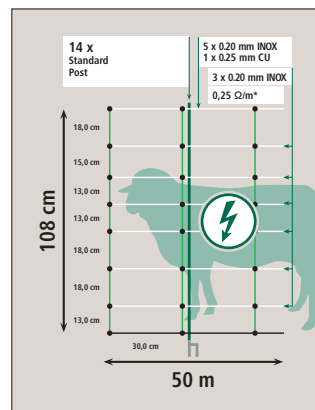
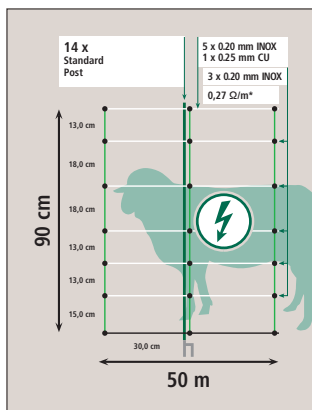

Vertical: stiff plastic braces = improved footing

- high quality at a good price
- suitable for hilly terrain
- reduced number of horizontal wires provides weight advantage and allows small game to pass through more easily

\* Based on the total conductor cross-section of all live poly wires in the pasture netting

Ref. no.	Ground Spike	Length	Height	Colour	Qty Posts	matching replacement post		€
27325	Single Prong	50 m	90 cm	white / green	14	27346	1 24	
27326	Double Prong	50 m	90 cm	white / green	14	27347	1 24	
27327	Single Prong	50 m	108 cm	white / green	14	27348	1 24	
27328	Double Prong	50 m	108 cm	white / green	14	27349	1 24	

## TitanLight Net



### TitanLight Net

Our „lightweight“ in the TitanNet range!

- height 90 cm (5 horizontal wires) or 108 cm (6 horizontal wires)
- robust plastic posts with galvanised bottom tip
- rigid vertical struts in every mesh of the net provide improved stability and maintain the height of the net, even when the ground is very unlevel
- equipped with a particularly conductive combination of copper and stainless steel wires, this mesh boasts super-low resistance (0.27 or 0.25 Ohm/m) and therefore keep the animals being protected inside the fence, but also attackers from outside away
- reinforced, current-carrying top wire as a lifeline for the entire net - increased conductivity throughout the entire course of the net



Easy and fast repairs with our new Litzclip connectors.

3-year UV stability warranty



Made in the EU

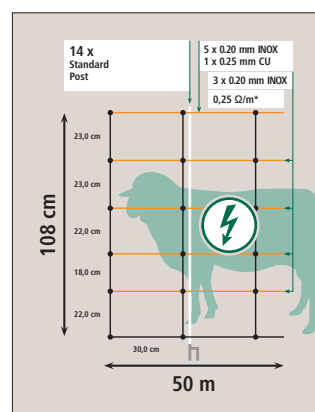
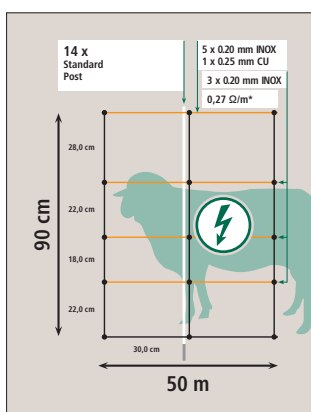

\* Based on the total conductor cross-section of all live poly wires in the pasture netting

Vertical: stiff plastic braces = improved footing

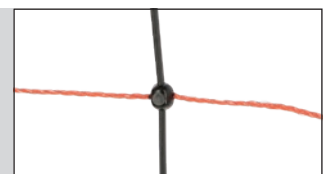

- increased mesh spacings - less power leakage in heavy vegetation
- easy handling due to light weight
- ground game and hedgehogs can "slip through" without risk

Ref. no.	Ground Spike	Length	Height	Colour	Qty Posts	matching replacement post			€
27351	Single Prong	50 m	90 cm	orange / black	14	27202	1	30	
27352	Double Prong	50 m	90 cm	orange / black	14	27203	1	30	
27353	Single Prong	50 m	108 cm	orange / black	14	27229	1	30	
27354	Double Prong	50 m	108 cm	orange / black	14	27230	1	30	

## AKO Easy Net



Easy and fast repairs with our new Litzclip connectors.

### AKO EasyNet

Sheep netting with ground separation - perfect conductivity even with heavy vegetation.

- 15 especially light and robust fibreglass posts with galvanised single prong
- extremely good conductivity thanks to the combination of stainless steel conductors with tinned copper conductors in each horizontal strand
- rigid vertical struts every 90 cm in the net provide improved stability and maintain the height of the net, even when the ground is unlevel
- unusually large ground clearance and mesh size reduce electrical losses through current dissipation

3-year UV stability warranty



Made in the EU



- especially fast attachment and removal due to large mesh sizes
- extremely stable and resistant fibreglass posts
- easy handling due to light weight
- 19 cm ground clearance of the first current-carrying wire simplifies mowing and reduces current dissipation through the vegetation

with reinforced black vertical bars, spacing 90 cm

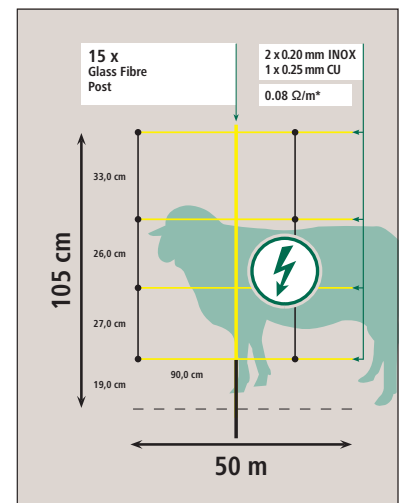

\* Based on the total conductor cross-section of all live poly wires in the pasture netting

Ref. no.	Ground Spike	Length	Height	Colour	Qty Posts	matching replacement post	€
27200	Single Prong	50 m	105 cm	yellow / black	15	27201 1 40	
Ref. no.	Description	Ground Spike	Colour	Material	Post height	€	
27201	Spare Post	Single Prong	yellow	Fibreglass	105 cm	1/50	
44428	Spare Insulator for Oval Steel Post		black	Plastic		1/25/1000	

## AKO OviNet Premium



The net for professional sheep farmers: especially lightweight, since 10 % lighter than conventional comparable nets!

### AKO OviNet Premium

- height 90 cm (7 horizontal wires) or 108 cm (8 horizontal wires)
- the proven mesh width of 30 cm from the Titan nets is now also available as an Ovi net with robust and resistant plastic strands: this combination significantly reduces the overall weight of the net and makes it a comfortable lightweight helper for professional users' daily work
- extremely durable PREMIUM posts for maximum stability and weather resistance with galvanised double prong
- equipped with a particularly conductive combination of copper and stainless steel wires, this mesh boasts super-low resistance (0.27 or 0.25 Ohm/m) and therefore keep the animals being protected inside the fence, but also attackers from outside away
- reinforced, current-carrying top wire as a lifeline for the entire net - increased conductivity throughout the entire course of the net

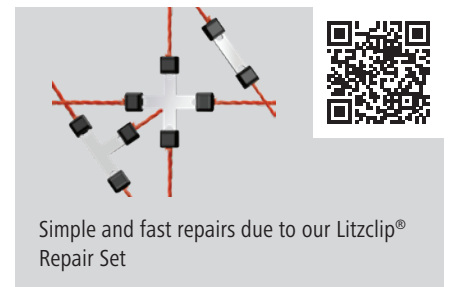

10 % lighter than comparable conventional nets



3-year UV stability warranty



Made in the EU

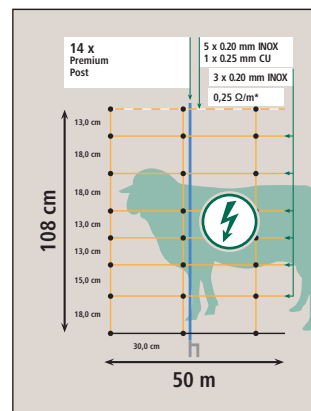
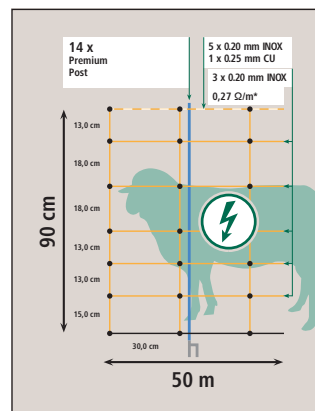
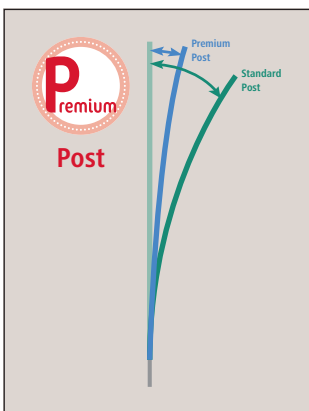

\* Based on the total conductor cross-section of all live poly wires in the pasture netting

Ref. no.	Ground Spike	Length	Height	Colour	Qty Posts	matching replacement post	€
27852	Double Prong	50 m	90 cm	orange	14	27805 1 30	
27854	Double Prong	50 m	108 cm	orange	14	27807 1 30	

## AKO OviNet



**Top Seller**

### AKO OviNet

- robust construction combined with easy handling for professional and amateur sheep farmers
- stable posts with galvanised ground spikes
- Combination of copper and stainless steel conductors ensures low resistance - ideal for effective animal husbandry and protection against intruders
- especially in the lower net area, the smaller meshes provide reliable restraint, even for young animals
- the reinforced current-carrying upper wire with copper conductors optimises current distribution throughout the entire net - for sustainable and reliable protection

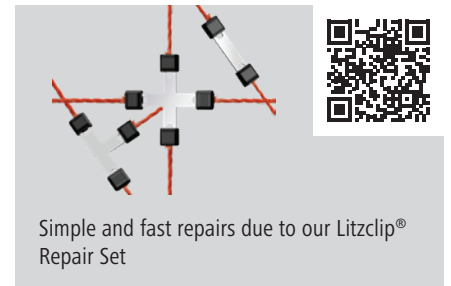

Simple and fast repairs due to our Litzclip® Repair Set

Especially well suited for use with several nets in a row.  
Optimum current supply to the most remote sheep net, thanks to galvanised copper conductor in the top strand of wire. 20 times higher conductivity than standard nets!

3-year UV stability warranty



Made in the EU

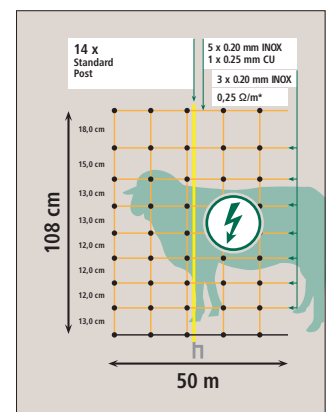
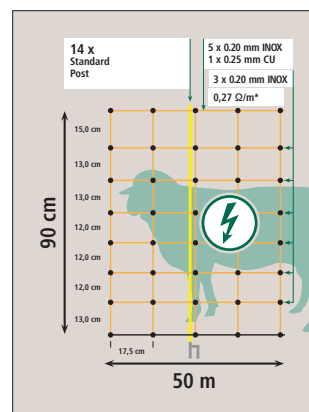

\* Based on the total conductor cross-section of all live poly wires in the pasture netting

Ref. no.	Ground Spike	Length	Height	Colour	Qty Posts	matching replacement post		€
27251	Single Prong	50 m	90 cm	orange	14	27301	1 30	
27252	Double Prong	50 m	90 cm	orange	14	27303	1 30	
27253	Single Prong	50 m	108 cm	orange	14	27305	1 30	
27254	Double Prong	50 m	108 cm	orange	14	27304	1 30	
27266	Double Prong	50 m	90 cm	green	14	27277	1 30	
27268	Double Prong	50 m	108 cm	green	14	27279	1 30	

## ClassicNet



### ClassicNet

- the lightweight fence net is ideal for mobile use and can be easily moved to different pasture areas thanks to its low weight
- flexible to use in two heights, it adapts perfectly to the needs of sheep, goats and other pasture animals
- quick and uncomplicated assembly is effortless thanks to robust plastic posts with galvanised ground spikes - perfect for changing locations
- the highly visible, high-contrast colouring ensures a secure boundary and helps to reliably keep animals inside the fence
- the robust mesh made from welded plastic strands combines stability with flexibility to withstand changing conditions

3-year UV stability warranty



Made in the EU



- high quality at a good price
- improved nodes for higher breaking strength
- reinforced live upper wire with copper conductor - therefore especially conductive

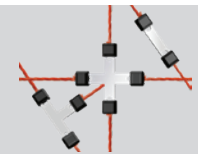

Simple and fast repairs due to our Litzclip® Repair Set

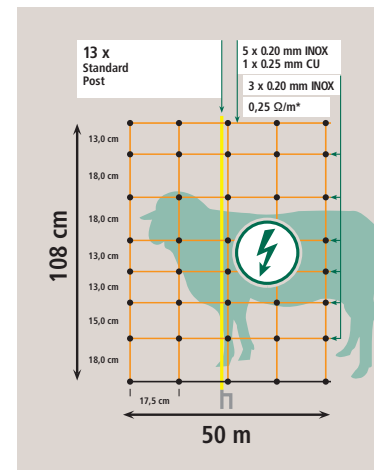
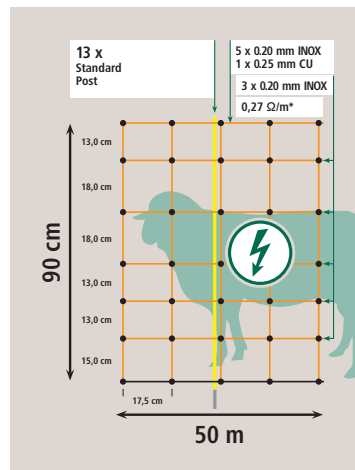
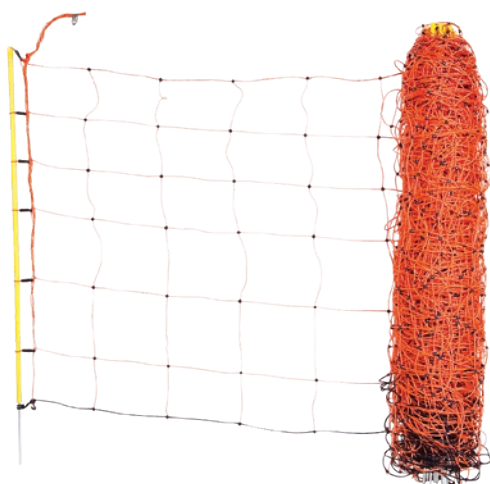

\* Based on the total conductor cross-section of all live poly wires in the pasture netting

Ref. no.	Ground Spike	Length	Height	Colour	Qty Posts	matching replacement post			€
27900	Single Prong	50 m	90 cm	orange	13	27301	1	30	
27901	Double Prong	50 m	90 cm	orange	13	27303	1	30	
27902	Single Prong	50 m	108 cm	orange	13	27305	1	30	
27903	Double Prong	50 m	108 cm	orange	13	27304	1	30	



Scan the QR code for further information



## The return of wolves

The spread of the wolf in the cultivated landscape holds a potential for conflict. As food opportunists, they prey on animals that they can capture most easily - but if the hunger is great enough or the deterrent not strong enough, they are quite willing to expend considerable effort to reach their hunting target. These are, above all, domestic animals such as sheep and goats. This makes protecting the herd an important issue. Whereas the focus used to be on guarding livestock, it is now imperative that the entry of wolves from the outside is also taken into account when building fences. Wolves are very quick to learn and are always developing new strategies to overcome enclosures. Pasture fences should therefore be adequately protected against them jumping or climbing over, slipping through or digging under them. Wolf defence experts agree that electric fences are the best means of choice for keeping wolves at bay.

Generally speaking, herd protection measures are required for livestock species that are particularly at risk from wolves, such as sheep and goats. To create a wolf-deterrent minimum level of protection, the setup of electrically charged utility mesh or wire fences with a minimum height of 90 cm is required. Please also be aware that different specifications may apply, including in relation to requirements, depending on the federal state or region. Other requirements and information can also be found in DIN VDE Standard 0131, as well as the Electric Fence Guidelines VDE SPEC 90006 in their respective most recent version.

## Signalling Band

- Signalling band: early visual scaring of wolves as an additional safety function for your sheep!
- Material: Plastic

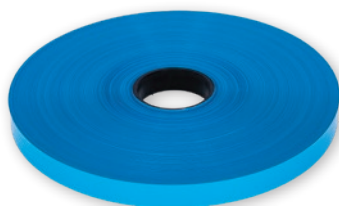

Ref. no.	Colour	Length	Width		€
27240	blue	250 m	25 mm	1	

## Herd Protection Band

- herd protection band for additional visual and acoustic deterrence
- made from 100 % recycled materials
- Material: Plastic

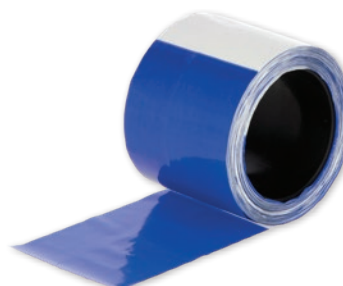

Ref. no.	Colour	Length	Width		€
27239	blue / white	100 m	80 mm	1/12	



### 3 possible applications in one solution:

- as dig-under protection = mounting on the post 20 cm above ground at a 90° angle (Item 1.A), retract and electrify the wire - fix at 0° angle (Item 1.B) for mowing, removing, or rolling up the net
- as jump-over protection = mounting on the top end of the post at a 45° angle (Pos. 2), retract the wire and electrify it
- as height extension = mounting on the top end of the post at a 0° angle (Item 3), retract the electrified wire or signal tape

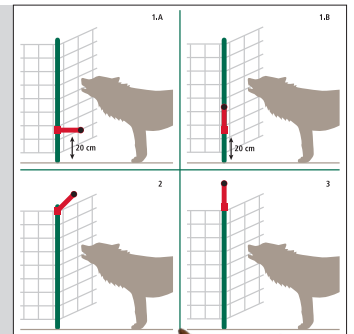

## Supplementary Set for Pasture Nets WolfStop

The flexible and safe solution against wolves and foxes: can be used as tunnelling and jump-over protection as well as to extend the height of the net and reliably keeps predators at bay!

- 10-piece set for mounting on all commercially net posts
- supports can be secured in their holders at 3 defined angles
- the net can be rolled up easily and put to one side/stored by locking the support parallel to the post (position 1.B)
- the conductor material line (electrified) made possible by the WolfStop keeps the wolf away from the net and therefore away from the animals being protected
- if the WolfStop is used mainly as a height extension, then a signal tape (item 27240, optionally available) can be used for scaring purposes
- the additional conductor material line must be operated with the same device as the net itself
- in the case of horned sheep and goats, a distance strand can be drawn on the inside of the net to the electrified wolf defence fence
- mounted on posts in the poultry netting and equipped with an electrified wire, the WolfStop also keeps foxes away from the poultry run (mounting in position 1.A, ideally close to the ground)
- can be used for: posts max. 16 mm diameter



Awarded the silver DLG Innovation Prize in 2022

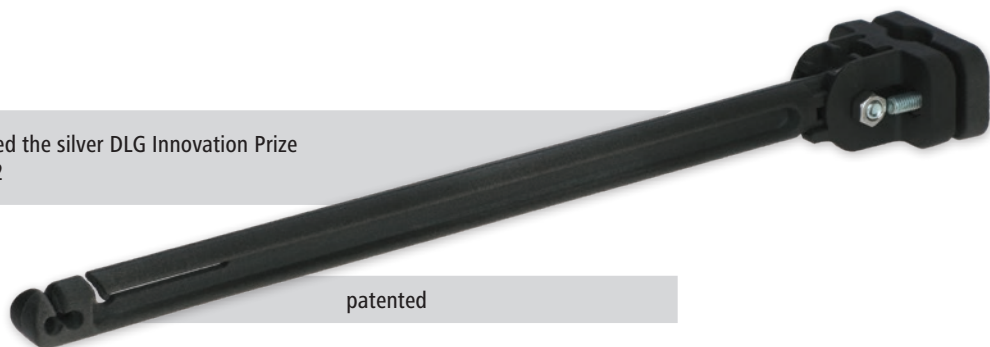

patented

Ref. no.  €  
27256 1/56

Set consisting of: 10 x support, 10 x connecting terminal, 10 x screw and nut set (M5)



Ref. no.	Description	Colour	Material	Length	Width		€
27240	Signalling Band	blue	Plastic	250 m	25 mm	1	
449312	Poly Wire Premium WildHog	blue		400 m		1/6	

# AKO TitanNet Premium XBraid

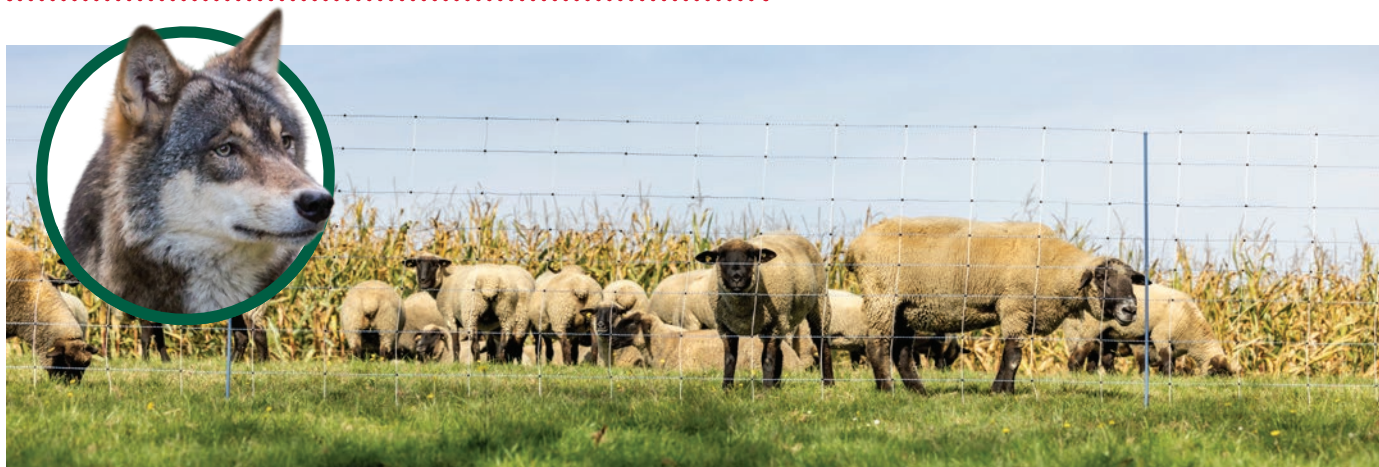

## AKO TitanNet Premium XBraid

Our professional net with extremely robust, braided wires!

- height 122 cm with 9 horizontal braided wires, with stainless steel and copper conductors
- 14 extremely robust and stable PREMIUM posts with galvanised ground tip
- conductor material in the stranded wire runs continuously on the outside and always ensures optimum contact when animals touch it
- high tensile strength and robustness of the wires make this net particularly durable
- easy assembly and disassembly thanks to the combination of PREMIUM posts and robust braided wires, resulting in fewer tangles
- improved footing and optimal terrain adaptation thanks to stable vertical struts every 30 cm
- particularly good visibility due to the colour combination of blue/white - ideal for use when defending against wild animals and wolves
- additional thick, tin-plated copper conductors in the differently coloured 2nd wires from the top ensure minimum electrical resistance and maximum conductivity
- optionally connectable, reinforced grounding wire for earthing along the whole length of the net under difficult ground conditions (e.g. very sandy or dry soils), as well as to prevent wild animal damage

3-year UV stability warranty



Made in the EU



### THE wolf defence net for professional sheep and goat farmers!

- The combination of braided wires and the innovative PREMIUM posts make this net the ideal solution for professional users, including for protecting livestock.
- This combines the advantages of rigid vertical struts, particularly robust posts and braided wires instead of the usual twisted strands: the result is a particularly durable net with excellent conductivity and stability.

Easy and fast repairs with our new Litzclip connectors.

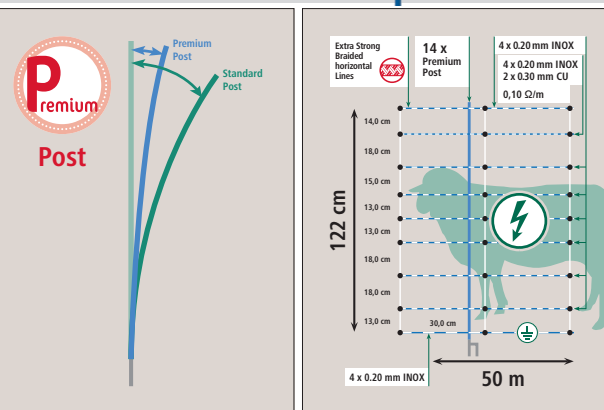

Extremely robust and durable thanks to the use of braided wires



...compared with normal braided wire

\* Based on the total conductor cross-section of all live poly wires in the pasture netting

Ref. no.	Ground Spike	Length	Height	Colour	Qty Posts	matching replacement post		€
27840	Single Prong	50 m	122 cm	white / blue	14	27808	1 24	
27841	Double Prong	50 m	122 cm	white / blue	14	27809	1 24	

# AKO TitanNet Premium Plus



Important: for wolf defence, the first live wire must run max. 20 cm above the ground.

## AKO TitanNet Premium Plus

Our „all-rounder“ from the TitanNet series with the new patented PREMIUM posts.

Equipped with the new PREMIUM net posts, we combine in this new net the proven strengths of our TitanNet sheep nets with versatile connection options for professional use in sheep rearing. Vertically, rigid plastic struts are used instead of the soft wire material. These are permanently linked at intervals of 30 cm with the horizontal wires, ensuring a compact structure even on hilly and uneven terrain.

- height 90 cm (7 horizontal wires) or 108 cm (8 horizontal wires)
- 14 extremely robust and stable PREMIUM posts with galvanised ground tip
- extremely stable welded knots
- strengthened, energized upper poly wire - increased conductivity thanks to the use of 5 stainless steel wires and a tin-plated copper wire
- we offer a 3-year warranty against UV damage for all plastic poly wires
- optionally connectable, reinforced grounding poly wire for earthing along the whole length of the net under difficult ground conditions (e.g. very sandy or dry soils)
- in addition, the 2nd poly wire above the ground is fitted with a separate stainless steel connection terminal, and can therefore be used flexibly
- particularly good visibility due to the colour combination of blue/white - ideal for use when defending against wild animals and wolves

3-year UV stability warranty



Made in the EU



Connection options:

- ground wire (conductive) can be connected to the device's earth output, for additional earthing along the entire length of the net
- 2. wire above ground can optionally be disconnected from the power circuit of the wires positioned above it, to decrease power leakage in heavy vegetation

16 stainless steel conductors combined with thick PE threads in the grounding poly wire prevent browsing by game

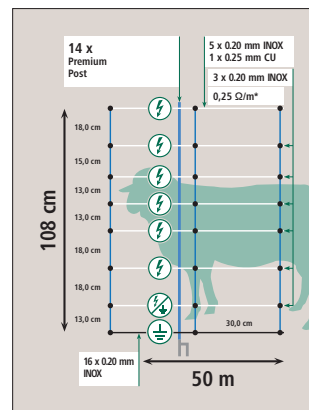
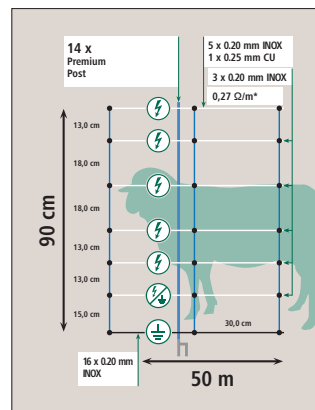
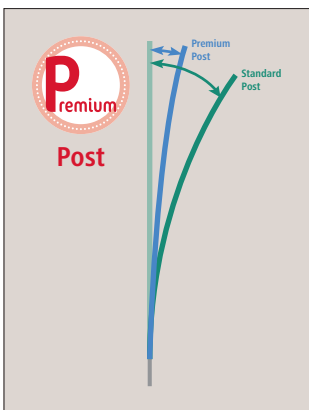

Scan the QR code for further information



\* Based on the total conductor cross-section of all live poly wires in the pasture netting

Ref. no.	Ground Spike	Length	Height	Colour	Qty Posts	matching replacement post	€
27821	Double Prong	50 m	90 cm	blue / white	14	27805	24
27823	Double Prong	50 m	108 cm	blue / white	14	27807	24

# AKO TitanNet Premium Vario



Important: for wolf defence, the first live wire must run max. 20 cm above the ground.

## AKO TitanNet Premium Vario

Our versatile wolf defence net from the TitanNet series with the new patented PREMIUM posts!.

- height 108 cm (8 horizontal wires) or 122 cm (9 horizontal wires)
- extremely durable PREMIUM posts for maximum stability and weather resistance, with galvanised ground prong
- rigid vertical struts in every mesh of the net provide improved stability and maintain the height of the net, even when the ground is very unlevel
- equipped with a particularly high number of excellently conductive copper and stainless steel conductors, this net boasts extremely low resistance (0.04 or 0.05 Ohm/m) and therefore keeps the protected animals inside the fence, and also keeps away attackers from outside
- optimised protection certainty even under extremely bad ground and earthing conditions, thanks to plus/minus switching in the net
- the different horizontal rows of the net are connected to the power and earth of the fence device, so they enable the maximum possible repellent shock when the animal makes contact with two rows or has no ground contact during a jump

3-year UV stability warranty 

Made in the EU 

Ref. no.	Ground Spike	Length	Height	Colour	Qty Posts	matching replacement post		€
27830	Single Prong	50 m	108 cm	white / blue	14	27806	24	
27831	Double Prong	50 m	108 cm	white / blue	14	27807	24	
27832	Single Prong	50 m	122 cm	white / blue	14	27808	24	
27833	Double Prong	50 m	122 cm	white / blue	14	27809	24	



## +/- principle – more intensive pulses for maximum security.

In plus/minus fence systems, the conductors are connected alternately to the fence terminal (+) and the earth terminal (-) of your electric fence unit via conductor bundling clips. The resulting earth wires intensify the electric shock to the animal even in difficult ground conditions, such as dry, sandy or snow-covered ground.

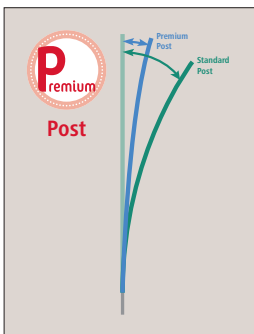
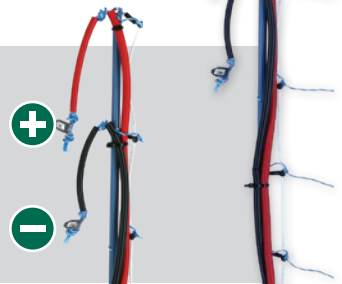

## Connection options:

- PLUS net
- PLUS net with earthing via the grounding wire
  - improved grounding for dry soils
  - strong electric shock when the grounding wire and the conductive wire above it are contacted simultaneously during an attempt to burrow underneath
- PLUS/MINUS net



Scan the QR code for further information

The sketches display the optional connection configuration as +/- net. Naturally, these nets can also be operated as a conventional PLUS net, as long as the first current-carrying wire is not positioned more than 20 cm above ground (wolf defence!).

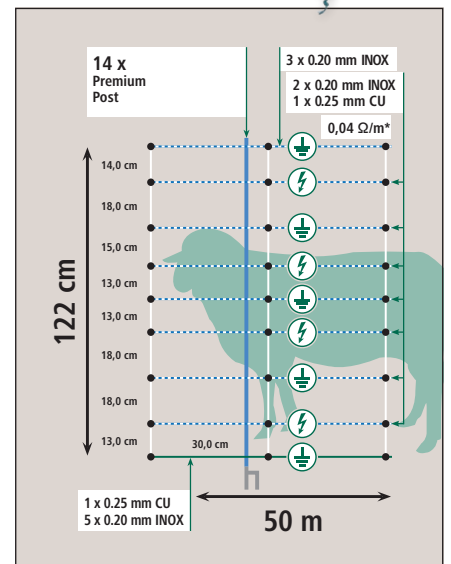
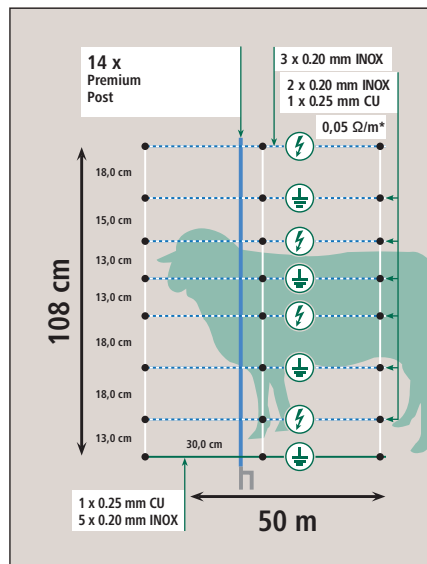

\* Based on the total conductor cross-section of all live poly wires in the pasture netting

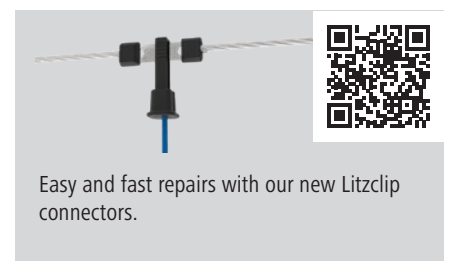
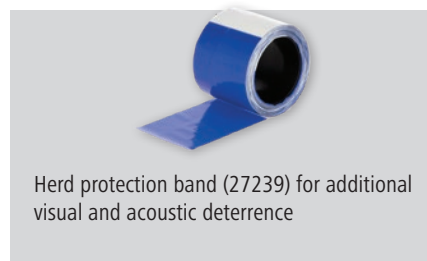

## AKO Titan Light Premium



### AKO Titan LIGHT Premium

- height 90 cm (5 horizontal wires) or 108 cm (6 horizontal wires)
- extremely durable PREMIUM posts for maximum stability and weather resistance, with galvanised ground prong
- rigid vertical struts in every mesh of the net provide improved stability and maintain the height of the net, even when the ground is very unlevel
- equipped with the particularly conductive combination of copper and stainless steel wires, this net boasts super-low resistance (from 0.08 Ohm/m), thus keeping the animals being protected inside the fence, and also keeping away attackers from outside
- additional thick, galvanised copper conductors in the differently coloured 1st and 2nd wires from the top ensure minimum electrical resistance and maximum conductivity
- optionally connectable, reinforced ground wire for earthing along the whole length of the net under difficult ground conditions (e.g. very sandy or dry soils) increases protection certainty and protects against wild animal damage
- excellent conductivity thanks to large number of conductor wires

New product

NEW

3-year UV stability warranty



Made in the EU



Ideal separations between the current-carrying horizontal lines fulfil official requirements for flock protection.

To ensure basic protection, at least four current-carrying conductors must be arranged at heights of 20 cm, 40 cm, 60 cm and 90 cm with maximum row spacing of 20 cm to 60 cm and 30 cm above.

- increased mesh spacings - less power leakage in heavy vegetation
- easy handling due to light weight
- stable plastic struts for optimum stability - even in hilly terrain
- ground game and hedgehogs can "slip through" without risk

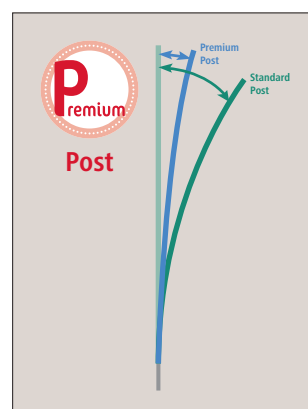
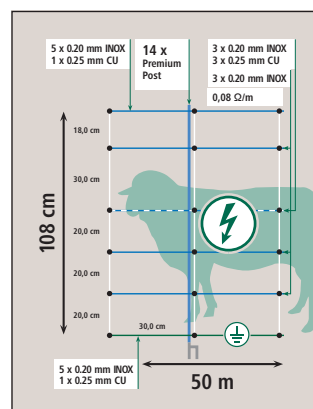
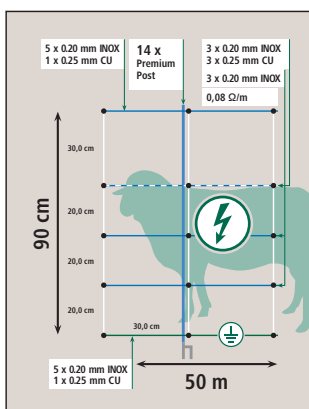

\* Based on the total conductor cross-section of all live poly wires in the pasture netting

Ref. no.	Ground Spike	Length	Height	Colour	Qty Posts	matching replacement post			€
27865	Single Prong	50 m	90 cm	blue / white	14	27804	1	30	
27864	Double Prong	50 m	90 cm	blue / white	14	27805	1	30	
27867	Single Prong	50 m	108 cm	blue / white	14	27806	1	30	
27866	Double Prong	50 m	108 cm	blue / white	14	27807	1	30	

## AKO TitanNet 145

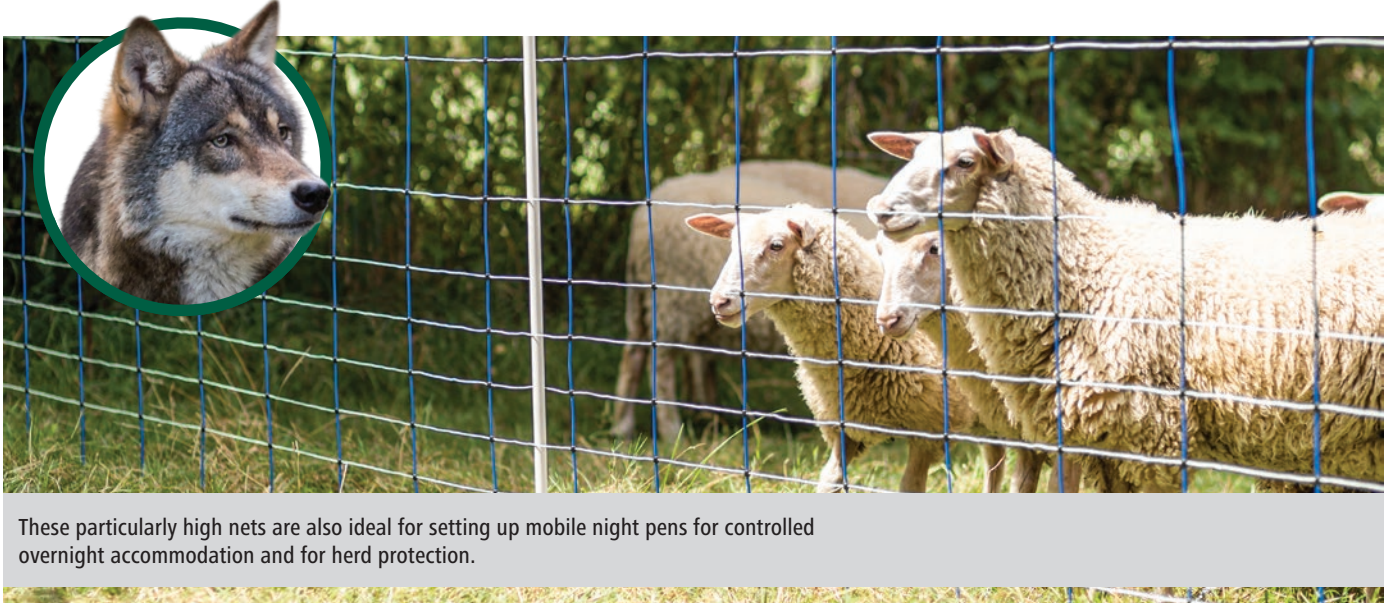

These particularly high nets are also ideal for setting up mobile night pens for controlled overnight accommodation and for herd protection.

### AKO TitanNet 145

Maximum height for maximum (wild animal) protection - our highest net from the TitanNet series.

- height 145 cm (11 horizontal wires)
- extra-strong posts with 19 mm diameter and galvanised ground prong (double prong) ensure a secure, firm stand
- rigid vertical struts in every mesh of the net provide improved stability and maintain the height of the net, even when the ground is very unlevel
- equipped with the particularly conductive combination of copper and stainless steel wires, this net boasts super-low resistance (0.25 Ohm/m) and therefore keep the animals being protected inside the fence, and also keeps away attackers from outside
- reinforced, current-carrying top wire as a lifeline for the entire net - increased conductivity throughout the entire course of the net
- the particularly high netting makes it almost impossible to jump over and penetrate from outside
- the exceptional height makes the net suitable even for keeping ponies, donkeys or alpacas
- available in 2 different lengths, therefore flexible for various applications

3-year UV stability warranty



Made in the EU



#### Connection options:

- ground wire (conductive) can optionally be connected to the device's earth output, for additional earthing along the entire length of the net

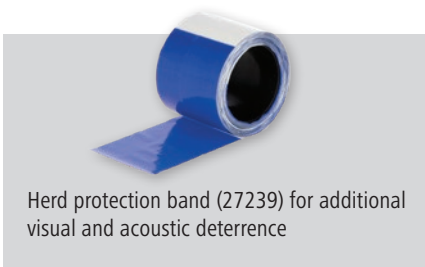



Herd protection band (27239) for additional visual and acoustic deterrence

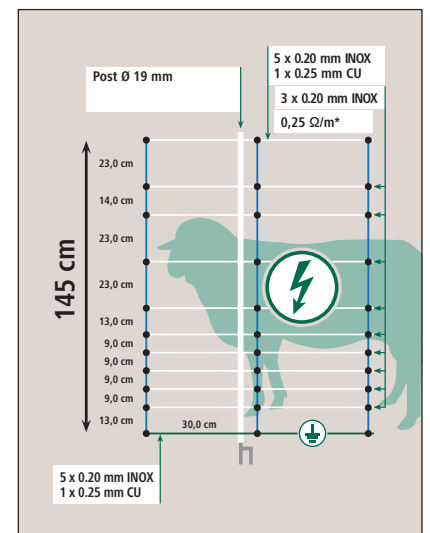

Easy and fast repairs with our new Litzclip connectors.



\* Based on the total conductor cross-section of all live poly wires in the pasture netting

Ref. no.	Ground Spike	Length	Height	Colour	Qty Posts	matching replacement post			€
27910	Double Prong	25 m	145 cm	blue / white	8	27360	1	28	
27380	Double Prong	50 m	145 cm	blue / white	15	27360	1	24	

## AKO OviNet Maxi



### AKO OviNet Maxi

Our OviNet especially for wolf defence

- height 122 cm (10 horizontal poly wires)
- robust plastic posts with galvanised bottom tip
- high-quality, long-lasting plastic wires, both horizontally and vertically, which are welded very firmly to one another
- with their excellent conductivity, the durable TriCond conductor wires allow electrification throughout the net
- high net in combination with narrow mesh, especially in the lower area, make the net particularly secure against intruders from outside AND prevent smaller animals from slipping through
- weight benefit compared with titanium nets of this height

3-year UV stability warranty



Made in the EU



#### Connection options:

- ground wire (conductive) can optionally be connected to the device's earth output, for additional earthing along the entire length of the net

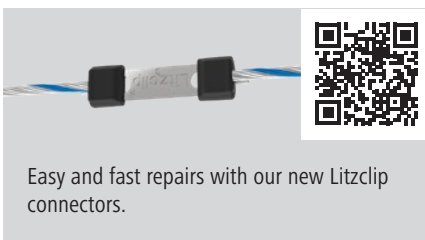

TriCOND conductor wires are 5 times more conductive than standard stainless steel wires of the same diameter, and therefore provide maximum security – even over long stretches. The special coating on these wires makes the material more robust and ensures long durability.

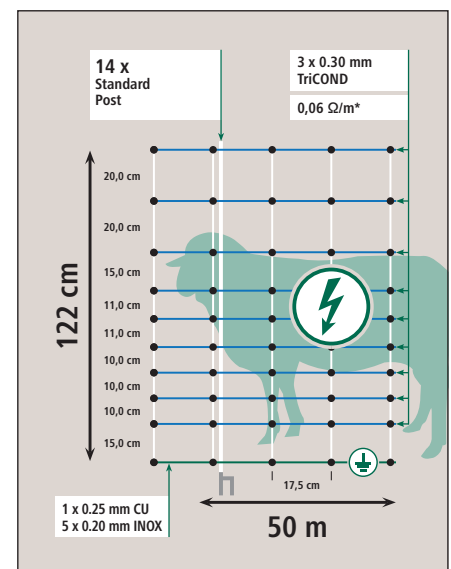

\* Based on the total conductor cross-section of all live poly wires in the pasture netting

Ref. no.	Ground Spike	Length	Height	Colour	Qty Posts	matching replacement post	€
27388	Single Prong	50 m	122 cm	white / blue	14	27376	30
27394	Double Prong	50 m	122 cm	white / blue	14	27375	30

# AKO OviNet 170



## AKO OviNet 170

Our 170 cm high net for maximum jump-over protection

- extra high, electrifiable fence for optimum protection of your animals - ideal for sheep, lambs and pets
- 25 m length for flexible adaptation to various runs and terrain
- robust fibreglass posts with double prong ensure a particularly stable hold in windy conditions and on soft ground
- effective wildlife protection: keeps foxes, wolves and other animals safely away from the fence
- weatherproof and UV-stable - suitable for year-round outdoor use

3-year UV stability warranty



New product

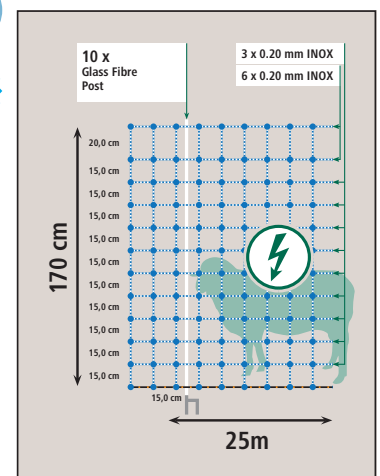

Ref. no.	Ground Spike	Length	Height	Colour	Qty Posts			€
27986	Double Prong	25 m	170 cm	blue / white	10	1	20	
Ref. no.	Description	Ground Spike	Colour	Material	Post height			€
292341	Spare Post	Double Prong	white	Fibreglass	170 cm	1/20		

available from: March 2026

## AKO WildNet



### Wild animal deterrent guide

Browse our AKO wild animal deterrent guide online or request your free copy by e-mail at [info@kerbl.com](mailto:info@kerbl.com)



patented

Made in the EU



### AKO WildNet

The straightforward solution for keeping wild animals at bay!

- height 63 cm ex-works ( 3 horizontal wires); can be extended to height 73 cm by inclusion of an additional top row
- the durable conductor wires allow electrification throughout the net with excellent conductivity
- 12x especially light and robust fibreglass posts with reinforced single prong, post spacing approx. 4.5 m
- particularly good visibility due to the colour combination of blue/white - ideal for keeping wild animals at bay, because easily visible to them
- rigid vertical struts every 60 cm in the the net provide improved stability and maintain the height of the net, even when the ground is unlevel
- 25 mm blue signal tape is available as a separate accessory (250 m), item no. 27240

3-year UV stability warranty



#### The advantages of WildNet:

- quicker to assemble and disassemble than conventional electric fences
- ground clearance (better for mowing and significantly fewer diversions, i.e. more power to the fence)
- blue 25 mm plastic signal tape (250 m, item no. 27240) can be added to improve visibility
- nets are easy to connect with each other (the connector is integrated into the net, separate connectors are not required)

In windy areas, we recommend that you cut the signal tape (27240) into several pieces (approx. 50 – 100 cm) and secure each piece to the top of each post. The fluttering of the tape in the wind keeps wild boar at bay more effectively.

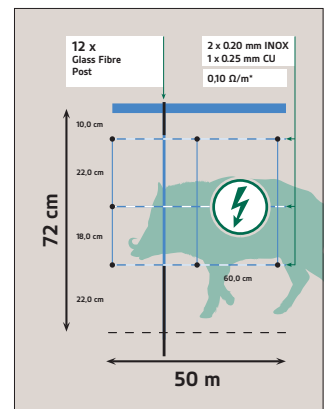
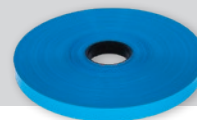

\* Based on the total conductor cross-section of all live poly wires in the pasture netting

Recommended! For the best possible securing of your fence, we recommend: Mobil Power AN 6000 (441136) starter kit



Ref. no.	Ground Spike	Length	Colour	Qty Posts	matching replacement post			€	
27215	Single Prong	50 m	white / blue	12	27217	1	70		
Ref. no.	Description	Ground Spike	Colour	Material	Post height	Length	Width		€
27217	Spare Post	Single Prong	blue	Fibreglass	90 cm			1/10	
27240	Signalling Band		blue	Plastic		250 m	25 mm	1	
44428	Spare Insulator for Oval Steel Post		black	Plastic				1/25/1000	

# Fish Otter Net



## Otter net

- height 50 cm with 9 horizontal wires
- robust plastic posts with galvanised bottom tip
- high-quality, long-lasting plastic wires, both horizontally and vertically, which are welded very firmly to one another
- the reduced size of the mesh also prevents young animals from passing through
- the corrosion-resistant stainless steel conductors allow the net to be electrified, and this keeps potential intruders out
- the net's blue/white colouring is especially visible to wild animals
- the first wire above the ground can be connected separately - either for earthing under difficult ground conditions for improved protection certainty (dryness or snow) - or non-electrified to allow amphibians and small animals to pass without danger
- net fence can be erected and removed much more quickly than a protective fence made of modular individual components (wires and posts)
- electrified net of this height reliably repels otters by preventing them from digging under and climbing over the fence

New product

NEW

3-year UV stability warranty



Made in the EU

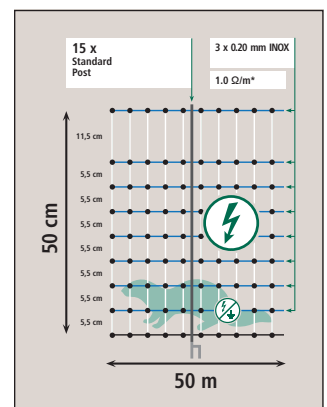
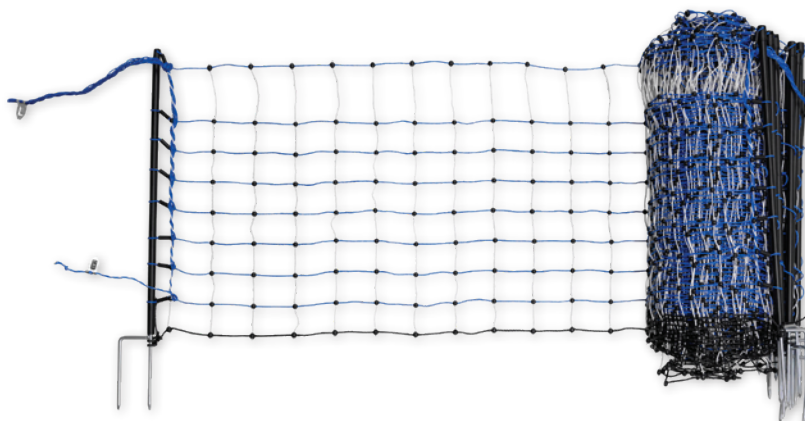

\* Based on the total conductor cross-section of all live poly wires in the pasture netting

Ref. no.	Ground Spike	Length	Height	Colour	Qty Posts			€
292228	Double Prong	50 m	50 cm	blue / white	15	1	16	



This mobile horse fence should always be electrified when in use!

## Mobile Horse Fence

- flexible complete solution to demarcate portion pastures or paddock plots for horses and ponies
- height 120 cm (4 horizontal wires)
- 30 cm ground clearance prevents unwanted discharge where there is vegetation
- white colouring is clearly visible to horses
- extra-strong jumbo posts with 19 mm diameter and galvanised bottom tip (double prong)
- for mobile fencing of horses, several nets can be combined with each other
- head insulator and ground stopper make self-loosening of the poly wire virtually impossible
- rigid vertical struts in every mesh of the net provide improved stability and maintain the height of the net, even when the ground is very unlevel



3-year UV stability warranty



Made in the EU

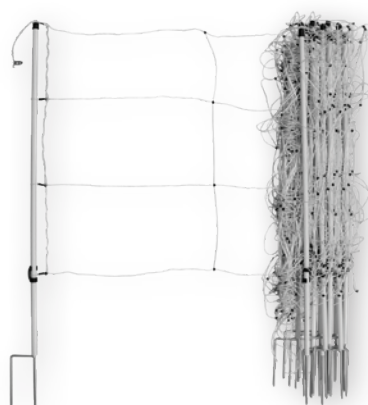
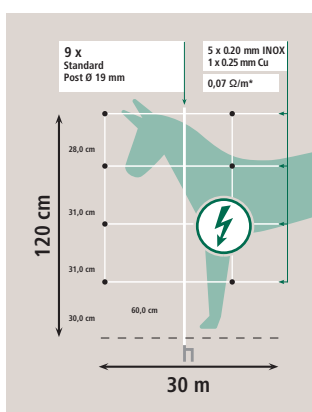

Ref. no.	Ground Spike	Length	Height	Colour	Qty Posts	matching replacement post			€
27939	Double Prong	30 m	120 cm	white	9	27360	1	30	

# Poultry and small animal netting

## Pasture net summary

Ref. no.	Model	Page	horizontal colour	vertical colour										
292414	PoultryNet Premium	234	●	●	25 m	106 cm	●			●	●			●
292420	PoultryNet Premium	234	●	●	50 m	106 cm	●			●	●			●
292419	PoultryNet Premium	234	●	●	25 m	106 cm	●			●	●			●
292418	PoultryNet Premium	234	●	●	50 m	106 cm	●			●	●			●
292410	PoultryNet Premium	234	●	●	50 m	122 cm	●	●		●	●			●
292411	PoultryNet Premium	234	●	●	50 m	122 cm	●			●	●			●
292412	PoultryNet Premium	234	●	●	50 m	122 cm	●	●		●	●			●
292413	PoultryNet Premium	234	●	●	50 m	122 cm	●			●	●			●
292270	PoultryNet	235	●	●	50 m	106 cm		●		●	●			●
292271	PoultryNet	235	●	●	50 m	106 cm			●	●	●			●
292274	PoultryNet	235	●	●	15 m	106 cm			●	●	●			●
292273	PoultryNet	235	●	●	25 m	106 cm			●	●	●			●
292272	PoultryNet	235	●	●	50 m	106 cm			●	●	●			●
292279	PoultryNet	235	●	●	25 m	106 cm			●	●	●			●
292276	PoultryNet	235	●	●	50 m	106 cm		●		●	●			●
292278	PoultryNet	235	●	●	50 m	106 cm			●	●	●			●
292340	PoultryNetMaxi	236	●	●	25 m	170 cm			●	●	●			●
292226	CampingNet	240	●	●	20 m	80 cm		●		●	●	●	●	●
292227	CampingNet	240	●	●	20 m	80 cm			●	●	●	●	●	●
292229	Rabbit Netting	241	●	●	12 m	65 cm		●		●	●			●
292216	Rabbit Netting	241	●	●	25 m	65 cm		●		●	●			●
292221	Rabbit Netting	241	●	●	50 m	65 cm		●		●	●			●
292222	Rabbit Netting	241	●	●	50 m	65 cm			●	●	●			●



Length



Single Prong



can be electrified



Height



Double Prong



with PREMIUM Post



Spare parts for pasture nets can be found at the end of the catalogue!



## AKO PoultryNet Premium

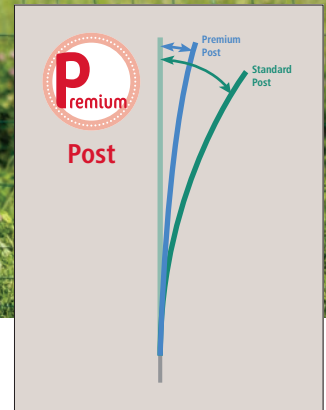

### AKO PoultryNet Premium

- available in electrifiable and non-electrifiable designs
- height 106 cm (11 horizontal wires) or 122 cm (12 horizontal wires)
- extremely durable PREMIUM posts which have been integrated into the net at the factory, with galvanised ground prong for maximum stability
- flexible plastic strands, both vertically and horizontally, are easy to handle
- the especially small mesh, especially in the lower part of the net, prevents smaller or young animals from slipping through the fence
- suitable for chickens, geese, turkeys, as well as dogs or lambs

Made in the EU



3-year UV stability warranty



### AKO PoultryNet Premium

can be electrified

- the corrosion-resistant stainless steel conductors allow the net to be electrified, which improves protection certainty for the animals within the net, and keeps potential intruders out

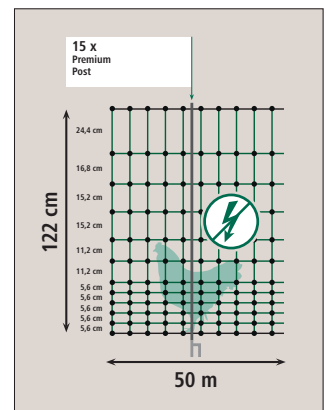
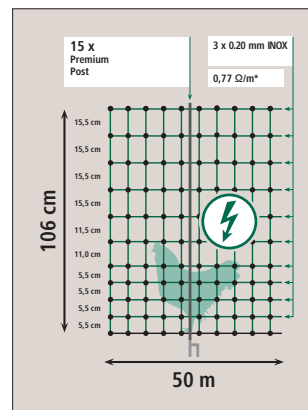

Ref. no.	Ground Spike	Length	Height	Colour	Qty Posts	matching replacement post		€
292414	Double Prong	25 m	106 cm	green	9	292401	1 30	
292420	Double Prong	50 m	106 cm	green	15	292401	1 16	
292412	Single Prong	50 m	122 cm	green	15	292407	1 18	
292413	Double Prong	50 m	122 cm	green	15	292408	1 18	

we recommend the use of electrifiable nets for turkeys and geese

### PoultryNet Premium

not electrifiable

Ref. no.	Ground Spike	Length	Height	Colour	Qty Posts	matching replacement post		€
292419	Double Prong	25 m	106 cm	green	8	292401	1 30	
292418	Double Prong	50 m	106 cm	green	15	292401	1 16	
292410	Single Prong	50 m	122 cm	green	15	292407	1 18	
292411	Double Prong	50 m	122 cm	green	15	292408	1 18	

\* Based on the total conductor cross-section of all live poly wires in the pasture netting

# PoultryNet

## Poultry Netting

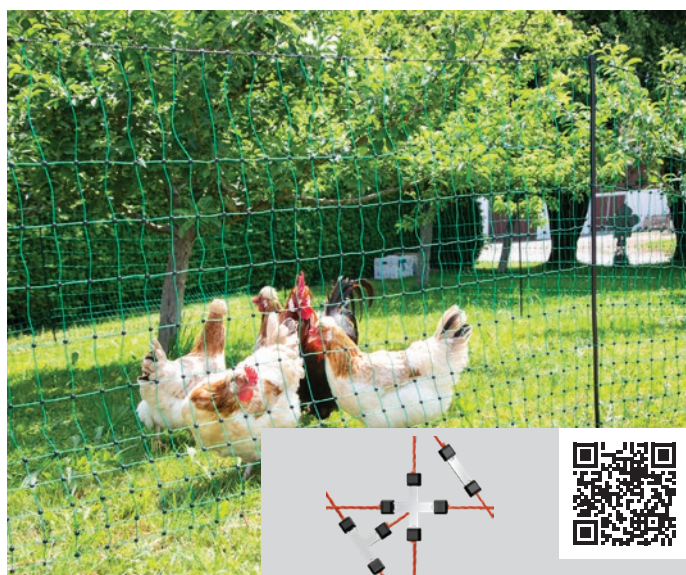

Simple and fast repairs due to our Litzclip® Repair Set

### PoultryNet

- for hens, geese, turkeys
- welded knots
- strengthened top strand
- particularly small mesh width in the lower area of the net
- sturdy plastic posts with galvanised ground spike
- also suitable for lambs
- available in electrifiable and non-electrifiable designs
- we offer a 3-year warranty against UV damage for all plastic wires

Made in the EU



3-year UV stability warranty

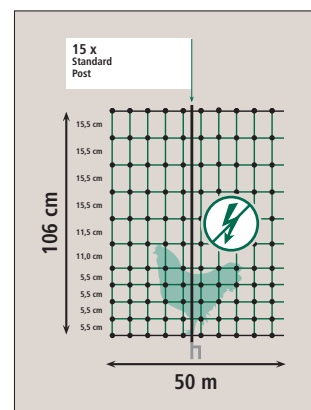
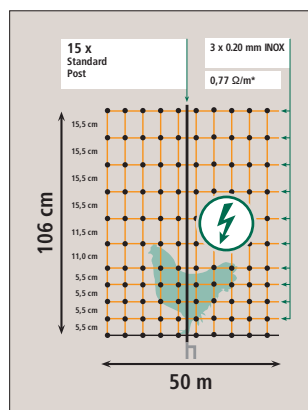

### PoultryNet

can be electrified

Ref. no.	Ground Spike	Length	Height	Colour	Qty Posts	matching replacement post			€
292270	Single Prong	50 m	106 cm	orange	15	292282-7	1	16	
292271	Double Prong	50 m	106 cm	orange	15	292281-7	1	16	
292274	Double Prong	15 m	106 cm	green	6	292281-5	1	40	
292273	Double Prong	25 m	106 cm	green	9	292281-5	1	30	
292272	Double Prong	50 m	106 cm	green	15	292281-5	1	16	

we recommend the use of electrifiable nets for turkeys and geese

### PoultryNet

not electrifiable

Ref. no.	Ground Spike	Length	Height	Colour	Qty Posts	matching replacement post			€
292279	Double Prong	25 m	106 cm	green	8	292281-5	1	30	
292276	Single Prong	50 m	106 cm	green	15	292282-5	1	16	
292278	Double Prong	50 m	106 cm	green	15	292281-5	1	16	

\* Based on the total conductor cross-section of all live poly wires in the pasture netting

# AKO PoultryNet Maxi



## AKO PoultryNet Maxi

Narrow meshes and maximum height - our 170 cm poultry/all-round net.

- extra high, electrified fence for optimum protection of your animals - ideal for poultry, lambs and pets
- 25-metre length for flexible adaptation to various runs and terrain
- robust fibreglass posts with double prong ensure a particularly stable hold in windy conditions and on soft ground
- fine-meshed base area reliably prevents young animals from slipping through
- effective wildlife protection: keeps foxes, wolves and other animals safely away from the fence

3-year UV stability warranty



New product

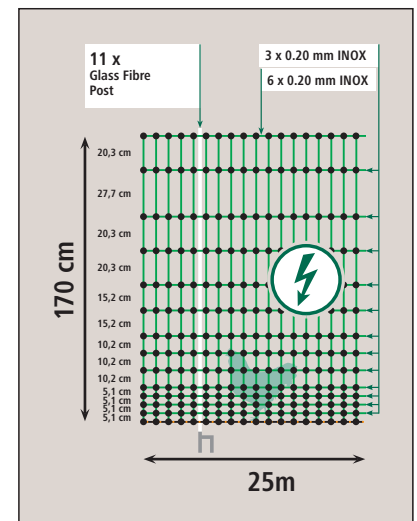

Ref. no.	Ground Spike	Length	Height	Colour	Qty Posts		€
292340	Double Prong	25 m	170 cm	green	11	1 30	
Ref. no.	Description	Ground Spike	Colour	Material	Post height		€
292341	Spare Post	Double Prong	white	Fibreglass	170 cm	1/20	

available from: March 2026



A carefully thought-out concept and the range of products compiled by experts makes this set a real worry-free package!

## PoultryNet All-In-One Kit Solar

The complete set, with all necessary components for installing an electrified mesh quickly and easily to protect poultry, dogs, cats or rabbits. With 0.4 Joules of charging energy in the solar-powered device and a close-meshed net, the animals being protected and garden are safe.

- no time-consuming modular purchases, all parts required conveniently in one box
- Solar device with Joule input: 0.4 J with intelligent battery management with deep discharge protection: 2 weeks run time without sun and long battery life
- net with particularly small mesh width in the lower area, as well as stable plastic posts with galvanised bottom tip
- the set includes the matching ground post, a multi-level fence tester and all required cables. the set also includes the electric fence warning sign, which is always required and must be attached in a clearly visible place on the mesh
- can be set up and dismantled in just a few minutes without the need for any special tools

Set includes: 1 x poultry net green, 50 metres, height 106 cm, double prong (3-year warranty for UV resistance of the wire), 1 x Sun Power S 250 solar device, incl. 12 Volt, 3 Watt solar module, 1 x AGM battery, 12 Volt, 4 Ah (6-month warranty), 1 x 230 Volt power pack for recharging or battery maintenance during the winter months, 1 x ground connection cable (black), 1 x fence connection cable crocodile clip (red), 1 x earth rod, 1 x mesh repair kit, 1 x fence tester, 1 x warning sign, 1 x assembly instructions



Ref. no.			€
441154	1	12	



## PoultryNet All-In-One Kit 230 V

The all-round worry-free package, with all necessary components for installing an electrified mesh quickly and easily to protect poultry, dogs, cats, or rabbits. With 1.0 joule charging energy in the power supply and a close-meshed net, the animals to be protected and the garden are safe.

- no time-consuming modular purchases, all parts required conveniently in one box
- 230 Volt power supply with 1.0 Joule Input: compact device with unrestricted protection period thanks to mains operation
- net with particularly small mesh width in the lower area, as well as stable plastic posts with galvanised bottom tip
- the set includes the matching ground post, a multi-level fence tester and all required cables. the set also includes the electric fence warning sign, which is always required and must be attached in a clearly visible place on the mesh
- can be set up and dismantled in just a few minutes without the need for any special tools

Set includes: 1 x poultry net green, 50 metres, height 106 cm, double prong (3-year warranty for UV resistance of the wire), 1 x Fence Device 230 Volt Mains Operation Compact Power N 700 (5 year warranty), 2 x 10 m underground cable (for connecting the device to the net and the earthing), 1 x Wire Connecting Clamp (for Connecting Fence Supply Line and Pasture Net), 1 x earth rod, 1 x mesh repair kit, 1 x fence tester, 1 x warning sign, 1 x assembly instructions



Ref. no.			€
441155	1	12	





## Twist Butler Netting Winder

The fantastic all-round helper for the day-to-day handling of pasture nets: it allows easy setup and dismantling of the nets and offers a handy solution for storage!

- easy and at the same time practical solution for setting up and dismantling pasture nets
- equivalent to a reel system for nets
- can be used for all nets up to 125 cm tall incl. ground nails and 50 m length
- the removable crank means that the rolled-up nets can be transported and stored standing up in a space-saving and orderly manner on the plates
- pasture nets can be handled daily without the use of force or outside help thanks to the Twist Butler

Made in Germany



Ref. no.	Description		€
27940	1 base element (plate and rod) with one crank	1	
27942	2 Base Elements (Plate and Rod)	1	

Ref. no.	Description		€
27941	single crank	1/31	

27941





## Support Post for Field Netting

- ideally suited as supporting start and end posts, or for stabilising corners of pasture netting
- the post is simply pushed into the corners, and the net is thereby tensioned
- solid post made of galvanised round steel (ø 14 mm), with foot lug
- post tapered at the bottom for easier penetration into the earth
- jacketing with robust plastic tube (ø 20 mm) prevents power leakage (if electrifiable nets are used)

Utility model application registered!



Ref. no.	Description	Total Height	Post Ø	Length Ground Nail	MOQ	Pieces / unit			€
27340	up to a height of 90 cm	120 cm	14 mm	25 cm	4 pieces	4 / pack	1/4	1,000	
27350	from a height of 90 cm	145 cm	14 mm	25 cm	4 pieces	4 / pack	1/4	500	

## Door for Electric Fence Nets

### can be electrified

Enables quick and easy passage through fence netting. Practical door for your electric netting. Quick and easy to install. Can be installed to any position on the netting - can also be installed subsequently to a fence that has already be set up. The green netting of the door is electrifiable, the stable frame is insulated. When opening the door, the power does not have to be turned off.

- fast and easy to open and close
- low weight, despite being sturdy and robust
- opening width: 86 cm (sufficient for most gardening equipment)
- incl. 2 jumbo standing posts, double-pointed
- electrifiable, incl. cable and connections
- quick and easy installation
- delivery includes connection and connection accessories

446517: suitable for all nets up to 106 cm in height

446518: extra-high version, suitable for a net height of over 95 cm up to 125 cm.

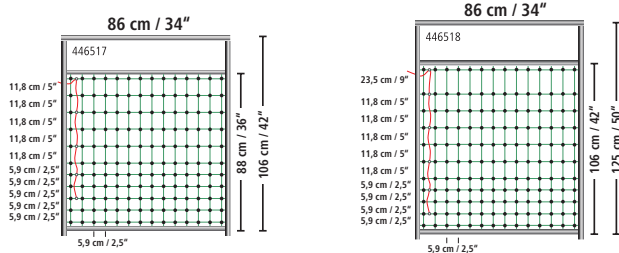

incl. connector accessories for optional electrification of the green net (the frame is insulated and can still be touched)



incl. underground cable



Ref. no.	Description	Width	Height		€
446517	for nets up to 106 cm	86 cm	106 cm	1	
446518	for nets from 95 - 125 cm	86 cm	125 cm	1	

## Complete Net-door Kit

This gate handle kit allows you to expand your fence with an easy-to-open gate that allows quick access to your animals on your pasture or in your garden.

- the kit is easy to handle and install: it fits on net posts with a diameter of 11 mm to 19 mm, supports all types of pasture netting and is compatible with electric and non-electric netting
- in a few minutes, a cut-through can be created in your netting fence that is as customised as your net itself and the gate therefore fits all possible widths and nets
- if the netting is electrified, the current does not need to be switched off to enter the pasture or to gain access to your animals: the extremely sturdy and generous handle allows you to walk through the gap in the fence without removing the electrification from the netting
- perfectly coordinated components made from long-lasting materials create a simple and flexible solution for every net
- simply mount on the first and last netting post and thereby create an easy-to-open, customised cut-through between the net ends
- netting and netting posts not included in the scope of delivery

Set consisting of: 2 x handle halves, 1 x foot anchor, 2 x netting post hooks, 3 x foot anchor pegs, 2 x guy ropes, 2 x guy pegs

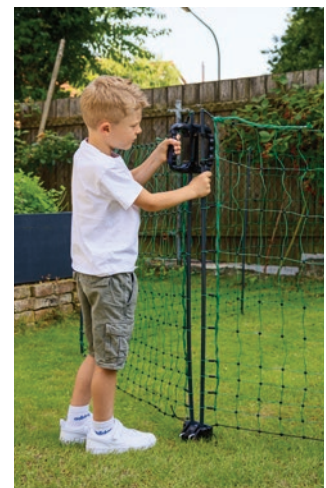

Ref. no.		€
446532	1/12	

# CampingNet



## Boundary Fence Camping Net

The net is the perfect companion for camping holidays with dogs or other four-legged companions. Even small animals cannot fit through the narrow meshes. It can also be used to protect or demarcate flower beds, vegetable gardens and so on.

- for mobile fencing of camping pitches when pets or small animals are present
- as a border and protection for flower beds, vegetable gardens, green spaces, ponds
- fast and simple assembly and removal
- practical complete set incl. transport bag
- particularly narrow meshes in the lower net area ensure that even small animals cannot slip through
- the green net with black posts blends unobtrusively into the surroundings
- 9 sturdy plastic posts with galvanised ground nails
- we offer a 3-year warranty against UV damage for all plastic poly wires
- netting without electrification and therefore purely physical barrier without electricity

3-year UV stability warranty



Made in the EU

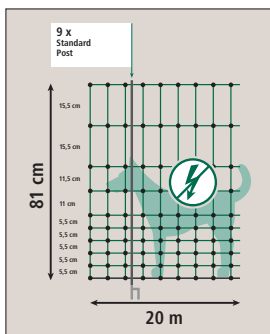

incl. handy transport bag



Ref. no.	Ground Spike	Length	Height	Colour	Qty Posts			€
292226	Single Prong	20 m	81 cm	green	9	1	30	
292227	Double Prong	20 m	81 cm	green	9	1	30	

## RabbitNet



Extra-small mesh width guarantees maximum guarding safety!

### Rabbit Netting

can be electrified

Reliable protection for hares, rabbits and other small animals in the garden that is set up in moments. The extra-fine mesh makes the netting especially safe, while the galvanised ground spikes on the plastic posts ensure an excellent grip in the ground.

- freely configurable outlet for hares, rabbits and other small animals
- discreet green-black colouring fits in beautifully with any garden
- easy setup and dismantling thanks to integrated post with galvanised ground spike
- robust quality thanks to welded knots
- good electricity conduction via long-lasting stainless steel conductor
- extra-fine mesh to protect small animals or to keep unwanted visitors at bay
- we offer a 3-year warranty against UV damage for all plastic poly wires

372005



44657

3-year UV stability warranty



Made in the EU

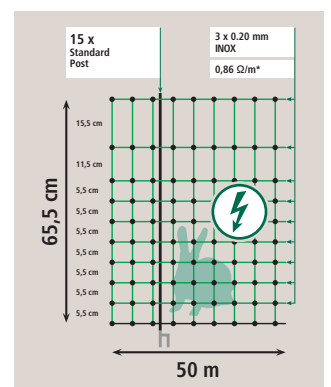

Ref. no.	Ground Spike	Length	Height	Colour	Qty Posts	matching replacement post			€
292229	Single Prong	12 m	65 cm	green	9	292210-5	1	40	NEW
292216	Single Prong	25 m	65 cm	green	9	292210-5	1	30	
292221	Single Prong	50 m	65 cm	green	15	292210-5	1	16	
292222	Double Prong	50 m	65 cm	green	15	292211-5	1	16	

Ref. no.	Description	Ground Spike	Colour	Material	Post height		€
292210-5	Spare Post	Single Prong	black	Plastic	65 cm	1/50	
292211-5	Spare Post	Double Prong	black	Plastic	65 cm	1/50	
372005	Compact Power B 40		green / black			1	
27249-5	Head Insulator for Pasture Netting		black	Plastic		1/10/500	
27250-5	Base Stopper for Pasture Netting		black	Plastic		1/10/500	
44657	Ground/Support Rod			galvanised metal		1	

# Litzclip® The new way of repairing nets quickly.



- no tools required for mounting
- continuous electrification
- easy handling
- secure connection

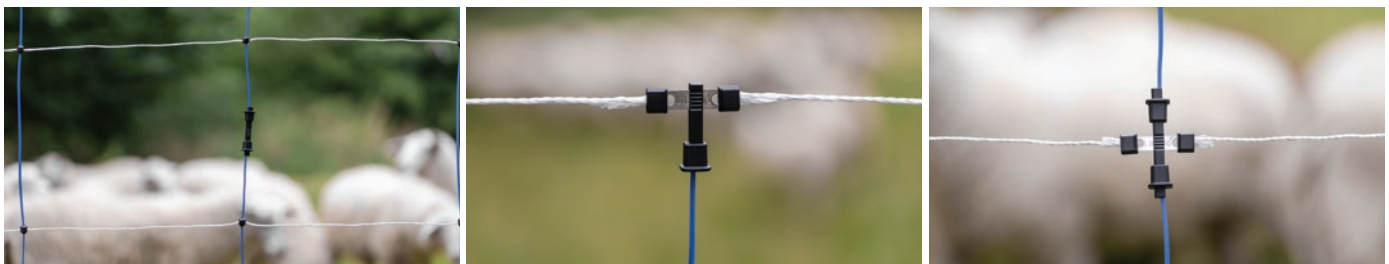
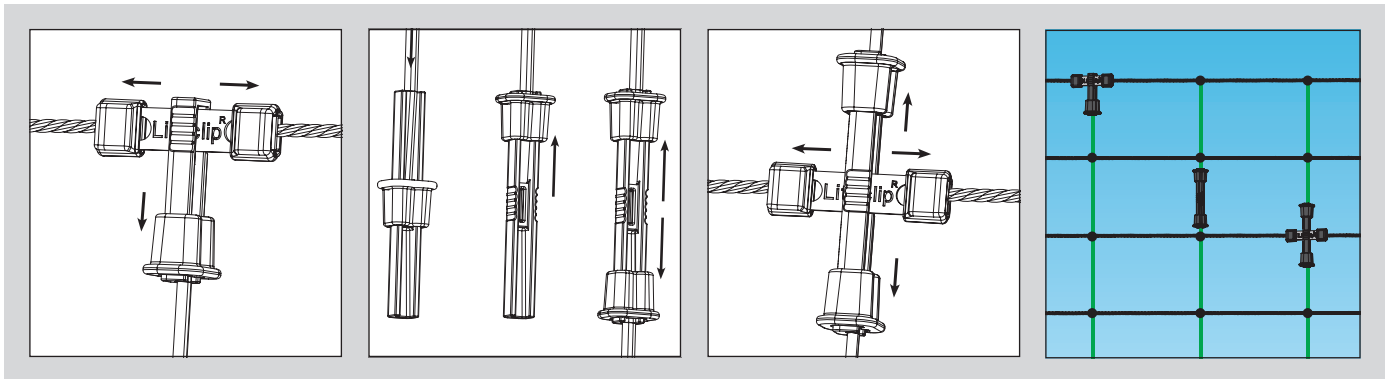
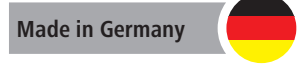

## Litzclip® Vertical Brace Connector for Pasture Nets

- the simple solution for repairing broken vertical struts in pasture nets

Suitable for all standard electric fence systems with rigid vertical struts!

patented





Ref. no.	Description	MOQ	Pieces / unit		€
442005/101	straight	1 pack	10 / pack	1/100	

## Litzclip® Repair Set for vertical Struts in Pasture Nets

- the simple solution for repairing broken vertical struts in pasture nets
- connector plate made from stainless steel

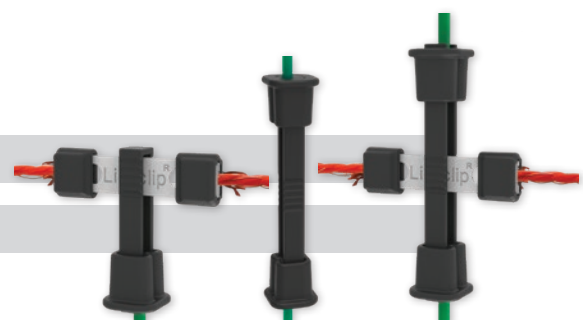
Suitable for all standard electric fence systems with rigid vertical struts!  
patented



Ref. no.	Material	Pieces / unit		€
442020/081	Stainless Steel	1 / pack	1/100	

Set includes: 2 x connector straight, 2 x cross connector, 2 x T-connector

## Poly Wire Connector Litzclip®

- the straightforward solution, even for repairing a torn poly wire
- special key-shaped punched opening for the easy introduction and secure fixing of the poly wire

patented





Ref. no.	Material	can be used for	MOQ	Pieces / unit		€
442003/101	Stainless Steel	poly wire up to Ø 3 mm	1 pack	10 / pack	1/100	

## Poly Wire T-Connector Litzclip®

- suitable for use with all types of poly wire nettings

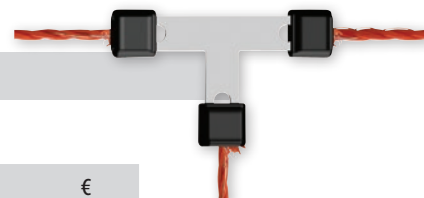
patented



Ref. no.	Material	can be used for	MOQ	Pieces / unit		€
442015/056	Stainless Steel	poly wire up to Ø 3 mm	1 pack	5 / pack	1/100	

## Poly Wire Cross-Connector Litzclip®

- suitable for use with all types of poly wire nettings

patented

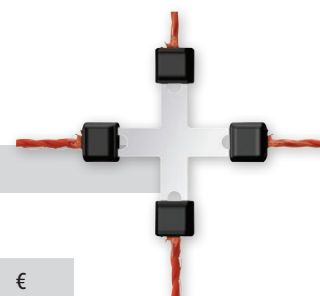

Ref. no.	Material	can be used for	MOQ	Pieces / unit		€
442014/056	Stainless Steel	poly wire up to Ø 3 mm	1 pack	5 / pack	1/100	

## Litzclip® Repair Set

- especially for repairing sheep, poultry and rabbit netting

patented

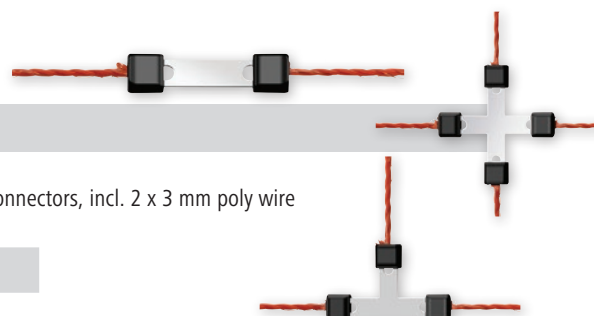

Set includes: incl. 4 x straight 3 mm poly wire connectors, incl. 2 x 3 mm poly wire cross-connectors, incl. 2 x 3 mm poly wire T-connectors

Ref. no.	Material	MOQ	Pieces / unit		€
442018/081	Stainless Steel	1 pack	6 / pack	1/100	





Ref. no.	Description	Ground Spike	Colour	Material	Post height		€
27299	Connector Clip for Pasture Netting					1	
27249-5	Head Insulator for Pasture Netting		black	Plastic		1/10/500	
27250-5	Base Stopper for Pasture Netting		black	Plastic		1/10/500	
27322	Floor Anchor		black	Plastic		1/10/300	
27293	Sheep Netting Rrepair Set		orange			1/100	
27294	Sheep Netting Rrepair Set		green			1/100	
27804	Spare Post	Single Prong	blue	thermoplastic + fibreglass	90 cm	1/50	
27805	Spare Post	Double Prong	blue	thermoplastic + fibreglass	90 cm	1/50	
27806	Spare Post	Single Prong	blue	thermoplastic + fibreglass	108 cm	1/50	
27807	Spare Post	Double Prong	blue	thermoplastic + fibreglass	108 cm	1/50	
27346	Spare Post	Single Prong	green	Plastic	90 cm	1/50	
27347	Spare Post	Double Prong	green	Plastic	90 cm	1/50	
27348	Spare Post	Single Prong	green	Plastic	108 cm	1/50	
27349	Spare Post	Double Prong	green	Plastic	108 cm	1/50	
27202	Spare Post	Single Prong	white	Plastic	90 cm	1/100	
27203	Spare Post	Double Prong	white	Plastic	90 cm	1/50	
27229	Spare Post	Single Prong	white	Plastic	108 cm	1/50	
27230	Spare Post	Double Prong	white	Plastic	108 cm	1/50	
27201	Spare Post	Single Prong	yellow	Fibreglass	105 cm	1/50	
27301	Spare Post	Single Prong	yellow	Plastic	90 cm	1/50	
27303	Spare Post	Double Prong	yellow	Plastic	90 cm	1/50	
27305	Spare Post	Single Prong	yellow	Plastic	108 cm	1/50	
27304	Spare Post	Double Prong	yellow	Plastic	108 cm	1/50	
27277	Spare Post	Double Prong	black	Plastic	90 cm	1/50	
27279	Spare Post	Double Prong	black	Plastic	108 cm	1/50	
27217	Spare Post	Single Prong	blue	Fibreglass	90 cm	1/10	
292341	Spare Post	Double Prong	white	Fibreglass	170 cm	1/20	



27250-5  
Replacement Floor  
Stopper



27249-5  
Spare head insulator



27322  
Floor Anchor



Ref. no.	Description	Ground Spike	Colour	Material	Post height		€
27299	Connector Clip for Pasture Netting					1	
27249-5	Head Insulator for Pasture Netting		black	Plastic		1/10/500	
27250-5	Base Stopper for Pasture Netting		black	Plastic		1/10/500	
27322	Floor Anchor		black	Plastic		1/10/300	
27804	Spare Post	Single Prong	blue	thermoplastic + fibreglass	90 cm	1/50	
27805	Spare Post	Double Prong	blue	thermoplastic + fibreglass	90 cm	1/50	
27806	Spare Post	Single Prong	blue	thermoplastic + fibreglass	108 cm	1/50	
27807	Spare Post	Double Prong	blue	thermoplastic + fibreglass	108 cm	1/50	
27808	Spare Post	Single Prong	blue	thermoplastic + fibreglass	122 cm	1/50	
27809	Spare Post	Double Prong	blue	thermoplastic + fibreglass	122 cm	1/50	
27375	Spare Post	Double Prong	white	Plastic	122 cm	1/50	
27376	Spare Post	Single Prong	white	Plastic	122 cm	1/50	
27360	Spare Post	Double Prong	white	Plastic	145 cm	1/25	



Ref. no.	Description	Ground Spike	Colour	Material	Post height		€
27299	Connector Clip for Pasture Netting					1	
27249-5	Head Insulator for Pasture Netting		black	Plastic		1/10/500	
27250-5	Base Stopper for Pasture Netting		black	Plastic		1/10/500	
27322	Floor Anchor		black	Plastic		1/10/300	
292401	Spare Post	Double Prong	grey	thermoplastic + fibreglass	106 cm	1/50	
292407	Spare Post	Single Prong	grey	thermoplastic + fibreglass	122 cm	1/50	
292408	Spare Post	Double Prong	grey	thermoplastic + fibreglass	122 cm	1/50	
292341	Spare Post	Double Prong	white	Fibreglass	170 cm	1/20	
292282-7	Spare Post	Single Prong	orange	Plastic	106 cm	1/50	
292281-7	Spare Post	Double Prong	orange	Plastic	106 cm	1/50	
292282-5	Spare Post	Single Prong	black	Plastic	106 cm	1/50	
292281-5	Spare Post	Double Prong	black	Plastic	106 cm	1/50	



Ref. no.	Description	Ground Spike	Colour	Material	Post height		€
27322	Floor Anchor		black	Plastic		1/10/300	
27299	Connector Clip for Pasture Netting					1	
292210-5	Spare Post	Single Prong	black	Plastic	65 cm	1/50	
292211-5	Spare Post	Double Prong	black	Plastic	65 cm	1/50	
27249-5	Head Insulator for Pasture Netting		black	Plastic		1/10/500	
27250-5	Base Stopper for Pasture Netting		black	Plastic		1/10/500	

# Keyword Index

- 2**  
230 Volt Power Pack ..... 39  
230 Volt Power Pack for 9 Volt Battery Units ..... 68  
2K EDX Ring Insulator ..... 165
- 3**  
32 Premium AGM Battery ..... 80
- 7**  
7 x 7 m Tournament / Paddock Set ..... 77
- A**  
A 1200 Mobil Power ..... 45  
A 2000 Power ..... 47  
AD 2000 digital Mobil Power ..... 41  
AD 3000 digital Mobil Power ..... 41  
AD 5000 digital Mobil Power ..... 41  
Adaptor Cable ..... 67  
Additional Insulator for Oval Fibreglass Post ..... 155  
AKOtronic S7K ..... 30  
Allgäu Winder Insulator ..... 169  
ALU GUARD Fence Wire ..... 124  
AN 4000 Mobil Power ..... 43  
AN 550 Compact Power ..... 75  
AN 6000 Mobil Power ..... 43  
Angular Steel Post ..... 152  
Anti-Theft-Box ..... 65
- B**  
B 290 Power Shock ..... 71  
B 40 Compact Power ..... 75  
B 500 plus Power Shock ..... 71  
B180 Compact Power ..... 73  
B260 multi Compact Power ..... 73  
Basic Plastic Post ..... 162  
Battery Charger ..... 78  
Battery Tester ..... 80  
BD 400 digital Power Station ..... 69  
BD 600 digital Power Station ..... 69  
Bentonit Earthing Mix ..... 89  
Big Euro Reel ..... 97  
Boundary Fence Camping Net ..... 240
- C**  
Camping Net Boundary Fence ..... 240  
Cavallo Tape Corner Insulator ..... 170  
Cavallo Tape Corner Insulator ..... 147, 177  
Chain Tensioner ..... 130  
Charge Insulator for round and oval Steel Posts ..... 179  
ClassicNet ..... 219  
Clip Insulator Premium ..... 171  
Clip Insulator ..... 177  
Clip Insulator Easy Tape ..... 172  
Clip Insulator Maxi Tape ..... 172  
Closing Option for Pasture Gate Mounting Set ..... 198  
Combi Insulator Premium ..... 169, 183  
Compact Power AN 550 ..... 75  
Compact Power B 40 ..... 75  
Compact Power B180 ..... 73  
Compact Power B260 multi ..... 73  
Compact Power N 700 ..... 75  
Compact Reel ..... 98  
Compact Ring Insulator ..... 167  
compact Round Fibreglass Post ..... 155  
Compact Wide Tape Insulator ..... 173  
compact+ Round Fibreglass Post ..... 155  
Complete Net-door Kit ..... 239  
Connector for Pasture Panels ..... 205  
Corner connector for pasture panels ..... 204  
Corner Insulator ..... 172  
Corner Insulator for Wire and Rope ..... 175  
Corner Insulator Premium ..... 147, 175, 176  
Corner Solution for Fixed Fences ..... 128  
Corner/Stretch Insulator Premium ..... 170  
Cover for Pasture Gates ..... 198  
Crocodile Clip ..... 93  
Cut-Out Switch ..... 94
- D**  
De-tensioning Isolator for Electric Rope175  
De-tensioning Set „Diagonal“ ..... 128  
De-tensioning Set „Horizontal“ ..... 128  
Digital Defect Finder ..... 83  
Digital DUO Voltmeter ..... 83  
Distance Insulator ..... 181  
Distance Insulator T-Post ..... 145  
Door for Electric Fence Nets ..... 239  
Dry Battery ..... 81  
Dry Battery Alkaline 9 Volt ..... 5, 81  
DUO Power Pack All Weather ..... 31  
Duo Power X 1000 ..... 38  
Duo Power X 1600 smart ..... 37  
Duo Power X 2500 ..... 38  
Duo Power X 4000 ..... 38  
Duo Power X 6000 smart ..... 35  
Duo Power Xi 8000 ..... 35  
Duo Power Xi 8000 smart ..... 35
- E**  
E-Line Gate System ..... 193  
Earthing Mix Bentonit ..... 89  
Easy Cord Rope Insulator ..... 174  
Easy Drill EDX Ring Insulator ..... 166, 167  
Easy Drill EDX Slit Insulators ..... 168  
Easy Drill SX green Ring Insulator ..... 169  
Easy Tape Clip Insulator ..... 172  
EasyNet ..... 216  
Eco Euro Reel ..... 97  
Eco Gate System ..... 193  
Eco Plastic Post ..... 162  
EconomyLine Fencing Tape Double Pack ..... 110  
EconomyLine Monowire ..... 117  
EconomyLine Poly Wire ..... 116  
EconomyLine Polywire Cross-wound ..... 117  
EconomyLine Rope ..... 113  
EconomyLine Tape ..... 110  
Electric Cattle Gate Electro Gate ..... 194  
Electrics Kit for Fence Gates ..... 199  
Electro Gate Electric Cattle Gate ..... 194  
Euro Cord Rope Insulator ..... 174  
Euro Reel ..... 97  
Euro Reel Big ..... 97  
Euro Reel Eco ..... 97  
Euro Tape Insulator ..... 173  
Expert Plastic Post ..... 160  
Extension Cable Set ..... 63  
Eyelet Metal Post ..... 151
- F**  
Farming Forceps Standard ..... 130  
Fence-Checker ..... 85  
Fence Clip ..... 189  
Fence Connection Cable, double ..... 91, 92  
Fence Connection Cable, triple ..... 91, 92  
Fence Connector Cable Heart Clip ..... 93  
Fence Panel with Gate ..... 203  
Fence Power/Ground Connector Cable ..... 87  
Fence Starter Set T-Post ..... 143  
Fence Tester ..... 85  
Fence Tester with LED Display ..... 84  
Fence Tester, 8-tier ..... 85  
Fence Wire ALU GUARD ..... 124  
Fencing Tape Double Pack EconomyLine ..... 110  
Fin Tube Insulator ..... 130  
Fixing Clips for T-posts ..... 148  
FlexiGate ..... 191  
FlexiGate 19 m ..... 191  
Fodder Rack ..... 208  
Four-sided Manger for Palisade Feeding Grid ..... 206
- G**  
Gate / Start Insulator ..... 177  
Gate / start Insulator for Tapes Premium ..... 183  
Gate / Start Insulator Premium Vario ..... 182  
Gate / Start Insulator Vario ..... 182  
Gate / Tensioning Isolator TITAN ..... 185  
Gate connector for pasture panels ..... 204  
Gate Handle ..... 186, 187  
Gate Handle Premium ..... 186
- Gate Handle Premium BIG green ..... 187  
Gate Handle Premium with Litzclip® Tape Connector ..... 188  
Gate Handle Premium with Rope and Wire Connector ..... 189  
Gate Handle Soft Grip ..... 186  
Gate Handle with Litzclip® Connector ..... 188  
Gate Handle with Litzclip® Tape Connector 188  
Gate Handle with Rope and Wire Connector ..... 189  
Gate Handle with Tape Connector ..... 189  
Gate Insulator ..... 184  
Gate Insulator T-Post ..... 146  
Gate Insulator T-Post Vario ..... 146  
Gate Insulator X<sup>3</sup> ..... 176, 184  
Gate Insulator X<sup>3</sup> Premium ..... 182  
Gate Lock ..... 192  
Gate Set Premium FLEXIGATE green 5, 190  
Gate Spring Kit ..... 192  
Gate System E-Line ..... 193  
Gate System Eco ..... 193  
Gear-Toothed Wire Tensioner ..... 129  
Geared Reel 3:1 ..... 98  
Ground and Fence Connector Cable 91, 92  
Ground Connection Cable ..... 93  
Ground rod 2-part ..... 89  
Ground/Support Rod ..... 74
- H**  
Hand Pile Driver ..... 133  
Hay Bell for Round Bales ..... 209  
Hay Net for Round Bales ..... 209  
Head Insulator T-Post ..... 144  
Head Insulator Tape/Rope Corner Solution T-Post ..... 144  
Herd Protection Band ..... 220  
High-power on/off Switch ..... 94  
High Energy Saline Dry Battery 9 Volt ..... 80  
High Voltage Cable Connector ..... 87  
High Voltage Underground Cable ..... 86, 87  
High Voltage Underground Cable Premium 86  
Highland Permanent Fencing Insulator 174  
Hobby Square Hay Rack ..... 207  
Hobby Square runner with safety feeding grille ..... 207  
Hobbysset ..... 76
- I**  
Insulator ..... 166  
Insulator Euro Tape ..... 173  
Insulator for double Wire Mesh Fence ..... 181  
Insulator Pinlock ..... 174  
Iron Wire ..... 125
- L**  
L smart Solar Station ..... 53  
L Solar Station ..... 53  
Lightning Protection ..... 94  
Lightning Protection Device ..... 94  
Litzclip® Poly Wire Connector ..... 119, 243  
Litzclip® Poly Wire Cross-Connector ..... 243  
Litzclip® Poly Wire T-Connector ..... 243  
Litzclip® Rope Connector ..... 119  
Litzclip® Safety Link for Electric Rope ..... 119  
Litzclip® Tape Connectors ..... 118  
Litzclip® Tape Gate Handle Connector ..... 188  
Locking Spike for Pasture Gates ..... 199  
Long-handle Clip Insulator ..... 177, 180  
Longitudinal connector for pasture panels 204
- M**  
Maxi Tape Clip Insulator ..... 172  
Metal Battery Boxes ..... 65  
Metal Box Assembly Kit ..... 63  
Metal Post T-Post ..... 142  
Mobil Power A 1200 ..... 45  
Mobil Power AD 2000 digital ..... 41  
Mobil Power AD 3000 digital ..... 41  
Mobil Power AD 3000 digital Starter Kit48  
Mobil Power AD 5000 digital ..... 41  
Mobil Power AN 4000 ..... 43
- Mobil Power AN 6000 ..... 43  
Mobil Power AN 6000 Starter Kit ..... 49  
Mobile Horse Fence ..... 232  
Monowire EconomyLine ..... 117  
Mounting Clamp for round Posts ..... 177  
Mounting Set for Pasture Gates ..... 198  
Multi-adjustable pasture gate ..... 197  
Multi Post ..... 99
- N**  
N 1200 Power ..... 29  
N 3500 Power ..... 29  
N 4800 Power ..... 29  
N 700 Compact Power ..... 75  
Nail Insulator ..... 179  
NDi 12000 smart ..... 25  
NDi 15000 smart ..... 25  
Netting Winder ..... 238  
Ni 10500 ..... 27  
Ni 14500 ..... 27  
Ni 6500 ..... 27
- O**  
OctoWood ..... 137  
Offset Pigtail Insulator ..... 181  
Offset Ring Insulator ..... 176, 180  
Offset Rope Insulator ..... 180  
Offset Tape Insulator ..... 180  
One-Hand Drop Aid ..... 96  
Otter net ..... 231  
Oval Fibreglass Post ..... 154  
Oval Fibreglass Post Premium BLUE ..... 153  
OviNet ..... 218  
OviNet 170 ..... 229  
OviNet Maxi ..... 228  
OviNet Premium ..... 217
- P**  
Panel Cover Penetration Protection ..... 205  
Pasture Gate adjustable ..... 195, 196  
Pasture Gate adjustable for Horse Owners 197  
Pasture Panel ..... 202  
Pasture Shelter Complete Set for Sheep and Goats ..... 201  
Permanent Fencing Insulator Highland 174  
Pinlock Insulator ..... 174  
Pinlock Insulator T-Post ..... 144  
Plastic Eyelets ..... 155  
Plastic Post ..... 162  
Plastic Post Basic ..... 162  
Plastic Post Eco ..... 162  
Plastic Post Expert ..... 160  
Plastic Post Premium ..... 156  
Plastic Post Titan ..... 158  
Plastic Post Titan Plus ..... 158  
Plastic Post with Stirrup Step ..... 156  
Plastic Reel Super ..... 96  
PlatinumLine Poly Wire ..... 6, 104, 105  
PlatinumLine Rope ..... 103, 105  
PlatinumLine Tape ..... 6, 102  
Poly Wire Connector Litzclip® ..... 119, 243  
Poly Wire Cross-Connector Litzclip® ..... 243  
Poly Wire EconomyLine ..... 116  
Poly Wire on Reel ..... 97  
Poly Wire PlatinumLine ..... 6, 104, 105  
Poly Wire Premium WildHog ..... 115  
Poly Wire PremiumLine ..... 114  
Poly Wire Steuer ..... 117  
Poly Wire T-Connector Litzclip® ..... 243  
Poly Wire TopLine Plus ..... 115  
Polyamide De-tensioning Insulator for Steel Wire ..... 175  
Polywire Cross-wound EconomyLine ..... 117  
Porcelain Corner Insulators ..... 123  
Porcelain Strain Insulator ..... 123  
Portable Fence Kit for Trekking ..... 76  
Post Hole Digger ..... 132  
PoultryNet All-In-One Kit 230 V ..... 237  
PoultryNet All-In-One Kit Solar ..... 237  
PoultryNet Maxi ..... 236  
PoultryNet Premium ..... 234  
Power A 2000 ..... 47  
Power N 1200 ..... 29  
Power N 3500 ..... 29

Power N 4800	29
Power Pack All Weather DUO	31
Power Shock B 290	71
Power Shock B 500 plus	71
Power Station BD 400 digital	69
Power Station BD 600 digital	69
Power Station XDi 10000 smart	33
Power Station XDi 15000 smart	33
Premium AGM 15 Ah Complete Set	80
Premium AGM Battery	79
Premium AGM Battery 32	80
Premium BIG green Gate Handle	187
Premium BIG Ring Insulator	167
Premium BLUE Oval Fibreglass Post	153
Premium Clip Insulator	171
Premium Combi Insulator	169, 183
Premium Corner Insulator	147, 175, 176
Premium Corner/Stretch Insulator	170
Premium FLEXIGATE green Gate Set 5, 190	190
Premium Gate / start Insulator for Tapes	183
Premium Gate Handle	186
Premium High Voltage Underground Cable 86	86
Premium Horse Wire	126
Premium Light Rope	111
Premium Plastic Post	156
Premium Slit Insulators	168
Premium Tape/Rope Tensioner	171
Premium Vario Gate / Start Insulator	182
Premium WildHog Poly Wire	115
PremiumLine Poly Wire	114
PremiumLine Rope	111
PremiumLine Tape	106, 107
Professional ground rod	88
Profi Spring Steel Post	150
Puller for T-Post	149
Pulse Flash	84

**Q**  
Quick Rope/Poly Wire Connector 121, 184, 185

**R**  
Rabbit Netting 241  
Ram for T-Post 149  
Rear Side Spacer Insulator T-Post 145  
Recycled Post cross Profile 139  
Recycling Post round Profile 139  
Recycling Post square Profile 139  
Reel Holder 99  
Reel Super Big 96  
Repair Set 243  
Repair Set for vertical Struts in Pasture Nets 242  
Ring Insulator 166, 167, 176  
Ring Insulator 2K EDX 165  
Ring Insulator Compact 167  
Ring Insulator Easy Drill EDX 166, 167  
Ring Insulator Easy Drill SX green 169  
Ring Insulator Premium BIG 167  
Ring Insulator T-Post 145  
Ring Insulator Vario Classic 178  
Robinia post 135  
Rope / Tape Connector 90  
Rope and Poly Wire Connector 120  
Rope and Wire Tensioner 116  
Rope Connecting Cable 93  
Rope Connector 93, 120  
Rope Connector Litzclip® 119  
Rope Corner Insulator T-Post 147  
Rope EconomyLine 113  
Rope Insulator Easy Cord 174  
Rope Insulator Euro Cord 174  
Rope Insulator T-Post 145  
Rope PlatinumLine 103, 105  
Rope Premium Light 111  
Rope PremiumLine 111  
Rope TopLine Plus 112  
Round Fibreglass Post 154  
Round Fibreglass Post compact 155  
Round Fibreglass Post compact+ 155  
Round Rack with 12 Feeding Slots 208  
Round Rack with 8 Feeding Slots 208

**S**  
S 1000 Sun Power 59  
S 1500 Sun Power 56  
S 2400 smart Sun Power 55  
S 250 Sun Power 60  
S 3000 Sun Power 56  
S 3800 Sun Power 56  
S 4000 smart Sun Power 55  
S 500 Sun Power 59  
S 6 2, 58  
Safety Link for Electric Rope Litzclip® 119  
Saline Dry Battery 9 Volt High Energy 80  
Savanne AM 2000 44  
Savanne AM 3000 44  
Savanne AM 3000 Starter Kit 49  
Screw Insulator Vario Plus 178  
Screwdriver for Ring and Clip Insulator 164  
Sheep Hurdle 200  
Signalling Band 220  
Sledge Hammer 133  
Slit Insulators 168  
Slit Insulators Easy Drill EDX 168  
Slit Insulators Premium 168  
Slow Feeding Net 206  
Smart Satellite 2.0 82  
Soft Grip Gate Handle 186  
Solar Module 4 Watt 64  
Solar Panel 62  
Solar Set 5 Watt 64  
Solar Station L 53  
Solar Station L smart 53  
Solar Station XL smart 53  
Solar Station XXL smart 53  
Solar Unit 55, 56, 60  
Spare Battery 56, 59  
Spare Insulator/additional Insulator 153  
Spare Spring 155  
Special Earth Rod for Mobile Use 88  
Special Ground Rod 88  
Special Steel Wire for Fixed Fence 125  
Special Wet Rechargeable Battery 12 Volt. 78  
Spiral Ground/Retaining Anchor 63  
Spiral Ground/Retaining Anchor for Solar Units 57  
Splint Insulator for angled Steel Post 152  
Spring Steel Post 150  
Spring Steel Post Profi 150  
Spring Steel Post with Eyelets 151  
Square Hay Rack for Horses with Safety Feeding Barrier 206  
Square Hay Rack Hobby 207  
Square runner with safety feeding grille Hobby 207  
Stabiliser for adjustable Pasture Gates 199  
Stake Iron 132  
Standard Farming Forceps 130  
Standard four-sided Rack with Palisade Feeding Grid 207  
Staples 130  
Starter Kit Mobil Power AD 3000 digital 48  
Starter Kit Mobil Power AN 6000 49  
Starter Kit Savanne AM 3000 49  
Stem Eyelet Insulator 181  
Steuer Poly Wire 117  
Stranded Wire 124  
Sun Power S 1000 59  
Sun Power S 1500 56  
Sun Power S 2400 smart 55  
Sun Power S 250 60  
Sun Power S 3000 56  
Sun Power S 3800 56  
Sun Power S 4000 smart 55  
Sun Power S 500 59  
Super Big Reel 96  
Super Plastic Reel 96  
Super Plastic Reel with Handle and Holder for Mounting on Stands 98  
Supplementary Set for Pasture Nets Wolf-Stop 221  
Support Post for Field Netting 238  
Swing-Through Lock for Fence Gates 198

**T**  
T-connector for pasture panels 204  
T-Post Distance Insulator 145

T-Post Fence Starter Set 143  
T-Post Gate Insulator 146  
T-Post Head Insulator 144  
T-Post Head Insulator Tape/Rope Corner Solution 144  
T-Post Metal Post 142  
T-Post Pinlock Insulator 144  
T-Post Premium Tape Gate Insulator Set 146  
T-Post Rear Side Spacer Insulator 145  
T-Post Ring Insulator 145  
T-Post Rope Corner Insulator 147  
T-Post Rope Insulator 145  
T-Post Tape Insulator 144  
T-Post Tape, Rope and Corner Insulator 147  
T-Post Tape/Rope Corner Solution 146  
T-Post Universal Clamp Set 148  
T-Post Universal Clip Set 148  
T-Post Variable Corner Solution Set 143  
T-Post Vario Gate Insulator 146  
Tape Connecting Cable 90  
Tape connector 2-way 90  
Tape Connector 3-way 90  
Tape Connectors 118  
Tape Connectors Litzclip® 118  
Tape Corner Insulator Cavallo 147, 170, 177  
Tape EconomyLine 110  
Tape Gate Handle Connector Litzclip® 188  
Tape Gate Insulator Set T-Post Premium 146  
Tape Insulator T-Post 144  
Tape PlatinumLine 6, 102  
Tape PremiumLine 106, 107  
Tape TopLine Plus 108, 109  
Tape, Rope and Corner Insulator T-Post 147  
Tape/Rope Corner Solution T-Post 146  
Tape/Rope Tensioner Premium 171  
Temperature Equalisation Spring 129  
Tensioning Arm for Wire Tensioner 130  
TITAN Gate / Tensioning Isolator 185  
Titan LIGHT Premium 226  
Titan Plastic Post 158  
Titan Plus Plastic Post 158  
TitanLight Net 215  
TitanNet 214  
TitanNet 145 227  
TitanNet Premium 213  
TitanNet Premium Plus 223  
TitanNet Premium Vario 224  
TitanNet Premium XBraid 222  
TopLine Horse Wire 127  
TopLine Plus Poly Wire 115  
TopLine Plus Rope 112  
TopLine Plus Tape 108, 109  
Tournament / Paddock Set 7 x 7 m 77  
Two-way lock for pasture gates 198

**U**  
Universal Clamp Set T-Post 148  
Universal Clip Set T-Post 148

**V**  
Variable Corner Solution Set T-Post 143  
Vario Classic Ring Insulator 178  
Vario Gate / Start Insulator 182  
Vario Plus Screw Insulator 178  
Vario Wire Dispenser 125  
Vertical Brace Connector for Pasture Nets 242

**W**  
Wall/floor Bracket for Pasture Panels 205  
Warning Sign 95  
Warning Sign – Caution Electric Fence! 95  
Warning Sign – Electric Fence 95  
Wide Tape Insulator 173  
Wide Tape Insulator Compact 173  
Wide Tape Ring Insulator 173  
WildNet 230  
Winder Insulator Allgäu 169  
Wire Connecting Clamp 131  
Wire Connectors 131  
Wire Connectors Wire Link 131  
Wire Dispenser 125  
Wire Dispenser Vario 125  
Wire Link Wire Connectors 131

Wire Tensioner 130  
WolfStop Supplementary Set for Pasture Nets 221  
Wood Screw 164  
Wooden Mallet 133  
Wooden Post Mount 57

**X**  
X 1000 Duo Power 38  
X 1600 smart Duo Power 37  
X 2500 Duo Power 38  
X 4000 Duo Power 38  
X 6000 smart Duo Power 35  
X2 smart 3, 37  
X<sup>3</sup> Gate Insulator 176, 184  
X<sup>3</sup> Premium Gate Insulator 182  
XDi 10000 smart Power Station 33  
XDi 15000 smart Power Station 33  
Xi 8000 Duo Power 35  
Xi 8000 smart Duo Power 35  
XL smart Solar Station 53  
XXL smart Solar Station 53

**Z**  
Zinc-Carbon Dry Battery 81

# The electric fence module with a system from AKO

Our modular system is your best advisor! Informative and wellarranged product presentation makes choosing a lot easier:

- The characteristics that determine the decision to buy are listed on the packaging and shelf labelling
- For more information there are free catalogues and leaflets available.
- We offer selected product samples in special displays for a better „grasping“ of quality and design.



## AKO wild animal deterrent guide

From corn fields ruined by wild boar, fish ponds plundered by otters, or sheep taken by wolves – the topic of wild animal deterrent is not just a perennial issue, but also has additional, new, problematic facets. Electric fences have been proven to provide safe, long-term protection.

In our wild animal deterrent guide „Electric fence – a powerful argument! Wild animal freedom – but only until this point!“, we present an excerpt in words and pictures from our range of wild animal deterrent fence products, customised to the different wild animal types and their specific characteristics: proven practical solutions that ensure a successful and long-term protection function. Easy to understand graphics clarify the features of electric fence set-up, customised to respective wild animal types.

Browse our wild animal deterrent guide online or request your free copy by e-mail to [info@kerbl.com](mailto:info@kerbl.com) We are also happy to personally advise you via telephone at any time.



## AKO wolf defence guide

The spread of the wolf in the cultivated landscape holds a potential for conflict. As opportunist feeders, wolves snatch the animals which they can apparently capture most easily. These are, above all, domestic animals such as sheep and goats. Appropriate measures to protect herds are therefore essential, in order to prevent losses.

Our compact guide is intended to provide you with the most important information, tips, and approaches for effective wolf defence, using electric fences, and also to help you in selecting the right products for the protection of your herd.

Browse our wolf defence guide online, or simply request your free copy by e-mail to [info@kerbl.com](mailto:info@kerbl.com)! We are also happy to personally advise you via telephone at any time.



## AKO tips & tricks for building your own horse paddock

This guide is designed to assist you with the DIY installation of your individual fence system using AKO OctoWood wooden posts and/or T-Post metal posts. In order to get an initial overview of all required fence components, along with the cost, you can enter your paddock fence in our AKO fence calculator, [www.fenceconfigurator.com](http://www.fenceconfigurator.com), and generate a material requirements overview.

Browse our guide online or request your free copy by e-mail to [info@kerbl.com](mailto:info@kerbl.com)! We are also happy to personally advise you via telephone at any time.





5 year warranty on all fence devices!



## Sales/logistics

**Kerbl UK Limited**  
8 Lands End Way  
Oakham, Rutland  
LE15 6RF UK

Phone +44 01572 722558  
Fax +44 01572 757614  
E-Mail [enquiries@kerbl.co.uk](mailto:enquiries@kerbl.co.uk)  
[www.kerbl.co.uk](http://www.kerbl.co.uk)

**Albert Kerbl GmbH**  
Felizenzell 9  
84428 Buchbach  
Germany

Phone +49 8086 933-100  
Fax +49 8086 933-500  
E-Mail [fencing@kerbl.com](mailto:fencing@kerbl.com)  
[www.kerbl.com](http://www.kerbl.com)

## Product information/technical advice

**AKO-Agrartechnik GmbH & Co.KG**  
Karl-Maybach-Str. 4  
88239 Wangen-Geiselharz  
Germany

Phone +49 7520 9660-0  
Fax +49 7520 9660-88  
E-Mail [info@ako-agrar.com](mailto:info@ako-agrar.com)  
[www.ako-agrar.com](http://www.ako-agrar.com)



We are constantly striving to improve our stock of products and keep them right up to date. We reserve the right to make design changes. The publication of this catalogue renders all previous catalogues and prices lists for these products invalid.

All prices provided are the manufacturer's recommended retail prices and are inclusive of VAT. All information is subject to typesetting and printing errors.

Price alterations and errors reserved.

Colours and designs may vary due to printing processes. Reprinting – even just of extracts – is only permitted only with prior consent.

Batteries are accessory items and are therefore not included in the equipment's scope of delivery.

You can significantly improve the tending safety of your paddock with the products listed. Local influences and conditions can affect your fence system, which is why absolute tending safety cannot be guaranteed.

The vendor offers no warranty that the fence system is secure against break-outs; in fact, the safety system should be improved with the electric fence device and corresponding accessories.

Retail only via specialist dealers.

© 12/2025

WK2026-201\_EN\_AKO\_ohne Preis